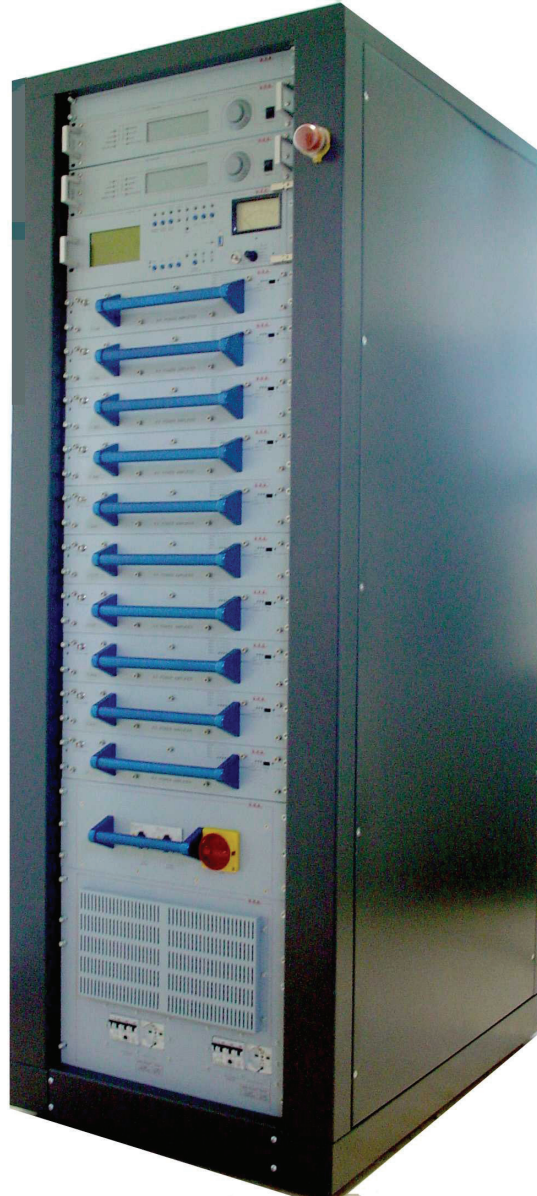

PJ10KPS-C



User & Technical Manual

Manufactured by



Italy





EC Declaration of conformity.

R.V.R. Elettronica S.p.A. declares that this transmitter is in conformity to the essential requirements and to other relevant regulations settled by the 1999/5/CE directive.

Validity of the EC declaration of conformity.

WARNING: the conformity of this product is not valid if the product is used in conditions not authorized by R.V.R. Elettronica as described in the user manual.

Examples of conditions in which the conformity is not valid (indicative list):

The connection between the exciter and the amplifier (i) indicated in the present document is not done properly;

The components used are different from those used and recommended by R.V.R. Elettronica S.p.A.;

The additional devices used are not suitable and/or are generating signals which are not suitable to those supported by the product;

The product is used in operative conditions different from the normal working conditions for which the product was designed (temperature, humidity, supply voltage, ...);

Any modification on parts of the product without any prior authorization from R.V.R. Elettronica S.p.A..

Limitations for the use of the product in the EEC member countries.

This product is a radio transmitter for FM broadcasting .

It can work on operative frequencies which are not harmonized in the EEC member countries.

Whoever uses this product, should obtain the authorization from the spectrum local administrative authority before starting using it.

The user is responsible for the configuration of the working frequency, the output power, and for the other characteristics of the installation to which the transmitter described in the present documentation is part of, in order to respect the limitations described in the authorization received by the competent local authority.

Table of Contents

1	Introduction	1
2	Warranty	2
3	First Aid	3
3.1	Treatment of electrical shocks	3
3.1.1	If the victim is not responsive	3
3.1.2	If victim is responsive	3
3.2	Treatment of electrical Burns	4
3.2.1	Extensive burned and broken skin	4
3.2.2	Less severe burns	4
4	General Description	5
4.1	Composition	5
4.2	Technical specifications	6
4.3	Options	6
4.4	Operating principles	6
5	Installation and use	9
5.1	Assembly	9
5.1.1	Configuration of the alimentation of the PJ10KPS-C	14
5.2	Amplifier check	18
5.2.1	LCD Display	19
5.2.2	Buttons, selector switches and LEDs	20
5.2.3	Analogue instruments	21
5.3	First start	21
5.3.1	Preliminary operation	21
5.3.2	Power-on	21
5.3.3	Control unit settings	22
5.4	Management of the exciters	23
5.4.1	Start-up from power-on with exciters in manual mode	23
5.4.2	From OFF to ON with exciters in manual	23
5.4.3	Automatic changeover	23
5.4.4	Phase from ON to OFF	23
5.4.5	Start-up with exciters in automatic mode	23
5.4.6	Audio alarm	23
5.5	Protection and alarms	23
6	Troubleshooting	23
7	Technical description	23
7.1	Software - Reference guide	23
7.1.1	Overall Status menu	23
7.1.2	Select menu	23
7.1.3	Control Unit menu	23
7.1.4	Power Supply menu	23
7.1.5	R.F. Combiner menu	23
7.1.6	R.F. Units menu	23
7.1.7	Alarms menu	23
7.1.8	Service menu	23
7.1.9	menu	23
7.1.10	Exciters menu	23
7.1.11	Info menu	23

7.1.12	Release menu	23
7.1.13	Modem menu	23
7.2	Parallel Interface	23
7.3	Power supply section	23
7.3.1	Working Principles	23
7.3.2	Configurations	23
7.3.3	Logic control Signals	23
7.3.4	Control card	23
7.3.5	Interface Board	23
7.3.6	Replacing the carriage	23
7.4	RF Modules amplifier	23
7.5	Alarms	23
7.6	Combiner and divider	23
7.6.1	Control Unit	23
8	Technical Notes	23
8.1	Microcontroller board Trimmers	23
8.2	Phase Adjustment of RF modules	23
8.3	Splitter board trimmers	23
8.4	Parallel Interface	23
8.5	RF module I/O Interface	23
8.6	Services supply	23
8.7	Emergency CCU Board	23
8.8	PJ10KPS-C Ventilation	23
9	Digital Telemetry (TLC5KPS)	23
9.1	Foreword	23
9.2	Installation	23
9.2.1	Connection	23
9.2.2	Devices settings	23
9.2.3	Installing and configuring the PC software	23
9.2.4	Alarms and commands	23
9.3	Technical details	23
9.3.1	Modules mapping	23
9.3.2	Timings	23
10	Reference view	23

1 Introduction

This manual describes the **PJ10KPS-C**, a solid-state RF amplifier designed for frequency modulation sound broadcasting, manufactured by **R.V.R. Elettronica S.p.A.**. The PJ10KPS-C amplifier constitutes the end power section for FM transmitters fitted with different possible configurations. A control system for the exciters is built into the machine so that in order to have a system with redundant exciters, all that needs to be done is to include two exciters in the transmitter such as, for example, the PTX30LCD exciters made by R.V.R. Elettronica S.p.A.

The configuration of PJ10KPS-C with RVR exciters PTX30-LCD, constitute a complete FM transmitter called TX10KPS

The manual is structured as follows:

- Chapter 1: Presentation of the manual
- Chapter 2: Warranty conditions
- Chapter 3: Safety recommendations
- Chapter 4: Description of the machine and its operating principles
- Chapter 5: Guide for installation and use
- Chapter 6: Most frequent troubleshooting cases on starting up the machine
- Chapter 7: In-depth description of the operation of the modules of the apparatus. This chapter also contains the description of the pin configuration of the connectors and explains how to use the control unit menus, item by item.
- Chapter 8: technical notes.
- Appendix: It contains all the design details (wiring diagrams, assembly plans, etc.) of the PJ10KPS-C.

This manual is written as a general guide for those having previous knowledge and experience with this kind of equipment, well conscious of the risks connected with the operation of electrical equipment.

It is not intended to contain a complete statement of all safety rules which should be observed by personnel in using this or other electronic equipment.

The installation, use and maintenance of this piece of equipment involve risks both for the personnel performing them and for the device itself, that shall be used only by trained personnel.

R.V.R. Elettronica S.p.A. doesn't assume responsibility for injury or damage resulting from improper procedures or practices by untrained/unqualified personnel in the handling of this unit.

Please observe all local codes and fire protection standards in the operations of this unit.

WARNING: always disconnect power before opening covers or removing any part of this unit. Use appropriate grounding procedures to short out capacitors and high voltage points before servicing.

WARNING: this device can irradiate radio frequency waves, and if it's not installed following the instructions contained in the manual and local regulations it could generate interferences in radio communications.

This is a "CLASS A" equipment. In a residential place this equipment can cause hash. In this case can be requested to user to take the necessary measures.

R.V.R. Elettronica S.p.A. reserves the right to modify the design and/or the technical specifications of the product and this manual without notice.

2 Warranty

Any product of **R.V.R. Elettronica** is covered by a 24 (twenty four) month warranty.

For components like tubes for power amplifiers, the original manufacturer's warranty applies.

R.V.R. Elettronica S.p.A. extends to the original end-user purchaser all manufacturers warranties which are transferable and all claims are to be made directly to R.V.R. per indicated procedures.

Warranty shall not include:

- 1 You damn that are verified each other during the consignment of the machine to the R.V.R. for possible reparations;
- 2 Any unauthorized repair/modification;
- 3 Incidental/consequential damages as a result of any defect
- 4 Nominal non-incidentals defects
- 5 Re-shipment costs or insurance of the unit or replacement units/parts

Any damage to the goods must be reported to the carrier in writing on the shipment receipt.

Any discrepancy or damage discovered subsequent to delivery, shall be reported to **R.V.R. Elettronica** within **5** (five) days from delivery date.

To claim your rights under this warranty, you should follow this procedure:

- 1 Contact the dealer or distributor where you purchased the unit. Describe the problem and, so that a possible easy solution can be detected.
- 2 Dealers and Distributors are supplied with all the information about problems that may occur and usually they can repair the unit quicker than what the manufacturer could do. Very often installing errors are discovered by dealers.
- 3 If your dealer cannot help you, contact R.V.R. Elettronica and explain the problem. If it is decided to return the unit to the factory, R.V.R. Elettronica will mail you a regular authorization with all the necessary instructions to send back the goods.
- 4 When you receive the authorization, you can return the unit. Pack it carefully for the shipment, preferably using the original packing and seal the package perfectly. The customer always assumes the risks of loss (i.e., R.V.R. is never responsible for damage or loss), until the package reaches R.V.R. premises. For this reason, we suggest you to insure the goods for the whole value. Shipment must be effected C.I.F. (PREPAID) to the address specified by R.V.R.'s service manager on the authorization
- 5 **DO NOT RETURN UNITS WITHOUT OUR AUTHORIZATION AS THEY WILL BE REFUSED**
- 6 Be sure to enclose a written technical report where mention all the problems found and a copy of your original invoice establishing the starting date of the warranty.

Replacement and warranty parts may be ordered from the following address. Be sure to include the equipment model and serial number as well as part description and part number.

R.V.R. Elettronica S.p.A.
Via del Fonditore, 2/2c
40138 BOLOGNA
ITALY
Tel. +39 051 6010506

3 First Aid

The personnel employed in the installation, use and maintenance of the device, shall be familiar with theory and practice of first aid..

3.1 Treatment of electrical shocks

3.1.1 If the victim is not responsive

Follow the A-B-C's of basic life support

- Place victim flat on his back on a hard surface.
- Open airway: lift up neck, push forehead back (Fig. 3-1).
- clear out mouth if necessary and observe for breathing
- if not breathing, begin artificial breathing (Figure 3-2): tilt head, pinch nostrils, make airtight seal, four quick full breaths. Remember mouth to mouth resuscitation must be commenced as soon as possible



Figure 3-1



Figure 3-2

- Check carotid pulse (Fig 3-3); if pulse is absent, begin artificial circulation (Fig. 3-4) depressing sternum (Fig. 3-5)



Figure 3-3

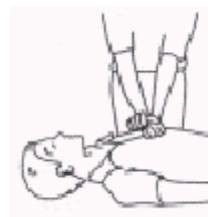


Figure 3-4

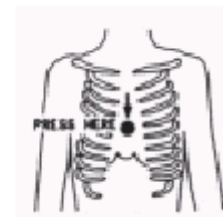


Figure 3-5

- In case of only one rescuer, 15 compressions alternated to two breaths.
- If there are two rescuers, the rhythm shall be of one breath each 5 compressions.
- Do not interrupt the rhythm of compressions when the second person is giving breath.
- Call for medical assistance as soon as possible.

3.1.2 If victim is responsive

- Keep them warm
- Keep them as quiet as possible
- Loosen their clothing (a reclining position is recommended)

- Call for medical help as soon as possible

3.2 Treatment of electrical Burns

3.2.1 Extensive burned and broken skin

- Cover area with clean sheet or cloth
- Do not break blisters, remove tissue, remove adhered particles of clothing, or apply any salve or ointment.
- Treat victim for shock as required.
- Arrange transportation to a hospital as quickly as possible.
- If arms or legs are affected keep them elevated

If medical help will not be available within an hour and the victim is conscious and not vomiting, give him a weak solution of salt and soda: 1 level teaspoonful of salt and 1/2 level teaspoonful of baking soda to each quart of water (neither hot or cold). Allow victim to sip slowly about 4 ounces (half a glass) over a period of 15 minutes. Discontinue fluid if vomiting occurs

DO NOT give alcohol

3.2.2 Less severe burns

- Apply cool (not ice cold) compresses using the cleansed available cloth article.
- Do not break blisters, remove tissue, remove adhered particles of clothing, or apply salve or ointment.
- Apply clean dry dressing if necessary.
- Treat victim for shock as required.
- Arrange transportation to a hospital as quickly as possible
- If arms or legs are affected keep them elevated.

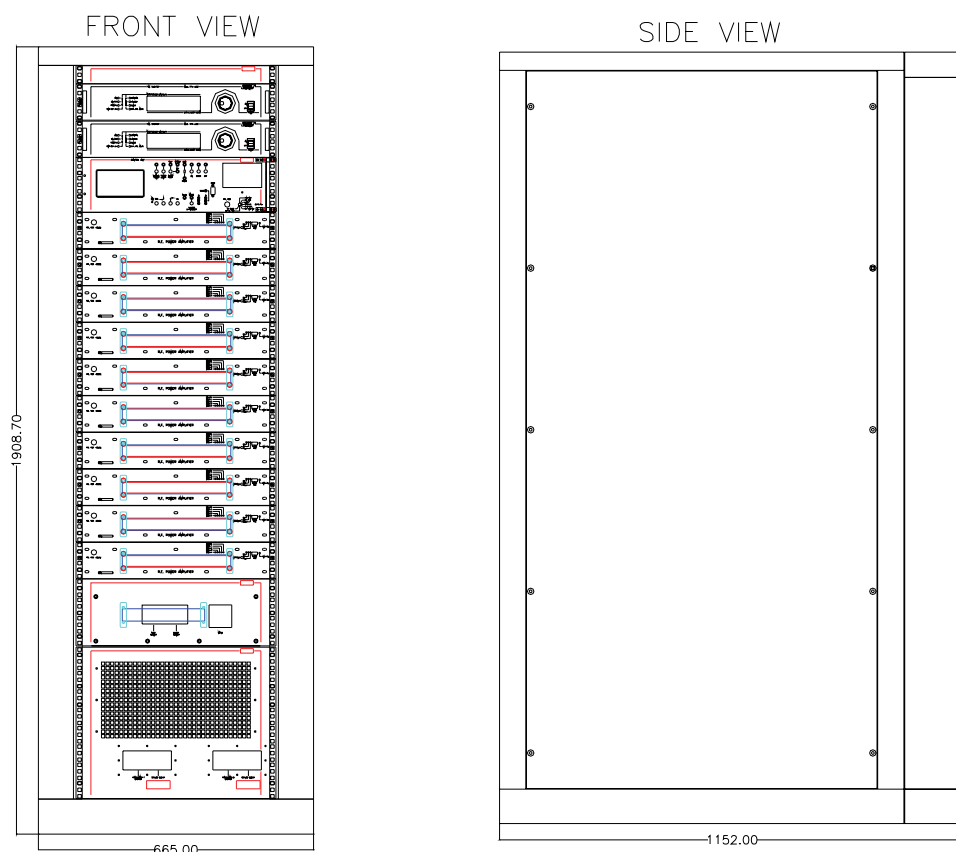
4 General Description

The PJ10KPS-C is a RF amplifier for frequency modulation sound broadcasting. It is a fully solid-state apparatus of modern design that uses MOSFET as active components in the FM amplifying modules. This chapter briefly describes the machine's main features.

4.1 Composition

The PJ10KPS-C amplifier is made up of modules inserted in a 19" rack. The main modules are as follows:

- 1 Control unit
- 10 x 1.2 kW RF amplifier modules
- 1 Control unit
- 2 Power supply unit carriages
- 1 Splitter/Input RF



The amplifier is supplied complete with all its parts, not really "modules", essential for its operation such as the fans for dissipating the heat generated by the machine inside the room and all the accessories for the electrical and RF wiring. As a rule, the amplifier is supplied as a complete transmitter therefore the two FM exciters that it manages will be provided and connected (a service exciter and a spare exciter).

4.2 Technical specifications

Frequency range:	87.5 to 108.0 MHz
Nominal RF power:	10,000 W
Power supply voltage:	400 Three-phase, 3F+N
Exciting power:	Max. 30 W
Consumption:	19 kW Typical
Power factor:	> 0.95
Weight:	500 kg (rack) – 19 kg (module) – 140 kg (Power supply)

Additional important features of the PJ10KPS-C are as follows:

- The 1.2 kW amplifying modules are implemented by means of plug-in technology: the individual modules may be removed for performing maintenance operations, for instance, without having to turn off the transmitter. The transmitter keeps working at reduced power even if the module has been removed. This operation may be carried out without any risk of damaging the module itself, or the amplifier as a whole, thanks to the control system and to the RF connectors, the power supply and the purposely designed data-exchange. For further information refer to the maintenance section.
- Each module is controlled by a microprocessor-based card that checks and adjusts its operating mode. The resulting data are transmitted to the control unit.
- The control unit manages the changeover of the two exciters both in automatic and manual mode.
- The amplifier may be equipped with a dual power supply/rectifier module. Both modules operate in this case the configuration is in “hot stand-by” since both supply, when operating under normal conditions, half of the current required by the machine to work. When one module is absent or faulty, the module that is present supplies all the required current by itself. The sufficient dimensioning of each power supply unit guarantees that the machine will work efficiently at its nominal power level.
- The amplifier can work as usual even if the control unit is not present. In fact, the control unit may be substituted temporarily with an electromechanical interface by means of which the user may give the ON and OFF commands to the machine. However, in this case all the numeric type information will be missing and the power level remains the last one enabled before removing the control unit.

4.3 Options

The PJ10KPS-C envisages the following options:

- Single or dual exciter
- N+1 configuration
- Different kinds of exciters
- Automatic restore after safety tripping or manual restore

4.4 Operating principles

This description is based on the block diagram shown in Figure 4-1.

The PJ10KPS-C amplifier essentially comprises three blocks:

- The power supply section
- The Splitter-Coupler section
- The RF amplifier section

The power supply section of the PJ10KPS-C amplifier is made up of one or two three-phase transformers, each one associated with a rectifier circuit for generating the non-stabilized voltage of 80V that supplies the RF modules. The transformers and the rectifier circuits are mounted on removable carriages together with power inductors that help achieve a power factor of about 94%.

The power supply unit carriage is dimensioned for supplying all the power required for the PJ10KPS-C to operate at full power. Therefore the configuration of the machine with two power supply unit carriages is a hot stand-by redundant one.

The power supply section is controlled by a microprocessor-based card installed in the rack.

The Splitter-Coupler section performs all the treatment of the RF signal except for the power amplification.

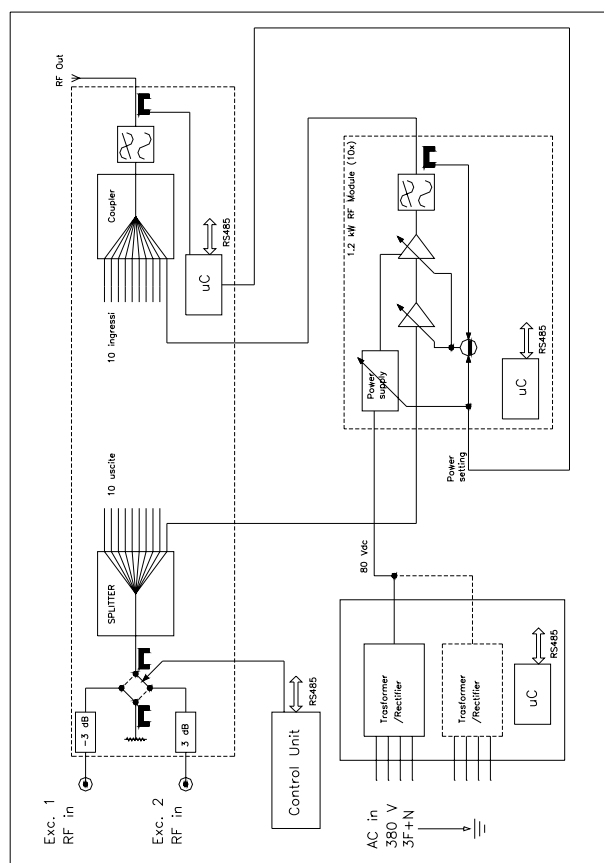


Figure 4-1 Block diagram of the PJ10KPS

The RF signals generated by two exciters (in the redundant configuration) are first attenuated by 3 dB to improve the uncoupling among the stages and then connected to a coaxial relay commanded by the control unit. One of the two signals is closed on a dummy load built into the machine whereas the other signal is connected to the input splitter. The power of both signals is measured by specific directional couplers.

The RF signal of the selected exciter is divided into ten branches, each of which is passed to the input of an amplifying module.

The ten RF amplifiers branches are recombined by the coupler at the output of the amplifying modules. The overall amplified RF signal is filtered by a low-pass filter for eliminating the harmonics and is therefore available at the output connector.

The Splitter-Coupler section is controlled by a microprocessor-based card, which makes the values detected at the various measuring points available for the user and for the diagnostics functions.

The machine contains 10 R.F. amplifier modules each of which is capable of supplying a maximum of 1.2 kW RF. Each module includes a switching mode power supply unit that regulates and stabilizes the power supply voltage supplied by the power supply section.

Each amplifying module contains a ten stage with gain that varies according to the MOSFET BLF175. The RF signal amplified by the driver is then separated into four branches, amplified by four modules based on BLF 278, recombined and filtered by a low-pass filter.

Each RF amplifying module is controlled by a microprocessor-based card, connected to the other microprocessor-based cards of the machine by means of a RS485 type bus.

Each module runs the Automatic Power Control function for regulating the supplied power: the gain of the amplifying stages and the voltage supplied by the switching power supply unit are regulated so that the power that is output from the module corresponds, if possible, to the set level.

The overall power that the PJ10KPS-C must supply is controlled by the microprocessor-based card of the splitter-combiner section according to the settings made on the control unit for the NOMINAL POWER and LOWER POWER parameters.

5 Installation and use

This chapter contains the basic instructions for installing and using the PJ10KPS-C amplifier. If necessary, more in-depth information about the operating principles may be traced in the next chapters.

5.1 Assembly

For practical reasons and for transport safety, the machine is usually supplied disassembled to the customer. The assembly procedure is rather simple and can be carried out by any qualified technician.

Caution: In order to avoid the risk of damaging the machine and/or of injuring the operators, it is advisable to closely adhere to the instructions provided below. Always respect all the safety regulations and standards in force.

Identify the machine components:

- The rack (various components are assembled, such as the coupler, the splitter, the control unit, the main blower) [Figure 5-1 a)]
- The 10 RF modules [Figure 5-1 b)]
- One or two transformer/rectifier carriages [Figure 5-1 c)]
- The exciters [Figure 5-1 d)]. (As a rule the amplifier is supplied as a complete transmitter. This example shows two PTXLCD exciters produced by R.V.R. Elettronica. Usually the exciters are pre-assembled inside the rack).

Check that all the components are in perfect working order. Should there be any kind of problem, for instance if there is any damage caused by the transport of the components, read the instructions associated with the Warranty at the beginning of this manual (chapter 2).

- 1 Install the rack in the location where the transmitter will work. The rack is mounted on wheels for simplifying its movement, therefore after having positioned it where expected, it is advisable to use the four screws at the bottom of the rack to steady it perpendicular to the ground.

The transmitter is cooled by forced ventilation. The air outlet is on the machine's roof whereas in the standard configuration the air intake is envisaged at the back of the machine. If you opt for this solution, install the machine at least 50 cm. away from the back wall, so that air can flow under optimal conditions. The air inlet may also be delivered from the machine's roof, by removing the cover from the hole that is pre-cut in the roof for this purpose.

- 2
 - A. Remove panels the power supply unit carriages from the rack. Also remove the stop bar of the power supply unit carriages that is at the bottom of the rack.
 - B. Climb on the chest back filter air with special grapevines and zippers.

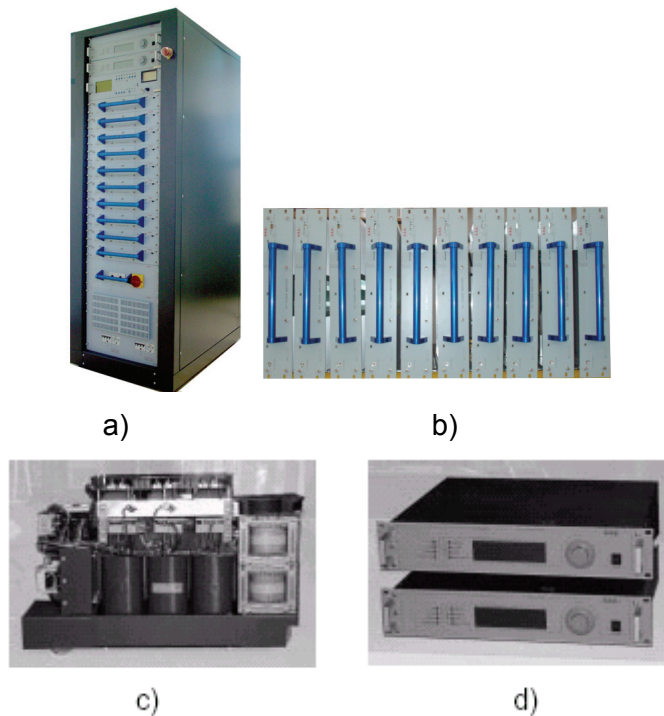


Figure 5-1 Components of the PJ10KPS-C

- 3 **Insert the first amplifying module into the RF modules compartment [Figure 5-2].**



Figure 5-2 Inserting a RF module

Slide the module until the two fixing screws fit into their seats. Then tighten the fixing screws at the same time so that the module inserts into its compartment remaining parallel until it is perfectly in place.

- 4 Repeat the operation with the other nine RF modules.
- 5 Insert the first transformer carriage into the left-hand side of the specific compartment. The carriage is mounted on three wheels (two are fixed on the front side and one pivoting rear wheel) to facilitate this operation. Move the carriage toward the left-hand

wall of the rack [Figure 5-3] and then move it forward until the connectors at the back are perfectly inserted into their seats.

The power supply unit carriage is very heavy and its barycentre is high, therefore be careful when handling it to avoid tipping it over.

- 6 If you have a redundant power supply unit, insert the second power supply unit carriage as you did with the first one.
- 7 Position the stop bar of the power supply unit carriages.
- 8 Make the necessary connections of the power supply unit carriages:
 - Power supply connector [Figure 5-4 a)]
 - Data connectors [Figure 5-4 b)]
- 9 Connect the machine's main power supply cable. Route the cable (5-pole type) through the raceway on the machine's roof [Figure 5-5 a)] and fix the conductors to the terminals of the master switch [Figure 5-5 b)]. The last operation is usually performed by removing the knob and the cover of the isolating switch.

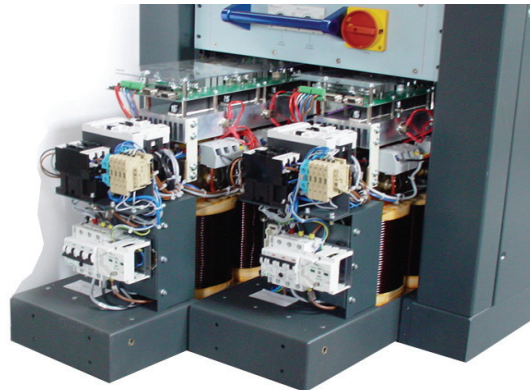


Figure 5-3 Power supply carriage connectors

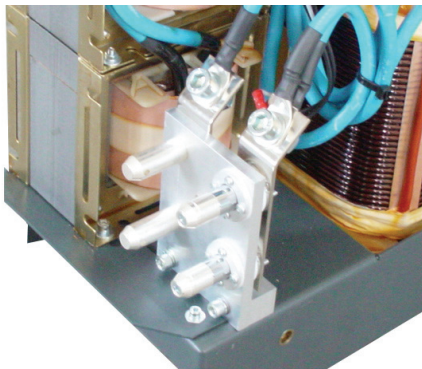


Figure 5-3A Power supply male connectors

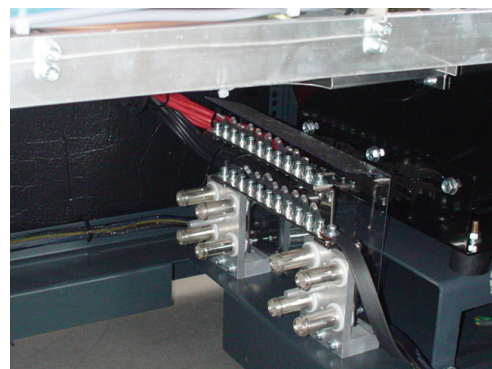


Figure 5-3B Power supply female connectors

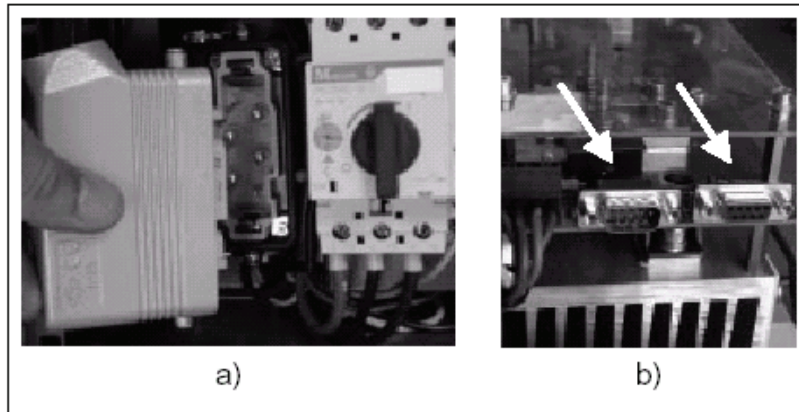
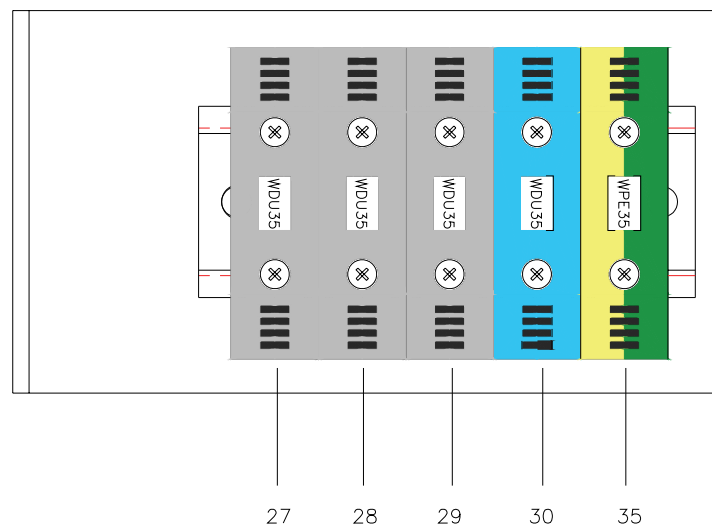


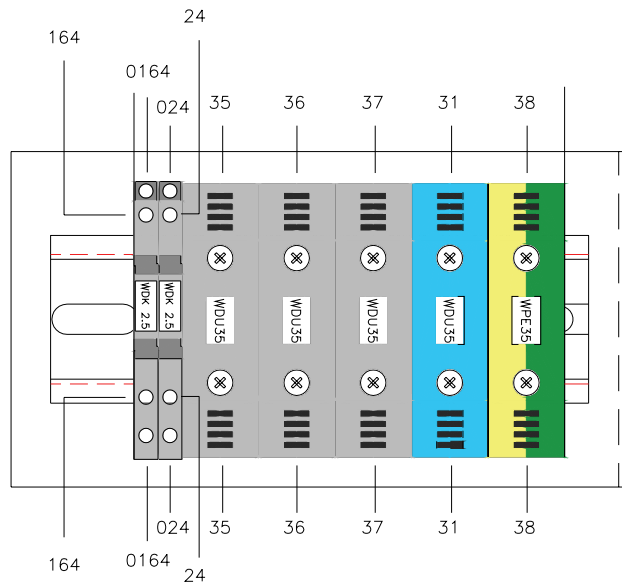
Figure 5-4 Power supply carriage connectors



Figure 5-5 Power supply cable



External view (Power supply cable)



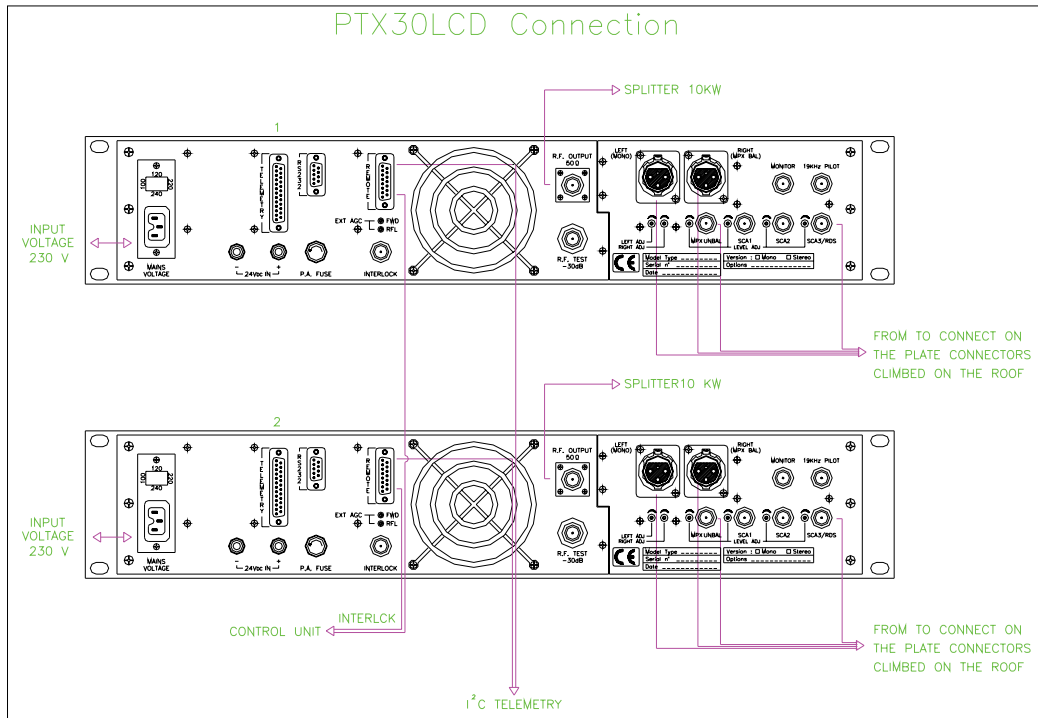
Internal view (Power supply cable)

Caution: The connection of the machine to the electric alimentation is performed fixing to a 5 poles cable with bare terminals to a terminal block. Making sure without any possibility of error that the cable is not under tension while working on it.

It is recommended not to turn on the machine without first have connected the RF exit to the antenna or to the dummy load!

The PJ10KPS-C requires a three power supply 3F (black, brown and grey) + N (blue) + GND (green yellow) able to give 50A for phase. Keep this requirement in mind in connecting to the personal distribution board.

- 10 Reposition the protection panels of the RF modules and of the transformer/rectifier carriages.
- 11 If the PJ10KPS-C was not supplied complete with pre-assembled exciters, insert and connect the exciters into the appropriate housings. The connecting cables for the exciters are already inside the rack, namely:
 - Right/MPX bal. audio connection (XLR connector)
 - Left/Mono audio connection (XLR connector)
 - MPX unbal. audio connection (BNC connector)
 - Power supply (VDE connector)
 - Control connector (DB15 connector)



Now you may perform the preliminary checks on the amplifier and start it up.

The connectors on the roof of the machine are not in parallel but directly connect to the exciters (L and R exciter 1, L and R exciter 2 etc). Keep this in mind to make the audio connections, that in some cases can require, for example, the use of an audio distributor.

5.1.1 Configuration of the alimention of the PJ10KPS-C

The PJ10KPS-C alimention configuration can be 360V, 380V and 415V to triangle or 208V, 220V and 240V in that to star.

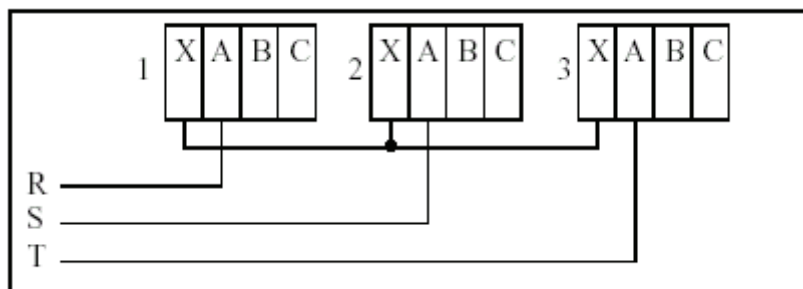
To configure the amplifier for the two types of alimention, is necessary to act on the followings parts:

1 The primary three phase transformer

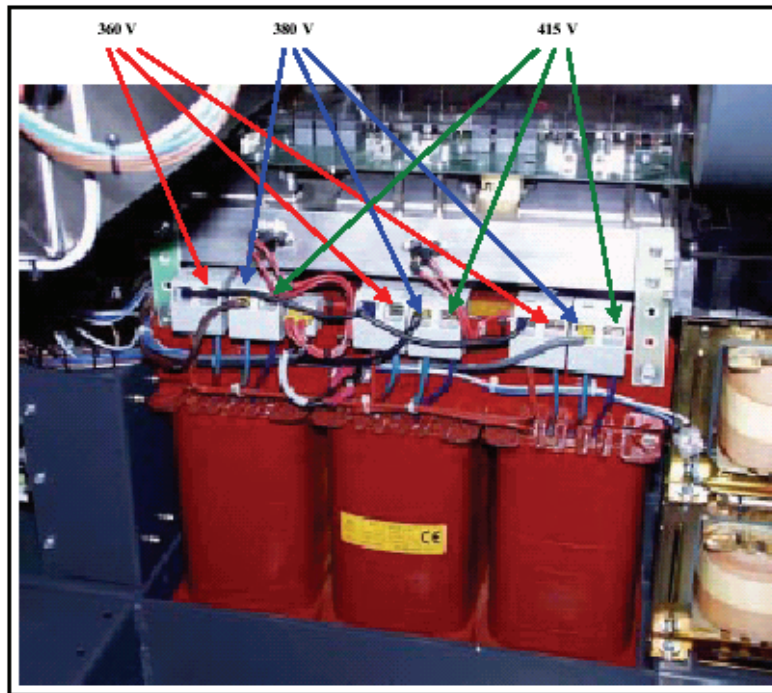
For the configuration of the alimention to 360V, 380V and 415V, connect the clamps "X" together of the primary threephase transformer.

The phases R, S and T they will go, therefore, connected to the clamps:

- A. to have 360V
- B. to have 380V
- C. to have 415V



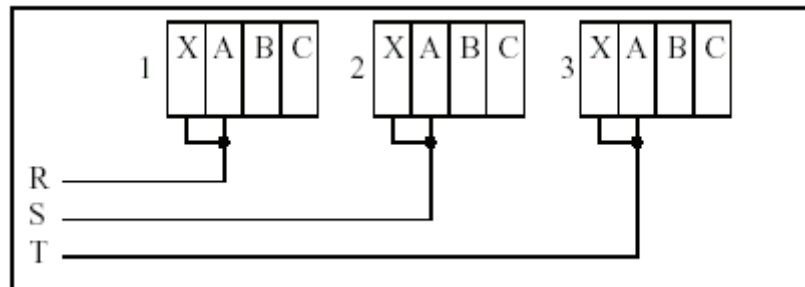
The photo shows the configuration of the terminals to get the different alimentations.



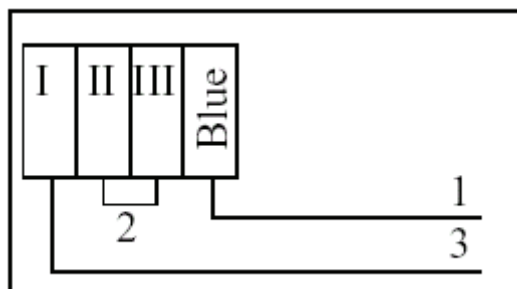
For the configuration of the alimentation to 208V, 220V and 240V, connect the clamps “X” together with the respective phase R, S and T.

The phases R, S and T they will go, therefore, connected to the clamps:

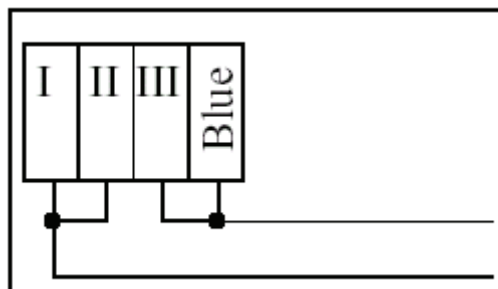
- A. to have 208V
- B. to have 220V
- C. to have 220V



2 Clamp of the service transformer

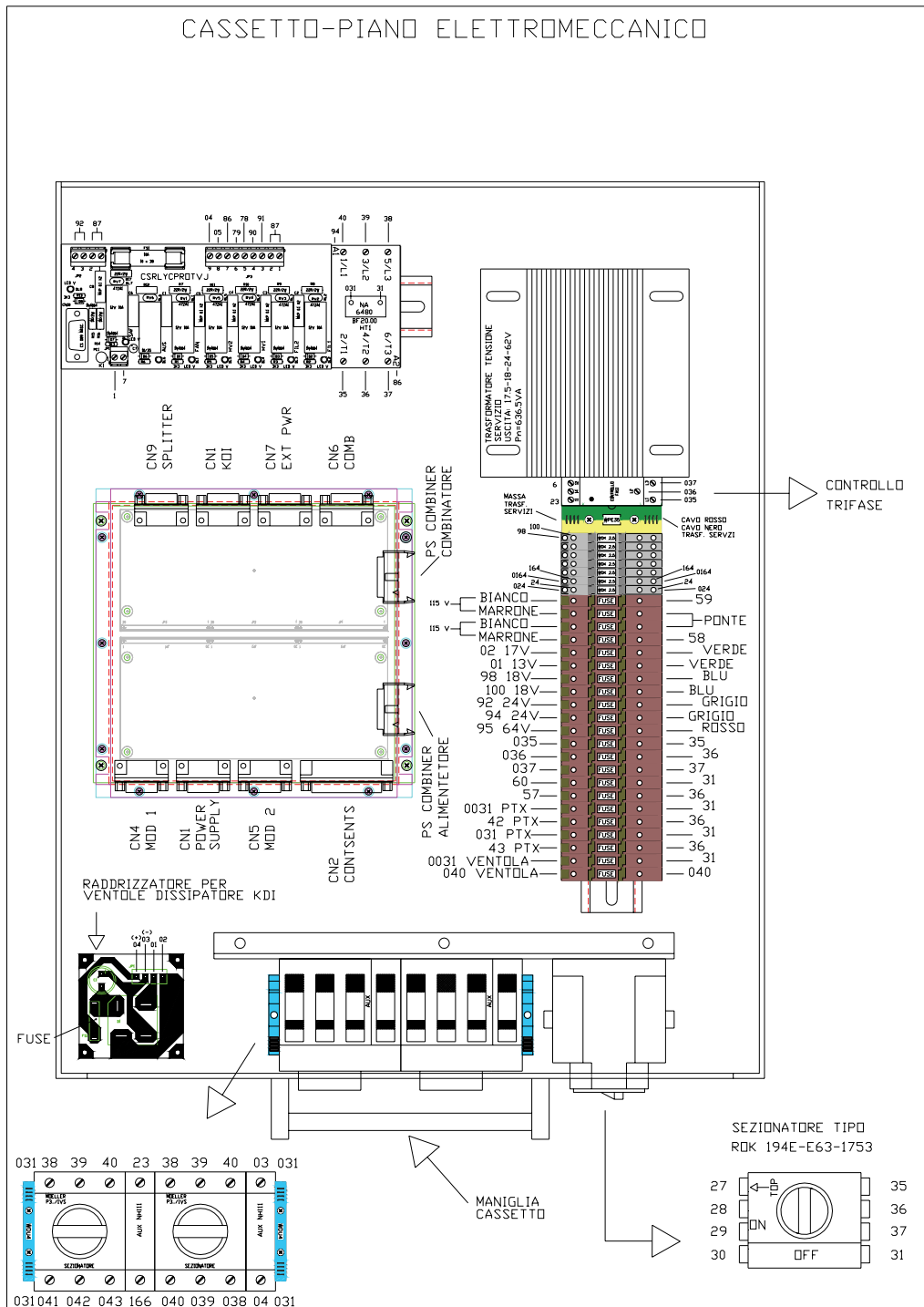


If the PJ10KPS-C is fed to a tension of 360V, 380V and 415V threephase, the clamps of the service transformer have connected with the series coils.



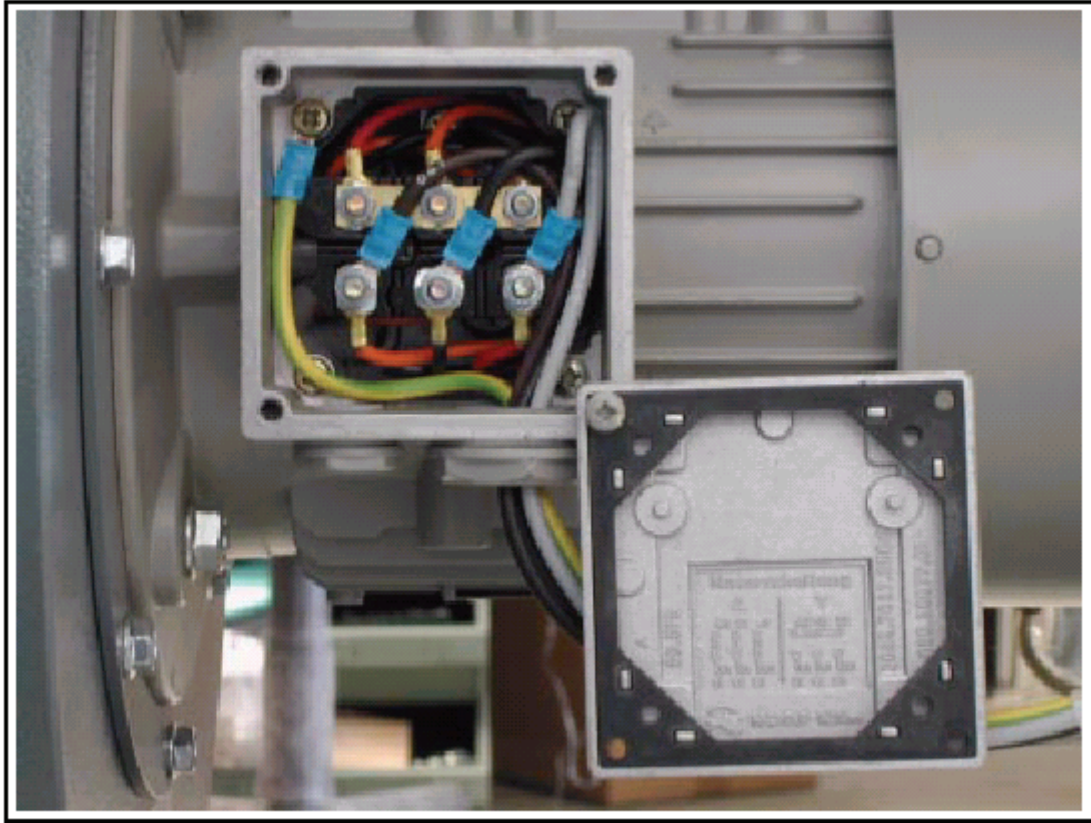
If the PJ10KPS-C is fed to a tension of 208V, 220V and 240V threephase, the clamps of the service transformer have connected with the parallel coils.





3 Primary blower

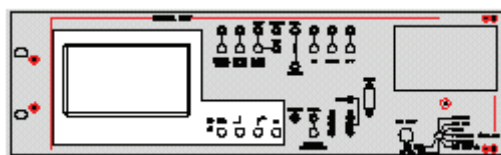
For the configuration open the cover of the fan.



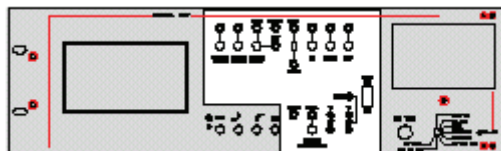
5.2 Amplifier check

The operator controls and checks the status of the PJ10KPS-C by means of the control unit. Three control groups are present on this unit:

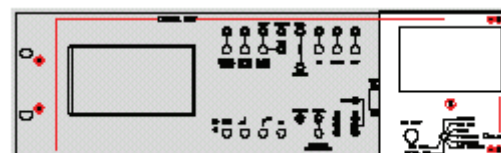
- LCD and scroll buttons



- Buttons, selector switches and LEDs



- Analogue instrument and rotary selector switch



```

Overall Status:          Timer (23-05)
Control Unit.....On-Exct.1
Power Supply.....On
R.F. Combiner...On
R.F. Unit-1.....On
R.F. Unit-2.....On
R.F. Unit-3.....On
R.F. Unit-4.....On
R.F. Unit-5.....On
R.F. Unit-6.....On
R.F. Unit-7.....On
R.F. Unit-8.....On
R.F. Unit-9.....On
R.F. Unit-10....On

Press <Esc> for Menu -   Hours: 00015
    
```

Figure 5-6 Default screenful



```

***** Menu Select *****
Control Unit
Power Supply
R.F. Combiner
R.F. Units
Alarms
Service
Settings
Exciters
Info
Release
    
```

Figure 5-7 Menu select screenful

5.2.1 LCD Display

The operator uses the control software of the transmitter by means of a series of menus that are displayed on the LCD. Four specific keys are provided for scrolling through the menus, performing the settings and giving the commands:

Function	Description
OK	Click this button to access a sub-menu, to enter the editing mode or to confirm a modified value.
ESC	Click this button to exit from a menu or to cancel the modification of a value.
	Click this button to scroll inside a menu (to the right or down) or to reduce the value of a parameter being modified.
	Click this button to scroll inside a menu (to the left or up) or to increase the value of a parameter being modified.

When the operator is not using the various buttons to navigate, the LCD displays the preset screenful that shows the overall status of the machine's modules (Figure 5-6). The control unit acquires, every second, the status of the other modules by means of an RS485 serial bus. The activity at the bus is signalled by the "BUS INT" LEDs on the unit's panel.

As indicated on the preset screenful, push the ESC button to access the screenful for selecting the menus (Figure 5-7).

On reaching the selection screenful, move the cursor (full rectangle) using the arrow keys to display the concerned line. Then click OK to access the associated menu. Select the "General Status" menu to return to the preset screenful.

5.2.2 Buttons, selector switches and LEDs

The typical machine-control operations are performed using the buttons of the control unit's panel. Specific LEDs correspond to each button and selector switch for indicating the machine's status.

The functions performed by the controls are as follows:

Function	Description
OFF	Button for turning off the machine. A LED signals that the machine is OFF. In this status, the exciters and the fan are off and the RF amplifying modules are not powered.
STDBY	Button for setting the machine in standby. In this status the transmitter does not emit any power, but is ready to start the transmission: the main blower is on, the RF modules are not powered, the exciters are on but locked by means of an interlock. The stand-by is used to test the exciters, in fact in manual modality the operator could arrange them in base to the own requirements; coming from an "On" in manual modality, the system does not touch the interlock. Stand-by status is signalled from a LED. In manual and in stand-by the inhibit of the device doesn't intervene on the interlock of the exciters. This could necessary when the apparatus is in configuration n+1 for verify if the exciters are operational.
ON	Button for turning on the transmitter. The RF power supply is activated.
LOC/REM	Selector switch for setting the transmitter in remote or local mode. In local mode the buttons and the controls via the menus are active. In remote mode the buttons and the controls via the menus are inhibited and the commands may be given only remotely via the parallel interface or via the remote control software.
ALARM RESET	Button for zeroing the FAULT or WARNING alarms.
NOMINAL POWER	Click this button to set the transmitter for supplying the nominal power level. A specific LED signals this setting. The value that corresponds to the nominal level is set by the operator using the menu settings in Section 7.1.8.
POWER LOWER	Click this button to set the transmitter for supplying the reduced power level. A specific LED signals this set-ting. The value that corresponds to the reduced level is set by the operator using the menus.
EXCITER CHANGEOVER	Use this button to set the changeover system in manual or automatic mode. The signaling LED turns on when the manual mode is selected. On performing a changeover, the exciter connected to the amplifier is deviated toward the internal dummy load and vice-versa. The operator must use the exciters menu to perform the changeover in manual mode.
LEDs (Wait, Warning, Fault)	Other signaling LEDs are connected to the alarm states and to the serial data transmissions that take place among the microprocessorbased cards. The function of these LEDs is described further on in this manual.

5.2.3 Analogue instruments

The control unit of PJ10KPS-C contains an analog meter with a rotating selector that are useful for an immediate display of the following parameters:

FWD PWR	Transmitter direct power
RFL PWR	Transmitter reflected power
UNBAL	Transmitter unbalancing power
PWR EXC1	Power supplied by the exciter currently connected to the amplifier. This value is measured by the machine in the splitter section
PWR EXC2	Power supplied by the exciter currently connected to the internal load. This value is measured by the amplifier in the splitter section
EXT FWD PWR	Direct power of an external combiner.
EXT RFL FWD	Reflected power of an external combiner.
EXT UNBAL	Unbalancing power of an external combiner. These three values are used when the transmitter is connected to a 1+1 system. The SET outputs may also be connected to these quantities.

5.3 First start

This section describes the procedure for powering-on the machine the first time.

For simplicity's sake, the automatic control capacities of the exciters are temporarily disabled.

Refer to chapter 5.4 that provides the instructions for turning on the PJ10KPS-C in the various cases.

5.3.1 Preliminary operation

Before activating this piece of equipment, the necessary connections must be performed, and in particular:

- Power supply
- Modulating signals (Audio or MPX, RDS...)
- RF load (antenna feeder or dummy load)

About to the connections of the power supply and the modulating signals, please refer to chapter 5.1.

The machine's RF output is the "EIA 1 5/8" flanged type and is accessed on the roof of the PJ10KPS-C. If a dummy load capable of dissipating the RF power generated by the transmitter is available, it is advisable to run the first tests by connecting to it rather than to the transmission antenna.

5.3.2 Power-on

When powering-on the transmitter the first time, perform the operations outlined in the table below.

The "Result" column indicates the immediate results of the operations performed plus a few indications that confirm that the machine is working efficiently.

Should any inconsistencies occur as compared to these indications, interrupt the procedure

and identify the reason for the malfunction before resuming the procedure.

Operation	Result
Close the "Transformer Breaker" isolating switches	The power supply unit carriages are powered
Turn the "Mains" switch	The whole transmitter is powered. The machine is activated in the same status it was in when it was turned off the last time
Press the OFF key of the control unit	RF emission by the transmitter is inhibited; the exciters are off; the RF amplifier modules are off
Press the EXCITER CHANGEOVER key of the control unit	The automatic management for the exciters changeover is disabled. The MANUAL LED must be on (otherwise press the key again)
Press the STDBY key of the control unit	The exciters are turned on in interlock status. The RF amplifying modules stay disabled. Being in manual modality, the exciters could be unlocked to verify the operation (see 5.3.3).
Set the parameters of the control unit	This procedure is described in chapter 5.3.3 on in this manual. The control unit communicates the nominal power and reduced power values to the RF modules. It also handles the coaxial relays so that the on air exciter is the desired one and sets the exciter to ON mode
Set the exciters	Adhere to the instructions of the exciters used for setting the required work frequency on the exciters. Regulate the output power of the exciters to 20 W.
Press POWER LOWER and ON	The current exciter is activated (the interlock is released from the exciter) and its power emission is enabled. The power emitted by the PJ10KPS-C amplifier increases gradually until it attains the level that had been set previously as "Reduced power". Check the emitted power level by means of the analog instrument with the selector switched to FWD PWR position
Press NOMINAL POWER	Power supplied by PJ10KPS-C increases and attains the set nominal value. Check it on the analog instrument.
When the transmitter is on and works at its nominal power, the whole series of "accessory" checks and settings deemed necessary may be carried out before starting up the apparatus.	

5.3.3 Control unit settings

The settings of the control unit that are required for starting up the machine, mentioned in the powering-on procedure, are the following:

- 1 Setting of the power levels
- 2 Setting of the on air exciter

```

MENU: Settings:
Nominal Pwr.....100% - (10 kw)
Low Power.....50% - (5.00 kw)

Set Assign Limit
SET1 Ch - 1 80 % - (8.00 kw)
SET1 Ch - 1 50 % - (5.00 kw)
SET1 Ch - 2 20 % - (440 W)
SET1 Ch - 1 50 % - (5.00 W)

Exc s wait time: 10 sec.
Talk Address 4
Time (h-n) 14-49
Date (d-n-y) 12-02-02

Write Config. All
    
```

Figura 5-8 Menu' Settings

Before performing the first operation, click the ESC button. The display shows the screenful for selecting the menus [Figure 5-7]. Click the arrow keys until the cursor highlights the line associated with the Setting menu. Click OK: the software will show the associated screenful on the display [Figure 5-8].

On having accessed the Settings menu, use the arrow keys to select the nominal power line (Pwr. Out) and click OK. Use the arrow keys to decrease or increase the indicated percentage value up to the required level. Click OK again to set this value. Repeat the operation for the line associated with the reduced power level (Pwr. Lower).

The new power level is transmitted to the combiner module and then stored in EEPROM only when the ESC button is clicked.

When inside this menu, it is advisable to check the date and time lines and update them if necessary. Note: the date and time are used only for marking the events in the alarms register.

The date and time do not need to be updated in the transmitter in order for it to work efficiently.

On having completed these settings, click ESC to return to the selection screenful.

In order to set the on air exciter, select the Exciters menu [Figure 5-9]. Take into consideration the On Air Exciter line: the number to the right indicates the exciter being used. To change it simply highlight the line and click OK.

```

Menu: Exciters

Main Exc..... 22 W
Stby Exc..... 8 W

Main Exciter: 1 | Push <OK>
Exc.1 On | to change
Exc.2 Off |

Exciter s Mains: On.
    
```

Figure 5-9 Exciters Menu

The exchange of the exciters is assisted from the software, that is when the commutation is carried out, the interlock comes systematized in the correct way independently from like they were. The interlock could be modified also manually in case of necessity.

5.4 Management of the exciters

The control unit can perform the automatic changeover between exciters if one malfunctions. The Manual LED on the panel indicates, when it is lighted up, that the automatic changeover function is disabled. In order to enable it, click the EXCITER CHANGEOVER button and check that the LED turns off. In operation of the PJ10KPS-C automatism state, the behavior of the machine will be different. In this chapter are described the different cases.

In function of the state of the PJ10KPS-C automatism, the behaviour of the machine will be various. In this chapter are described the different cases.

5.4.1 Start-up from power-on with exciters in manual mode

When powering on the machine with the exciters in manual mode, the apparatus does not perform any check, both mute RF signals are active and the changeover relay remains in standby status. Use the exciters menu to activate an exciter.

This is why, if the transmitter is left in manual mode, any momentary power failure will cause the transmitter to be inactive when turned on again. Therefore it is advisable to leave the PJ10KPS-C in automatic mode when you are not performing maintenance operations.

5.4.2 From OFF to ON with exciters in manual

When switching from OFF (or STDBY) to ON with the exciters in manual mode, the apparatus does not perform any check and the exciter that is currently set to on air is the one that is aired.

If the mains signal is not OK, the exciters turn off automatically.

If the maximum drive power is exceeded during operations ($> 35W$), the PJ10KPS-C is set to fault status and power supply is cut to the exciters. A message in the alarms menu signals this fault.

When the apparatus is set to STDBY, the mute RF signals of the exciters are not activated and may be modified by the operator.

When the apparatus is set to EXT INT or AUX INT, the mute RF signals of the exciters are not activated and may be modified by the operator.

5.4.3 Automatic changeover

When the PJ10KPS-C is in the exciter automatic changeover mode, the power emitted by the on air exciter is checked constantly. If at any time the on air exciter is no longer good (i.e. power drops to below the preset level), the apparatus is kept operational whereas the exciter connected to the internal Dummy Load turns on. If the latter one is good (i.e. it is capable of supplying the required power), then the two exciters are changed over. Instead if the alternative exciter is not good, no changeover takes place, the control unit commands the mute RF of the exciter to Dummy Load, it waits 120 s. and repeats the attempt. This procedure is repeated indefinitely until one of the two exciters is considered to be good.

During the whole length of time during which there is no good exciter, the PJ10KPS-C keeps the WAIT LED on for signalling this status.

Each exciter is fitted with its own mute RF. On being commanded, the piloting signal must return to zero within 3 seconds at the most. If this does not occur, the fault is recorded by an error message that is entered in the alarms menu.

If the mains signal is not OK, the exciters turn off automatically. If the piloting power exceeds the limit during operations, the PJ10KPS-C is set to the FAULT status and the power supply of the exciters is turned off. A message in the alarms menu signals the fault. Keep in mind

that the operator's intervention is required to exit from the FAULT status.

If the MAINS signal coming from the bus is not OK, the exciters are all turned off. As soon as the MAINS signal is regular again, the evaluation cycle of the exciters begins (see 5.4.4).

When the apparatus is set to STDBY, the mute RF signals of the exciters are activated and as such both exciters are inhibited. If the ON key is pressed, the system re-evaluates both exciters in the same manner as in the procedure from OFF to ON (see 5.4.4).

When the apparatus is set to EXT INT or AUX INT, the mute RF signals of the exciters are activated and therefore both exciters are inhibited. When the external interlocks are released, the system re-evaluates both exciters as during the phase from OFF to ON (see 5.4.4).

5.4.4 Phase from ON to OFF

When the apparatus is set to OFF status and you press the ON button, the power supply of the exciters is activated and the logic starts to evaluate the exciters. During the evaluation phase, the WAIT LED stays ON.

When the apparatus is turned OFF, it memorizes the exciter on air. Consequently when the machine restarts it can attempt to restore the previous conditions. On the machine restarting, if the exciter that is to be aired does not attain the preset power level whereas the spare one is operational, the apparatus performs the changeover when the evaluation time (120 s.) expires.

On the machine restarting, if both exciters do not attain the preset power level, the apparatus airs the one that had been present when the machine was turned off, after the evaluation time has expired.

5.4.5 Start-up with exciters in automatic mode

The sequence run by the PJ10KPS-C, when the power supply is activated while it is already in ON status and the exciters are in automatic mode, is identical to the one run for switching from OFF to ON. The only difference is that a screenful displays the countdown for determining the fault of the exciters. During this phase the manual/automatic button is inhibited and in order to set the exciters to manual mode you must press the OFF button of the apparatus.

5.4.6 Audio alarm

The control unit of the PJ10KPS-C can manage a fault signal, for each exciter, which normally has an "Audio Alarm" meaning. The control software of the PJ10KPS-C does not intervene in triggering these signals since they must be checked by the exciters (or by any other connected devices).

The Audio Alarm signals are made up of two inputs for the logical signals on the parallel interface and on the "mute RF" command connector of the exciters.

The control unit manages these signals just like it manages the power good signals:

- Each "Audio alarm" signal is associated with its own exciter
- If the audio signal, associated with the exciter that is currently on air, enters an alarm status, the PJ10KPS-C waits for the time configured in the exciter menu before it attempts the restoring operation
- If the audio of the aired exciter is still in alarm status on the elapsing of the aforesaid time interval, the control unit checks if the audio of the exciter on the dummy load is regular. In this case the changeover between the exciters is performed.

Observe the following differences as compared to the case in which power is missing:

- The management of the "Audio alarm" signals is not active during the start-up phase and

during the switching phase from OFF to ON, but only when the exciters are working in automatic.

- In the standard configuration, the aforesaid sequence continues until the audio signal associated with one of the exciters becomes regular again. In the "N+1" configuration, the switching attempt is performed only twice, after which the PJ10KPS-C enters the fault status.
- An Audio Alarm output is provided on the parallel interface: this signal is activated (with no delays) when the audio of the exciter that is currently on air is in alarm status.

5.5 Protection and alarms

The PJ10KPS-C contains a complete protection and alarms system, both at the individual modules level and at the control unit level.

The modules are fitted with a micro-processor-based system that manages any malfunctions locally. The associated information is communicated to the control unit for displaying and storing the events and for the centralized management of the events that require it.

Certain LEDs of the PJ10KPS-C panel are dedicated to the management of the alarms:

LED	Description
WARNING	This LED indicates a warning (something is not correctly working, but the amplifier is still working)
FAULT	This LED indicates a fault (the amplifier is shut off, the operator's intervention is required)
WAIT	This LED indicates the wait status (the amplifier is temporarily off, it will be restarted as soon as the reason that keeps it from working will be removed, or after a fixed amount of time depending on the reason of the intervention of the protection system)

The ALARM RESET button is used for resetting the alarms and restarting the machine.

A complete description of the alarms and protection system is given in chapter 7.5.

6 Troubleshooting

[This chapter will be filled in the next edition of the present manual]

7 Technical description

7.1 Software - Reference guide

This chapter gives a point to point description of the screens composing the software of the PJ10KPS-C.

Since the management software is able to control up to 10 modules, some of the menus configurate themselves for the number of modules. For example, in a PJ10KPS-C the menu Overall Status has ten “RF Unit” lines as in the general example reported in the manual, in the PJ10KPS only ten of them will be shown.

7.1.1 Overall Status menu

This is the default menu appearing when the user switches the unit on.

This menu includes only indications, therefore the user cannot insert any input in its different lines.

Menu Line	Description
Timer	Indication of the start and stop times of the automatic power reduction feature - see “Settings” menu
Control Unit	Status of the control unit (Off or On) and indication of the exciter actually connected to the amplifier (Exct.1 or Exct.2)
Power Supply	Status of the power-supply cart (Off or On)
R.F. Combiner	Status of the RF combiner (Off or On)
R.F. Unit - N	Status of the Rf power amplifier number N (Off or On)
Hours	Timer counting the hours of operation of the transmitter. For example, this indication is useful in order to define when a maintenance operation can be made

From the predefined menu, by pressing the Esc key as indicated on the last line, you can shift to the exchange screen from which you can have access to all the other menus of the unit.

```

Overall Status:           Timer (23-05)
Control Unit....On-Exct.1
Power SUPPLY....On
R.F. Combiner....On
R.F. Unit-1....On
R.F. Unit-2....On
R.F. Unit-3....On
R.F. Unit-4....On
R.F. Unit-5....On
R.F. Unit-6....On
R.F. Unit-7....On
R.F. Unit-8....On
R.F. Unit-9....On
R.F. Unit-10....On
Press <Esc> for Menu -   Hours: 00015
    
```

Figure 7-1 Overall Status menu


```

XXXXXXXXXXXX Menu Select XXXXXXXXXXXXXXX
Control Unit
Power Supply
R.F. Combiner
R.F. Units
Alarms
Service
Settings
Exciters
Info
Release
Modem
    
```

Figure 7-2 Select menu

7.1.2 Select menu

This is the exchange menu from which you can select the different sub-menus that compose the software.

In order to enter a sub-menu, select the correspondent line with the arrow buttons and press Enter.

Menu Line	Description
General Status	General status of the PJ10KPS-C
Power Supply	Status of the power-supply cart
R.F. Combiner	Status of the RF combiner
R.F. Units	Status of the RF power amplifiers
Alarms	Summary of the occurred alarms
Service	Service menu for the switching on/off of the modules
Settings	Setting of the parameters (i.e. Power levels)
Exciters	Parameters of the exciters (i.e. output power, on air exciter)
Info	Information concerning the configuration of the PJ10KPS-C
Release	Information concerning the hardware and software versions of the modules composing the unit
Modem	Settings related to the optional telemetry system (see chap.9)

To return to the predefined menu, select General Status and press OK.

```

Menu: Control Unit
Inputs:
Ext Intl.....Off
Aux Intl.....Off
Exc1 A.Audio..Off
Exc2 A.Audio..Off
L.P.Timer.....Off
Reserve-2.....Off
Reserve-3.....Off
Reserve-4.....Off

Outputs:
Relay Exc.....Off
Exct_1 Mute...Off
Exct_2 Mute...Off
Audio Alarm...Off
Exc s Mains...On

Bus inPut:
Stand_by.....Off

Bus outPut:
Stand_by.....Off

Total Eff.: 80%
    
```

Figure 7-3 Control Unit menu

7.1.3 Control Unit menu

Informative menu on the inputs and the outputs of the control unit of the machine.

Menù line	Description
Ext Intl	Input status “external interlock” (JP4/4 parallel interface)
Aux Intl	Input status “auxiliary interlock” (JP4/5)
Exc1 A.Audio	Input status “audio alarm exciter 1” (JP4/8)
Exc2 A.Audio	Input status “audio alarm exciter 2” (JP4/9)
Reserve 1	Input status “Reserve 1” (JP8/2 parallel interface)
Reserve 2	Input status “Reserve 2” (JP8/3)
Reserve 3	Input status “Reserve 3” (JP8/4)
Reserve 4	Input status “Reserve 4” (JP8/5)
Relay Exc	Exciters exchange relay status (Off = exciter 1 on air)
Exc 1 Mute	Exciter 1 interlock status (Off = RF power enabled)
Exc 2 Mute	Exciter 2 interlock status (Off = RF power enabled)
Audio Alarm	Output Audio Alarm status (JP47/1)
Exc’s Mains	Exciters power supply status (On = power supply enabled)
Stand_by (In)	“Stand by” input line status
Stand_by (Out)	“Stand by” output line status from the control unit
Total Eff	Total efficiency of the machine

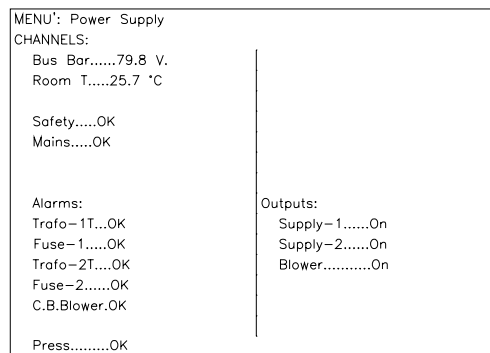


Figura 7-4 Power Supply menu'

7.1.4 Power Supply menu

Information menu showing the status of the Power Supply / Rectifier carriage.

Menù line	Description
Bus Bar	Output voltage from the rectifier on the common 80V dc supply bus.
Room T.	Temperature of the air at the input of the unit
Safety	Status of the safety arrest button. On indicates the functioning is enabled, Off means the unit was arrested through the button
Mains	Status of the main voltage supply. On indicates that the voltage is within the functioning range of the unit and that the phase

	sequence is correct
Trafo-1T	Status of the AC fuses AC low voltage bus bar rectifier and interblock of module 1
Fuse-1	Status of the AC fuses AC low voltage bus bar rectifier and interblock of module 1
Trafo2-2T	Stesso significato di Trafo-1T. Quando il carrello alimentatore/rettificatore 2 non è installato, viene indicato ===.
Fuse-2	Same function as Temp.1. When the supply/rectifier module 2 is not installed, === is indicated
C.B. Blower	Status of the magnetothermal "motor save" interruptor of the circuit breaker blower.
Supply-1	Control contactor of module 1
Supply-2	Control contactor of module 2
Blower	Control contactor of the power of the blower

```

MENU: R.F. COMBINER.
CHANNELS:
COMBINER:
Fwd..... 10000 W
Rfl..... 80 W
Unbal.... 10 W
Rej.LT.. 31.7 °C
Exhaust. 38.8 °C

Var:
S.W.R.... 1.0

External:
Fwd.....=== KW
Rfl.....=== KW
Unbal...=== KW

External:
Main Exc.. 21 W
Stby Exc.. 0 W

Alarms:
Temp.....OK

Outputs:
RF-END.....On
Aux.Fan.....Off
SET1.....On
SET2.....On
SET3.....Off
SET4.....Off
    
```

Figura 7-5 Menù R.F. Combiner

7.1.5 R.F. Combiner menu

This menu contains the information related to the RF part of the complete transmitter. Here the user will find the most interesting parameters, like the overall emitted RF power and the reflected power.

Menu Line	Description
Fwd	Overall emitted RF power of the transmitter
Rfl	Reflected RF power of the transmitter
Unbal	Unbalancement RF power: sum of the power dissipated on the internal resistors due to unbalancement in the RF modules
Rej.IT	Temperature of the load resistors dissipating the unbalancement power
Exhaust	Temperature of the exhaust air (top of the transmitter)
S.W.R.	Standing Wave Ratio, calculated by the Control Unit on the basis of the measured forward and reflected power
(External) Fwd	Forward power of an external transmitter (when configured for this function)

(External) Rfl	Reflected power of an external transmitter (when configured for this function)
(External) Unbal	Unbalancement power of an external transmitter (when configured for this function)
Main Exc	Output power of the exciter currently on air (the one connected to the input of the RF modules)
Stdby Exc	Output power of the exciter currently on the internal dummy load
Temp	Status of the temperature alarm (sensor included in the combiner)
RF-Enb	RF output enable: "On" means that the RF combiner unit is giving its permission for the regular operation of the transmitter
Aux Fan	Switch for an auxiliary fan (not used in the current configurations)
SET1	Status of the output "SET1". See the Settings Menu
SET2	Status of the output "SET2"
SET3	Status of the output "SET3"
SET4	Status of the output "SET4"

```

MENU': R.F. Unit 01.
CHANNELS:
COMBINER:
Fwd..... 1000 W
Rfl..... 0 W
Input.... 8.1 W
P.A.V.... 50.5 V
Bios.V.....9.1 V.
Temp.....29.5 °C
Driver.I. 0.1 A
Mos-1.l.....8.1 A
Mos-2.l.....8.1 A
Mos-3.l.....8.2 A
Mos-4.l.....8.0 A

Total I.....32.4 A
Eff.....70 %

Alarms:
Temp.....OK
Fuse.....OK
Unit.Intl...OK

Temp.....OK
Action:
RF-enb.....on
    
```

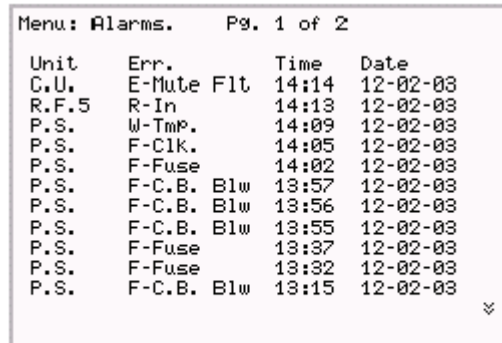
Figura 7-6 R.F. Unita' Menu'

7.1.6 R.F. Units menu

Information menu showing the status of the RF power amplifier modules. It is composed of 5 screens, one for each module, that can be scrolled using the arrow buttons.

Menu Line	Description
Fwd	Measurement of the forward power of the amplifier module
Rfl	Measurement of the forward power of the amplifier module
Input	Measurement of the driving power at the input of the amplifier module
V.P.A.	Measurement supply voltage of the module (generated from the switching power supply included in each module)
Driver	Measurement of the current absorbed by the preamplifier stage
MOS N	Measurement of the current absorbed by the MOS N amplifier module (each RF module contains 4 MOS modules)
I. Tot	Measurement of the total current absorbed by the RF module

Eff	Efficiency of the amplifier module, as a result of the ratio between the electrical power absorbed and the RF output power
Temp	Temperature alarm, Ok or Ko
Fuse	Status of the fuse of the RF module: Ok or Ko
Unit. Intl	State of the RF module interlock micro-switch
RF enb.	Enabled of power distribution from part of the module



Unit	Err.	Time	Date
C.U.	E-Mute Flt	14:14	12-02-03
R.F.5	R-In	14:13	12-02-03
P.S.	W-Tmp.	14:09	12-02-03
P.S.	F-Clk.	14:05	12-02-03
P.S.	F-Fuse	14:02	12-02-03
P.S.	F-C.B. Blw	13:57	12-02-03
P.S.	F-C.B. Blw	13:56	12-02-03
P.S.	F-C.B. Blw	13:55	12-02-03
P.S.	F-Fuse	13:37	12-02-03
P.S.	F-Fuse	13:32	12-02-03
P.S.	F-C.B. Blw	13:15	12-02-03

Figure 7-7 Alarms menu

7.1.7 Alarms menu

This screen describes all the registered events which are relevant to determine the probable causes of any dysfunction. The screen is composed of a variable number of pages (up to 10) in function of the number of events occurred. The last events in chronological order are shown in the first page and so on. To shift to the different pages, use the arrow buttons.

It is not possible to cancel the alarms in the display

Menu Column	Description
Unit	Module of the system which generated the failure
Err	Type of failure and description. The type of failure can be W (Wait) - the unit goes in stand-by until the cause of the failure is removed, R (Retry) - the unit is locked for a predefined time lag after which a reset attempt is launched, or F (Fault) - the unit is completely locked and requires the intervention of the user in order to remove the cause of the failure.
Time	Time (hrs and minutes) at which the failure occurred
Date	Date at which the failure occurred

```

MENU': Service:
  Fwd 10.00 Kw

  Unb:      0 W

                Fwd      Rf1
RF UNit1-on .. 1023 W      0 W
RF UNit2-on .. 1012 W      0 W
RF UNit3-on .. 1023 W      0 W
RF UNit4-on .. 1018 W      0 W
RF UNit5-on .. 1018 W      0 W
RF UNit6-on .. 1023 W      0 W
RF UNit7-on .. 1018 W      0 W
RF UNit8-on .. 1023 W      0 W
RF UNit9-on .. 1018 W      0 W
RF UNit10-on .. 1023 W     0 W
    
```

Figura 7-8 Service Menü

7.1.8 Service menu

This menu is normally used during the maintenance operations. When this screen is visualized, the Control Unit checks the status of the modules of the unit more frequently in order to have a visualization of the different parameters as fast as possible. When this menu is entered, all the secondary functions are interrupted, therefore a possible alarm may not be visualized and registered immediately; when exiting this menu all the alarms which were temporarily put in "stand-by" are registered. If the user sets some modules in OFF modality, these will be automatically reactivated when exiting the menu. This menu is deactivated after 60 minutes if no key is selected.

Menu Line	Description
Fwd	Forward power globally emitted by the amplifier
Unb	Unbalancing power dissipated in the combiner module.
RF UnitN - On	Fields used to switch ON and OFF the amplifier modules. Before the removal of an amplifier module for its replacement or maintenance switch it off with the help of the corresponding line.
Fwd	Forward power generated by the RF module
Rfl	Reflect power from the RF module

```

MENU': Settings:
Nominal Pwr.....100 % - ( 10.00 KW )
Low Pwr.....50 % - ( 5.00 KW )

Set      Assign      Limit
SET1     Ch-1             100 % - ( 10.00 KW )
SET2     Ch-1             50 % - ( 5.00 KW )
SET3     Ch-1             100 % - ( 1200 W )
SET4     Ch-2             100 % - ( 600 W )

Exc s wait time: 10 sec.
Talk address     4 sec.
Time ( h- m )   14-49
Date ( d-m-y )  12-02-02

Write Config.   All
    
```

Figura 7-9 Menü Settings

7.1.9 menu

This menu is used for the settings of the unit. It is therefore the menu which is used more often apart from the possible maintenance operations.

Menu Line	Description
Pwr. Out	Setting of the level of nominal power, expressed as a percentage of the maximum power level. This is the level that the PJ10KPS-C must reach when the Power Nominal button is pressed, except in case of dysfunction.
Pwr. Lower	Setting of the reduced power level, expressed as a percentage of the maximum power level. This is the level that the PJ10KPS-C must reach when the Power Lower button is pressed, except in case of dysfunction.
SET1	Level (Limit) at which the "Power Good" SET1 is launched. This level is expressed as a percentage of the full-scale to which SET1 is connected, indicated in the column Assign
SET2	See SET1
SET3	See SET1
SET4	See SET1
Exct. Wait time	Delay before assuming the on air exciter is faulty
Talk Address	Address of the unit in the RS485 network
Clock	Visualization and setting of the internal clock of the unit
Calendar	Visualization and setting of the internal calendar of the unit
L.P. Timer	Setting of the automatic power reduction feature: this can be "Auto" (enabled) or "Manual" (disabled). The feature consists in reducing the power to the low power level and then returning to the nominal power at fixed times. The start and stop times are set in this menu selecting "Auto".
Write Config	Button for the registration of the configurations in each module of the unit

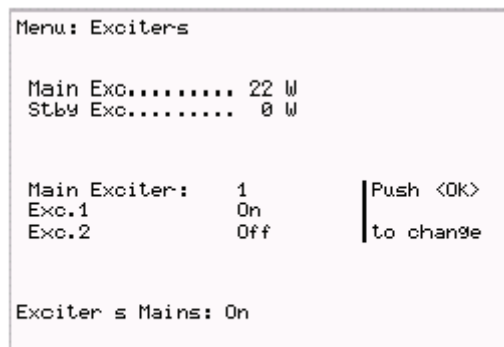


Figure 7-10 Exciters menu

7.1.10 Exciters menu

This menu is used to configure the settings of the exciters.

Menu Line	Description
-----------	-------------

Main Exc	Output power of the exciter currently on air
Stdby Pwr	Output power of the exciter currently on the internal dummy load
On Air Exciter	Visualization of the "on air" exciter. When positioning the cursor on this line, with the arrow buttons and by pressing Enter, it is possible to operate the switching between the on air exciter and the exciter on dummy load.
Exct.1	Status of the exciter 1. By positioning the cursor on this line with the arrow buttons and by pressing Enter it is possible to switch on and off the exciter.
Exct.2	Same as Exct.1 for the second exciter

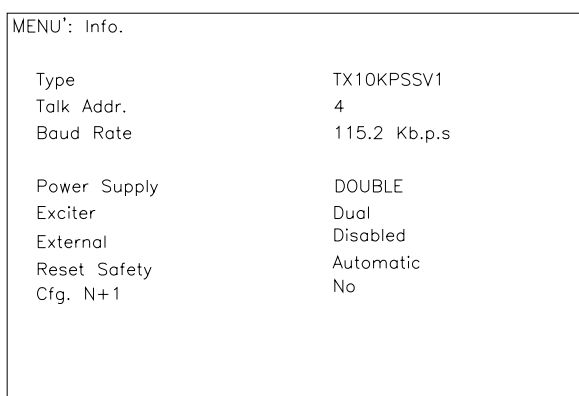


Figura 7-11 Menu' Info

7.1.11 Info menu

This screen informs the user about the configuration of the transmitter.

Menu line	Description
Menu Line	Description
Type	Configuration type (model of the transmitter)
Talk Addr.	Address of the RS485 port of the transmitter
Baud Rate	Baud rate of the serial port
Power Supply	Number of the transformer/rectifier carriages in the transmitter: this can be "Single" or "Dual"
Exciter	Number of the exciters in the transmitter: this can be "Single" or "Dual"
External	Checking of the external Fwd, Rfl, Unbal values (Enabled or Disabled)
Reset Safety	Resetting of the machine after a trip caused by the safety button. It can be "Automatic" or "Manual"
Cfg. N+1	Configuration of the transmitter as a N+1 system

MENU' Release:				
	Ad.	Cfg.	S.V.	H.V.
Control Unit	3	10000	4.00	1.0
Power Supply	1	10000	2.15	1.0
RF Combiner	4	10000	2.15	1.0
RF UNit1	8	10000	2.15	1.0
RF UNit2	9	10000	2.15	1.0
RF UNit3	10	10000	2.15	1.0
RF UNit4	11	10000	2.15	1.0
RF UNit5	12	10000	2.15	1.0
RF UNit6	13	10000	2.15	1.0
RF UNit7	14	10000	2.15	1.0
RF UNit8	15	10000	2.15	1.0
RF UNit9	16	10000	2.15	1.0
RF UNit10	17	10000	2.15	1.0

Figura 7-12 Menu' Release

7.1.12 Release menu

This menu show the address, the kind of configuration, the software version and the hardware version of all the microprocessor boards of the transmitter.

```

Menu: Modem Type: Auto
I.D. : 01 - Name: Example_station
S.C.N.: +1234567890
Info : NETWORKPROV Dial: ATDT
Phone : +2345678901
Phone : +3456789012
Phone : +4567890123
Phone :
Phone :
Phone :
Phone :
Phone :
Phone :
Phone :
Level : -65 dB Status: RXMSG
Retry : 2/5
    
```

Figura 7-13 Modem Menu

7.1.13 Modem menu

This screen informs the user about the configuration of the optional telemetry (see chap.9).

7.2 Parallel Interface

A parallel-type interface is mounted on the top of the PJ10KPS-C, in which the different signals are available through terminal blocks [Figure 7-13]. This interface is connected to the Control Unit from which it receives the different signals and to which the eventual commands are forwarded.

The card contains digital inputs, digital outputs and analog outputs. Among the digital inputs, a "copy" of all the possible orders that can be given locally to the unit by using the buttons of the control unit are displayed.

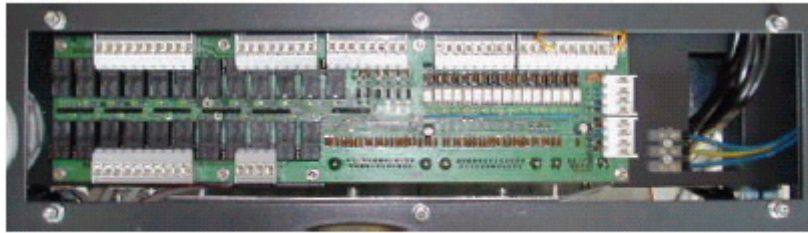


Figure 7-13 The parallel interface

The digital outputs supply information concerning the status of the PJ10KPS-C.

The analogue outputs enable the remote control of the most important parameters, for example the forward and reflected power.

This interface was designed for a maximum configurability and adaptability to the telemetry systems to which it may be connected. For example, each digital input can be configured through a jumper in order to be "active" when grounded or when connected to a supply source between +12V and +24V. The scheme of one generic digital input is shown in Figure 7-13 b). Please pay attention to the anti-parallel type optocouplers, so that if the jumper is closed between the pins 1 and 2, by grounding the DIGITAL INPUT, the input is active. On the contrary by closing 2 and 3, the input is active when the DIGITAL INPUT is connected to a positive voltage.

Each digital output can be configured individually as "Normally open " or "Normally closed " (NO or NC). In Figure 7-13 a) the scheme of a generic digital output is shown. Please note that when the jumper is closed between 1 and 2, the output is normally short-circuited with the common pin, while in the other case the circuit is normally open.

It is important to remember that the different commands can be given to the unit through the parallel interface only if the Local/Remote selector situated on the front panel is on the "Remote" position.

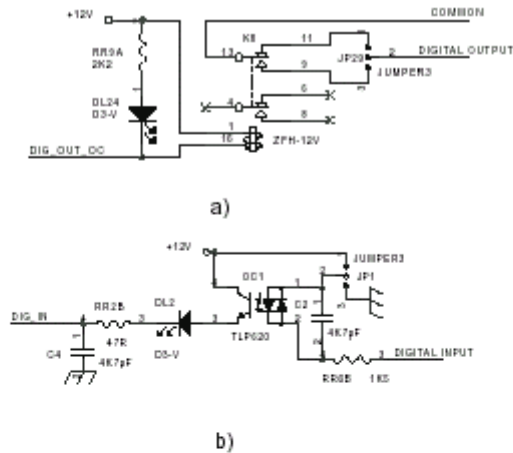


Figura 7-15 Digital I/O

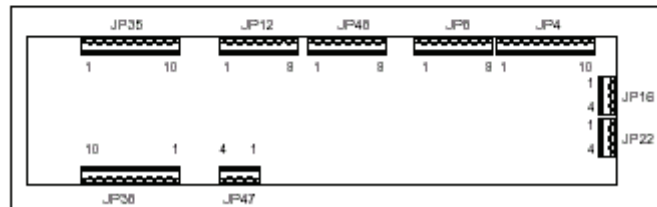


Figure 7-15 Parallel interface terminal blocks

The following table describes the function of each jumper of the parallel interface. The first column indicates the identifying number of the jumper as shown on Figure 7-14, the second indicates the name of the signal and the third column describes its function.

Clamp	Type	Name	Description
JP4/1	In	ON	Corresponds to the ON button of the control unit
JP4/2	In	STDBY	Corresponds to the STDBY button of the control unit
JP4/3	In	OFF	Corresponds to the OFF button of the control unit
JP4/4	In	EXT INH	External inhibition jumper. It is a "N.C." type jumper, which means that it must be active for the PJ10KPS-C to work.
JP4/5	In	AUX INH	Auxiliary external inhibition jumper. It is a "N.O." type jumper, which means that it must be not active for the PJ10KPS-C to work. It is "auxiliary" because even if nothing is connected to it the PJ10KPS-C works normally.
JP4/6	In	NOM PWR	Corresponds to the NOMINAL POWER button of the control unit
JP4/7	In	LOW PWR	Corresponds to the REDUCED POWER button of the control unit
JP4/8	In	AUDIO ALARM EXC. 1	Audio alarm of exciter 1. This input, when active, indicates an alarm on exciter 1. If the PJ10KPS-C is in automatic changeover modality, if the exciter 1 is on air and if this signal remains active for a time lag equivalent to the time setted in the Settings menu at line Exc. Wait time, the changeover procedure between the exciters will be started.
JP4/9	In	AUDIO ALARM EXC. 2	Same as AUDIO ALARM EXC. 1 for exciter 2.
JP4/10	/	GND	Grounding contact.

Clamp	Type	Name	Description
JP8/1	In	ALARM RESET	Corresponds to the ALARM RESET button on the control unit
JP8/2	In	RESRV. 1	Reserve 1 input. When this input is active, the failure is registered by the software in the Alarms menu. For example it can be connected to a switch that indicates that the door of the station is open or to a sensor of a power reserve of an electric generator. In this way, by consulting the menus of the unit, it is possible to trace the moment at which (time and date) the failure occurred.
JP8/3	In	RESRV. 2	Same as JP8/2
JP8/4	In	RESRV. 3	Same as JP8/2
JP8/5	In	RESRV. 4	Same as JP8/2
JP8/6	In	EXCITER CHANGEOVER CMD	This command launches the changeover procedure between the exciters. It has the same function as when you press the OK button when selecting line On air exciter in the menu Exciters. In order to launch the changeover between the exciters through this command, the manual changeover modality should be formerly selected through the correspondent button on the control unit or through the JP8/7 jumper, having however the unit in "Remote" modality.
JP8/7	In	EXCITER CHANGEOVER	Corresponds to ther EXCITER CHANGEOVER button of the control unit
JP8/8	/	GND	Ground
JP16/1	Out	+12V dc	Power source. A maximum of 100 mA can be absorbed between this jumper and JP16/2. This power source can be used if the user wants to enter the comands following a positive logic (high voltage - active comand)
JP16/2	OUT	+12V dc	Same as JP16/1
JP16/3	/	GND	Ground
JP16/4	/	GND	Ground
JP22/1	I/O	TX/RX +	Bus RS 485. Please note that this serial port is operational only when the unit is in "Remote" modality.
JP22/2	I/O	TX/RX -	Bus RS 485
JP22/3	/	LINE TRM	Line termination for bus RS 485
JP22/4	/	LINE TRM	Line termination for bus RS 485
JP48/1	/	GND	Ground
JP48/2	/	GND	Ground
JP48/3	Out	FWD PWR	Forward power. Analogical output, 3.9V for 5000W
JP48/4	Out	RFL PWR	Reflect power. Analogical output, 3.9V for 1200W
JP48/5	Out	OUT AIR TEMP	Temperature of the air at the output of the chimney. Analogical output, 0V for -50°C, 3.9V for 100°C
JP48/6	Out	V BUS	Voltage at the output of the transformer/rectifier. Analogical output, 3.9V for 80V, 0V for 0V.
JP48/7	Out	EFF.	General efficiency. Analogical output, 3.9V for 100%, 0V for 0%.
JP48/8	Out	OUT DAC 6	Reserved for future applications.
JP12/1	Out	CMN MUTE 1	Common contact MUTE 1 (see JP12/2).

Clamp	Type	Name	Description
JP12/2	Out	MUTE 1	MUTE exciter 1. Digital output, active when exciter 1 is inhibited by the control unit. Like all the digital outputs on the parallele interface, it can be configurated through jumper as normally open or normally closed. This output has a common contact dedicated to this function (JP12/1).
JP12/3	Out	CMN MUTE 2	Common contact MUTE 2 (see JP12/4).
JP12/4	Out	MUTE 2	MUTE exciter 2. Digital output, active when exciter 2 is inhibited by the control unit. This output has a common contact dedicated to this function (JP12/3).
JP12/5	Out	CMN LOCAL	Common contact LOCAL (see JP12/6).
JP12/6	Out	LOCAL	LOCAL/REMOTE status. Digital output, active when the PJ10KPS-C is setted in local modality. This output has a common contact dedicated to this function (JP12/5).
JP12/7	Out	CMN MAINS	Common contact MAINS (see JP12/8).
JP12/8	Out	MAINS	MAINS alarm, active when are present problems on the alimentation
JP47/1	Out	AUDIO ALARM	"AUDIO" alarm (see JP4/8 and JP4/9). This output is active when the on air exciter is in audio alarm status. This output has a common contact dedicated to this function (JP47/2).
JP47/2	Out	CMN AUDIO ALARM	Common contact AUDIO ALARM (see JP47/1).
JP47/3	Out	COMMON RL3	Common contact shared from the outputs JP38/1-10.
JP47/4	Out	COMMON RL3	Parallel contact with JP47/3.
JP35/1	Out	RESRV. 1	Reserve 1. Digitale output, active when the INPUT RESERVE 1 input (JP8/2) is active. The common contact of this output is RL4 (JP35/5)
JP35/2	Out	RESRV. 2	Same as JP35/1, corresponds to INPUT RESERVE 2. The common contact of this output RL4 (JP35/5)
JP35/3	Out	RESRV. 3	Same as JP35/1, corresponds to INPUT RESERVE 3. The common contact of this output RL4 (JP35/5)
JP35/4	Out	RESRV. 4	Same as JP35/1, corresponds to INPUT RESERVE 4. The common contact of this output RL4 (JP35/5)
JP35/5	Out	COMMON RL4	Common contact shared between different digital outputs (JP35/1-4)
JP35/6	Out	SET1	Digital output, active when the parameter SET1 is active (see menu Settings). The common contact of this output RL5 (JP35/10).
JP35/7	Out	SET2	Same as JP36/6, corresponds to SET2. The common contact of this output is RL5 (JP35/10).
JP35/8	Out	SET3	Same as JP36/6, corresponds to SET3. The common contact of this output is RL5 (JP35/10).
JP35/9	Out	SET4	Similar to JP36/6, related to SET4. The common contact of this output is the RL5 (JP35/10).
JP35/10	Out	CMN RL5	Common contact shared between the different digital output (JP35/6-9)
JP38/1	Out	EXC. ON AIR	Digital output, active when the exciter 1 is on air, and not active when the exciter 2 is on air. common contact of this output is the RL3 (JP47/3).
JP38/2	Out	AUTO/MAN	Digital output, active when the PJ10KPS-C is in changeover mode as regards the exciters. The common contact of this output is RL3 (JP47/3).

Clamp	Type	Name	Description
JP38/3	Out	LOWER POWER	Digital output, active when the PJ10KPS-C is set for the lower power level. Common contact of this output is the RL3 (JP47/3).
JP38/4	Out	NOMINAL POWER	Digital output, active when the PJ10KPS-C is set for the nominal power level. common contact of this output is the RL3 (JP47/3).
JP38/5	Out	OFF	Digital output, active when the PJ10KPS-C is set for the lower power level. The common contact of this output is the RL3 (JP47/3).
JP38/6	Out	STDBY	Digital output, active when the PJ10KPS-C is set for the lower power level. The common contact of this output is the RL3 (JP47/3).
JP38/7	Out	ON	Digital output, active when the PJ10KPS-C is set on ON mode. The common contact of this output is the RL3 (JP47/3).
JP38/8	Out	FAULT	Digital output, active when the PJ10KPS-C is set on FAULT mode. The common contact of this output is the RL3 (JP47/3).
JP38/9	Out	WAIT	Digital output, active when the PJ10KPS-C is set on WAIT mode. The common contact of this output is the RL3 (JP47/3).
JP38/10	Out	WARNING	Digital output, active when the PJ10KPS-C is set on WARNING mode. The common contact of this output is the RL3 (JP47/3).

7.3 Power supply section

The power supply used by the PJ10KPS-C is AC three phase with neutral at 380 V. The power supply for the RF amplifier modules is DC 80 V, stabilized inside the modules themselves by a built-in switching power supply.

The power supply section of the PJ10KPS-C is composed of a three phase transformer and a rectifier circuit to feed the RF modules. Some features of the power supply section are the following:

- PF > 0.94. This value of the power factor is got thanks to specific solutions, such as power inductors use. The result is a wave shape of the absorbed current particularly cleaned and meeting the requirements of the most demanding users.
- Redundancy. Where an uninterrupted service is demanded, is possible to add a second power supply chart. The functioning of the max power output is warranted by a power supply only, so the double power supply use allow to be used as back up in case of fault of one of them.
- Easy access. The power supply section is located on a chart with wheels for an easy take out from the cabinet and easy transportation. When the configuration of the equipment is with double power supply chart is possible to stop (take out and service) a section without turn off the equipment.
- The power supply section of the PJ10KPS-C is checked by a microprocessor card included in the rack of the equipment. This card manages one or two more power supply charts, the cooling blower and the several alarms systems such as the emergency "not aus" button.

7.3.1 Working Principles

The Power Supply is checked by a microprocessor unit completely independent in the alarming functions and activity respect to the control unit. The interchanges signals between

the two units are present on a flat cable of 20 poles named “data communication and command bus”. The signals present on the bus that are related to the power supply section are: ON, Stby, Alarm, Tr+/Tr-.

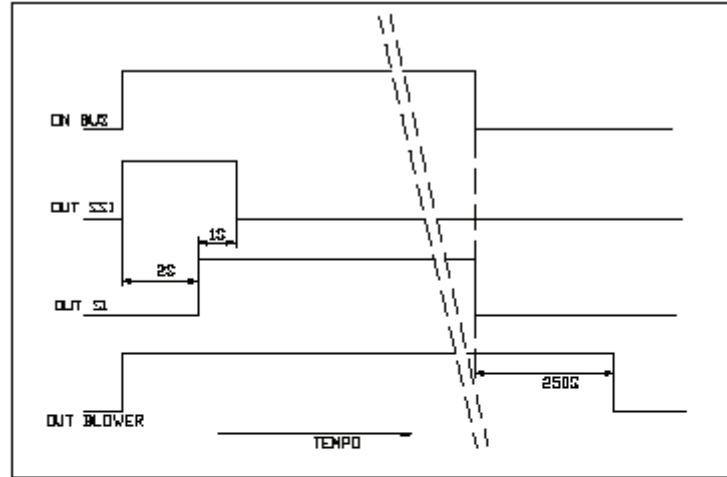


Figure 7-16 Time chart of the carriages contactors

Bus Command	Soft-Start contactor	Start Contactor	Fan Contactor	STDBY Output
OFF	0	0	0	Active
STDBY	0	1	1	Not Active
ON	0	1	1	Not Active

Table 7-1 Time chart of the carriages contactors

Signal	Function
ON	When the control of the power supply section notices a +12V on this signal, the start up cycled of the power supply carriages is activated. The cycle is divided in two phases: the first contactor enables the power transformer through power resistors, so that the possible current peak at start-up is reduced; two seconds later, the second contactor is excited, so that the transformer is directly fed. After an additional delay of a second, the first contactor is released. At this point, the start-up cycle is terminated and the STDBY line is released.
STDBY	When this signal is at ground, the RF modules are forced on a RF mute mode. The power supply section maintain on a stand-by position the control bus until the start-up cycle is ended, or when the ON signal is not present, or at the end in all the conditions that are controlled by this section that can affect the safety of the equipment. When all the checked conditions are satisfactory the signal is released.
Alarm	When this signal is at ground the control unit checks all the devices present on the bus to register and manage eventual alarms. When a signal or an alarm that affect the power supply section is revealed, the processor that is used to control it orders to the line to go down so to communicate to the control unit the event.
Tr+/Tr-	These signals are used for data communication. The levels meet RS485 standard, the speed is 115 kb/s. Please note that an eventual failure on these signals doesn't affect the complex functioning of the equipment.

In addition to the contactors that permit the soft-start function, this unit control the cooling blower function. This is switched on together with the On command, while, when the equipment is in OFF mode, the blower relay stops to be driven after about 4 minutes. This laboursaving device is used to avoid that temperature peaks to be present at the internal of RF modules. This procedure of post-ventilation is used for all conditions of equipment stops, both in case of human will or in case of alarm.

Table 7.1 contains a schematic of the output of the power supply section. The graphic

display of the contactor status during the time is reported in the Picture 7-16.

7.3.2 Configurations

The power supply section of the PJ10KPS-C has the following configuration possibilities:

- 1 Equipment with single power supply carriage
- 2 Equipment with double power supply carriage
- 3 Equipment with automatic reset of the Safety function at the emergency button release
- 4 Equipment with reset of the Safety function to be done manually by pushing the button.

The standard configuration of the equipment includes the points 1 and 3.

7.3.3 Logic control Signals

The power supply section of the PJ10KPS-C constantly controls the logic signals that can be divided in general signals (related to the equipment in its complex) or carriages signals (related to the single power supply carriages). The status of these signals can be checked on the Power Supply Menu in the control unit.

When a fault is detected in one of the general signals, the PJ10KPS-C is blocked either temporarily blocked or until the intervention of the maintenance staff, depending on the type of signal. The general signals with relative meaning and managing mode are the following:

Signal	Function
Safety	<p>This signal in alarm status when the emergency button is pushed. In this case the feed line to the several contactors is immediately sectioned, for which an instant arrest of all the subject parts to power is had; the exciters remain however operational.</p> <p>In the meantime a signal send a message to the control local unit of the current conditions. To restore the functioning of the equipment the emergency button has to be reload.; if the equipment is configured in mode 3), the start-up cycle is activated after two seconds. If the power supply is configured in mode 4) it will be necessary to push the SAFETY RESET button to restart the equipment. The safety signal is not memorized on the events menu.</p>
Mains	<p>This signal is generated by an external device that control that the power supply current meets the limits of the functioning and that the R,S,T direction of progression of the phases is correct. If the mains is on alarm status, The equipment stops working, including the feeding of the exciters. When the signal return, an automatic restart occurs. All the time that an alarm of this type is present, a relative message in the menu alarm of the control unit is memorized.</p>
Air pressure	<p>A pressure sensor informs the local unit if the cooling air flow is not correct ; the intervention of the sensor stops the equipment temporarily with the disconnection of the power supply contactors of the power transformers. When the signal returns an automatic restart of the PJ10KPS-C takes place. An oportune message is memorized in the Alarm menu in the control unit of the unit all the times that this signal.</p>
Blower Motor Protector	<p>The intervention of the ground protection of the motor protector put the equipment on Fault mode. This condition requires the presence of an operator to restore the functioning of the equipment. In order to attempt to restart it's necessary to reload the motor protector and push the ALARMS RESET of the control unit. Each time that this signal interveens an oportune message is memorized in the alarm menu of the control unit.</p>

The “carriage signals” are related to the status of the single carriages. A possible alarm status in one of these signals has a different effect on the transmitter depending on the

number of the included power supply carriages, single or dual. While in the first case the PJ10KPS-C is stopped in case of a fault, in the second case the spare carriages is still able to supply all the required power; in this case the fault is signalled by the LED Warning on the front panel.

The meanings of the carriage signals are the following:

Signal	Function
Fuse 1	This signal, meaning "Carriage 1 Fuse" signal is in fact composed of the series of all the safety interlocks of the carriage. If this signal is in the alarm status, it will be necessary to determine which of the following possible reasons is causing it: AC power fuse, micro switch of the chart connected. The magneto-thermic switch, command connector coils, control signals connector, threephase power connector.
Trafo 1 OH	This signal, meaning "Overheating transformer 1" (Trafo 1 Over Heat), is connected to the safety thermal switches. There are two different sensors: one is on the transformer lamellar plate, the other is on the rectifier heat dissipator. The intervention of one of these two devices stops temporarily the equipment on WAIT mode. When temperature goes below the threshold, the transmitter will automatically restart. The temperature of intervention is 90°C, and in case this alarm arises, it will be recorded with a message in the alarm menu on the control unit.
Fuse 2	As Fuse 1, for carriage 2
Trafo 2 OH	As Trafo 1 OH, for carriage 2

If the signal Fuse X is on alarm, in order to restore the regular functioning of the equipment it is necessary to identify the cause of the fault. The following table resumes the points to be verified in order to find the cause of malfunctioning:

Signal	Condition
Power fuse	Verify that the LED on the rectifier card is switched off [Figure7-18]
Chart micro switch	Verify that the power supply carriage is perfectly attached to the bottom and that pushes the micro switch [Figure 7-17 b)]
Magneto-thermic chart Switch	Verify that the switch is on position I [Figure 7-17 a)]
Control signals connectors	Verify that the plug is connected in the right way [Figure 7-18]
Command coils connector	Verify that the plug is connected in the right way [Figure 7-18]
Three-phase power connector	Verify that the plug is connected in the right way [Figure 7-17 a)] Note that the handle on the left side of the connector has to be pulled toward the front of the transmitter to block the connector in its place.

7.3.4 Control card

The functions of this microprocessor card are the following:

- Protection of the power supply section
- Communication with the control unit
- Analogue parameters measurement

The card is installed in the rack under the RF modules site, in a metallic box where it's included the control card of RF combiner [Figure 7-18 a)]. This card needs two analogue tunings: air input temperature and Bus DC voltage (not stabilized). For the tuning use the Power Supply menu of the control unit and identify the appropriate trimmers in Figure [7-18 b)].

All the input digital signals are of "PNP" type, the common power supply is 12Vdc; the line of 12 Vdc is protected against the ground short circuit through a self-restoring fuse (PTC). An

possible short circuit on this supply will cause trip the machine. Eventual messages of fault in correspondence of a short circuit on this line won't be valid.

To restore the supply is necessary to remove the short circuit condition and switch OFF the equipment for about a minute in order to let the fuse self-restore.

7.3.5 Interface Board

The control card of the power supply is connected with the actuators through an interface board [Figure 7-19].

All the output signals from the control card are interfaced through power relays and signal relays. On the relay coils a signalling LED is present and indicates the command status on the control unit: the LED turned ON indicates that the coil is excited. All the power contacts are equipped with noise suppressing network.

The feeding of the relay is supplied from a line protected against the short circuit through self-reloading ground protections.

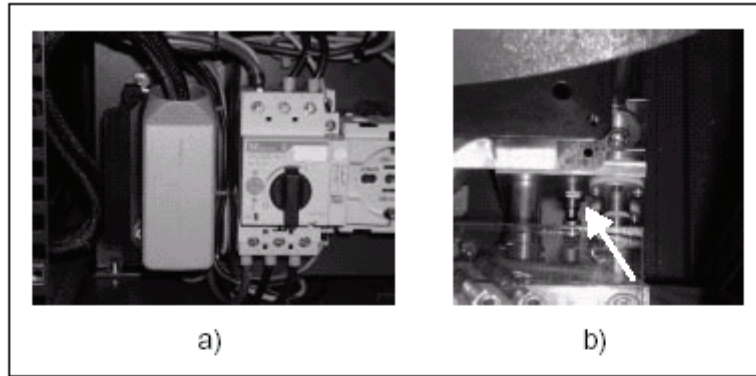


Figura 7-17 Carriages check points

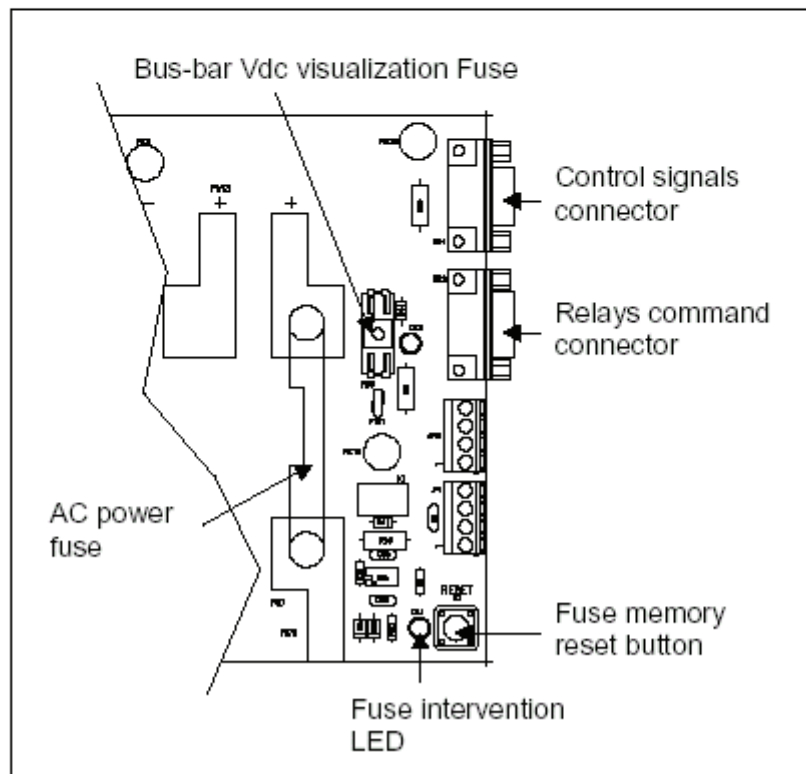


Figura 7-18 Rectifiers board check points

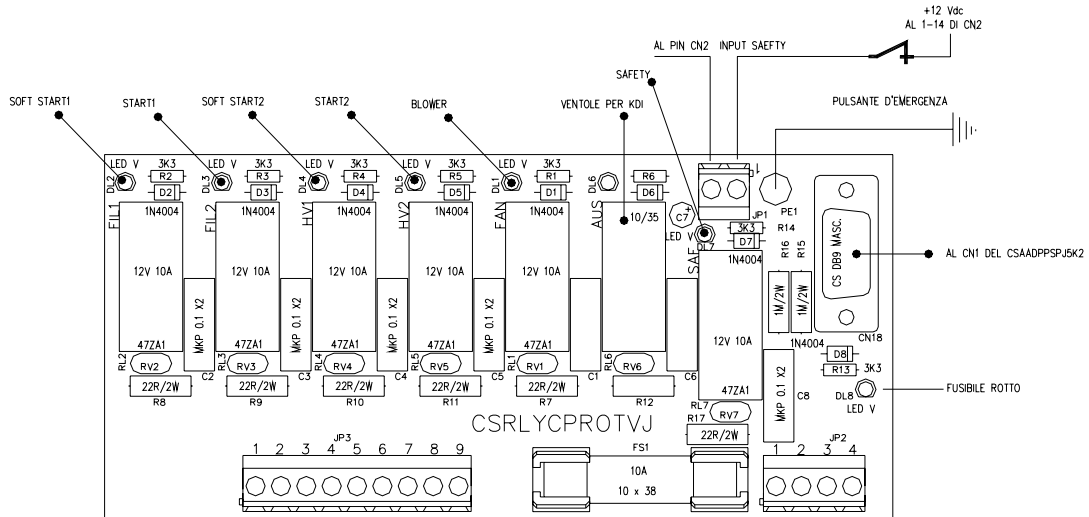


Figure 7-19 Relay Interface Card

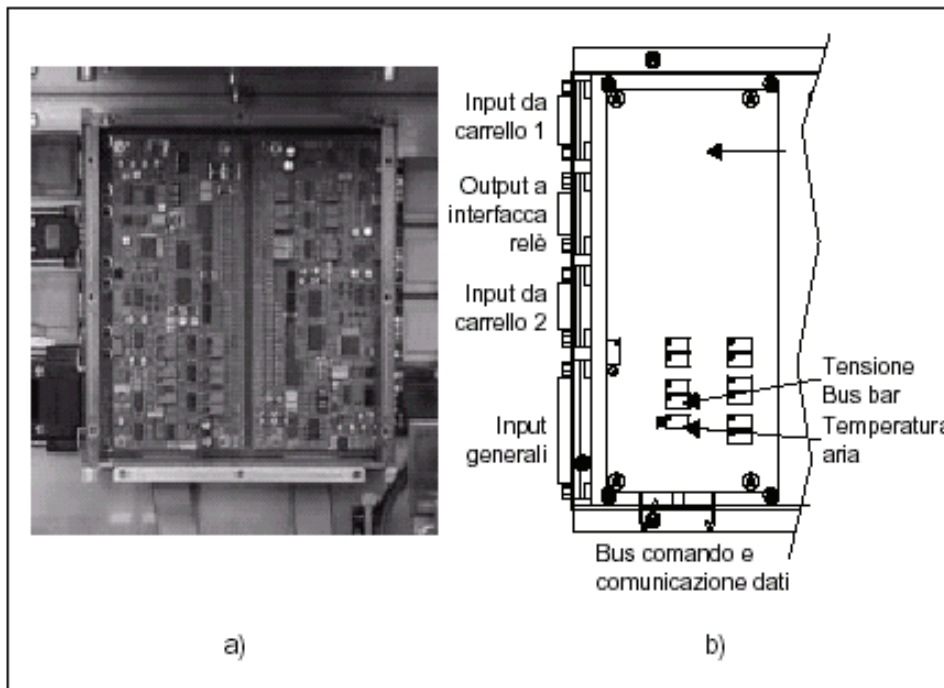


Figure 7-20 Control alimentation Card

The signals coming from the control card are of "NPN" type, actives when ground directed. The function of the relay RL7 ("SAF" on the silk-screening) is to protect the personnel: it breaks the common power supply of the power contactors, That are supplied only when all the safety micro-switches are closed.

To protect the card is selected a FS1 fuse of the type 30x38 of 10A.

The turn on of the DL8 led indicates the fault of the FS1 fuse. This interface is connected to the local unit control through the CN18-CN1 connector.

7.3.6 Replacing the carriage

The following procedure has to be followed when it's necessary to replace a power supply carriage. Please note that if the transmitter is fitted with just one power supply carriage, it will be necessary to switch it off to replace the carriage, while if it has two of them it is possible to continue transmitting normally also during this operation.

- 1 Turn the power disconnecting switch on position 0 (in the case of one power supply carriage)
- 2 Turn the carriage switch on position Off
- 3 Disconnect the three phase supply connector from the carriage, the connector of the control signals and the one of the command contactors.
- 4 Remove the screws that hold the bottom bar of the rack
- 5 Remove the carriage from its site
- 6 Insert the new carriage
- 7 Reassemble the bar and fix it in place with the screws
- 8 Reconnect the three connectors
- 9 Turn again the power disconnecting switch on position I
- 10 Turn the power switch on position I (if it had been turn Off previously)

7.4 RF Modules amplifier

The PJ10KPS-C has 10 RF amplifier modules able to supply 1.2 kW each. The modules are independent from each other, self-controlled and self-protected.

Each amplifier module includes a first stage with a variable gain, based on the MOSFET BLF175. The RF signal amplified by the driver is divided by 4 by a Wilkinson splitter, then sent to 4 identical modules based on BLF278, combined again and filtered by a band-pass filter.

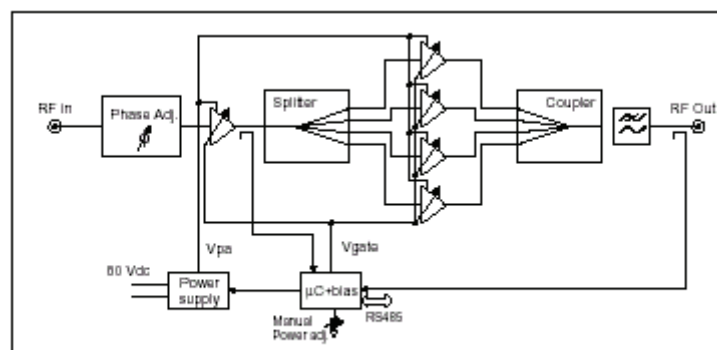


Figure 7-21 Block diagram of a RF module

Each RF amplifier module is controlled by a microprocessor card, connected through a RS485 bus to the other microprocessor cards of the machine.

The switching power supply included in each amplifier module generates the feeding supply of the active devices. The generated voltage is adjustable and commanded by a microprocessor card included in the module. The card adjusts the supply and the polarization current (gate) of the modules, thus controlling the emitted power.

On each module there is a trimmer for the manual adjustment of the power. The trimmer acts as a limiter. This means that if the automatic adjustment of the power sets a nominal output value, the trimmer can only reduce it, and not increase it.

7.5 Alarms

The menu Alarms of the control unit reports all the events connected to possible malfunctioning of the equipment or due to external causes.

Each registration contains the reference to the concerned module, the kind of event and its date and hour.

The module that detected the event is indicated by one of the following acronyms:

- C.U. Control Unit
- P.S. Power Supply
- R.F.X Amplifier module X (from 1 to 10)
- R.F.C Combiner/Splitter

The type of event allows to identify the origin and the consequence of the fault. The first letter of the type of event (eg F-C.B. Blw) can be one of the following:

Letter	Event
E	"Error", event that doesn't cause the interruption of the supply of power, but can reduce the functions of the equipment (e.g cannot be done the changeover function of the exciters)
F	"Fault", event that causes the block of the equipment and requires the intervention of an operator for the restart.
W	"Wait", event that causes the temporary block of the piece of equipment equipment, that will be removed as soon as the problem is solved.
R	"Retry", event that causes a temporary block of the piece of equipment, that will effect a restart attempt after a fixed lapse of time.

The possible type of events are listed in Table 7-2

Code	Meaning
Control Unit	
E.Intl	The external interlock is active
A.Intl	The auxiliary interlock is active
Audio-1	The Audio alarm of exciter 1 is active
Audio-2	The Audio alarm of exciter 2 is active
Ris-1	The RESERVE 1 input is active
Ris-2	The RESERVE 2 input is active
Ris-3	The RESERVE 3 input is active
Ris-4	The RESERVE 3 input is active
Mute Flt	"Mute fault": the mute commands (i.e. the interlock commands for the exciters) are not working, they are not connected or the connection is wrong
Xchg Exc	A changeover of the exciters has been performed
Cfg. N+1	The machine is in Fault status because two changeover attempts have been performed (N+1 configuration)
Power Supply	
T1 -	The power supply carriage 1 is overheated
F1 -	One of the fuses or of the interlocks of the power supply carriage 1 is blown or not closed
Tmp.	The air inlet temperature is too high
W-T2	The power supply carriage 2 is overheated
T1 W-T2	The power supply carriage 1 and 2 are overheated

Code	Meaning
F1 W-T2	One of the fuses or interlocks of carriage 1 is blown or not closed, the power supply carriage 2 is overheated
Prs	The air pressure generated by the blower is not sufficient
F-F2	One of the fuses or of the interlocks of the power supply carriage 2 is blown or not closed
T1 F-F2	One of the fuses or interlocks of carriage 2 is blown or not closed, the power supply carriage 1 is overheated
F1 F-F2	One of the fuses or of the interlocks of both the power supply carriages 1 and 2 are blown or not closed
Mains	The AC power supply is out of its voltage range, or the phase sequence is not correct
C.B. Blw	The circuit breaker of the blower blocked it
Fuse	One of the fuses or of the interlocks of the power supply is blown or open
O.Tmp.	The power supply is overheated
Combiner	
Fwd	Forward power above its limit
Rfl	Reflected power above its limit
O.dvr In	Overdrive (main exciter)
O.dvr Ld	Too much power dissipated on the internal dummy load (stand by exciter)
Unbal	Unbalancement power above its limit
Rej.I.T.	Overheating of the unbalancement (rejection) load resistors
Exhaust	Exhaust overheating
SWR	SWR above its limit
O.Tmp.	Internal overheating
R.F. Units	
Fwd	Forward power above its limit
Rfl	Reflected power above its limit
In	Input power above its limit
Tmp.	Overheat of the RF module
Drv. I	Driver current above its limit
Mos 1 I	Current of the MOS module 1
Mos 2 I	Current of the MOS module 2
Mos 3 I	Current of the MOS module 3
Mos 4 I	Current of the MOS module 4
Eff.	Efficiency too low
Fuse	Module's fuse broken
O.Tmp.	Overheating ov the module's heatsink

7.6 Combiner and divider

7.6.1 Control Unit

The RF combiner section too is equipped with it own microprocessor control unit. This is very important for the functioning of the whole transmitter because it checks the foldback line of the several RF modules. The value of the output power is managed directly by this micro controller. In case of fault of this control unit or if a problem arises in the communication bus, the transmitter will continue working at the same power level set in the field "nominal power" of the control unit.

To this unit is assigned the task to limitate and stabilize the output power. When one of the parameters reaches its safety limit for the right functioning of the machine, the power level decreases progressively. The feedback is completely of analogue type, made through a voltage present on the control bus. The voltage is between the maximum of 3.9 V (this

indicates that the transmitter is supplying the maximum power) and 0 V (minimum power).

This section also controls the maximum permitted power level of the exciters, with a programmed alarm of “Fault” type. If this level is exceeded the transmitter turns itself OFF and the AC supply of the exciters is cut until the operator pushes the Alarms Reset button.

8 Technical Notes

This chapter contains the references to the technical appearances that more frequently could be necessary for intervene on the PJ10KPS-C.

8.1 Microcontroller board Trimmers

In the PJ10KPS-C are present microcontroller boards, one for each 1.2 kW module, one for the control of the power supply and one for the control of the combiner. The boards are identical, but in each the trimmers have diverged meaning. In figure 8.1, "RFM" refers to the RF module, "PS" to the power supply and "CMB" to the combiner. TR12 is set so that VREF is 3.3 V.

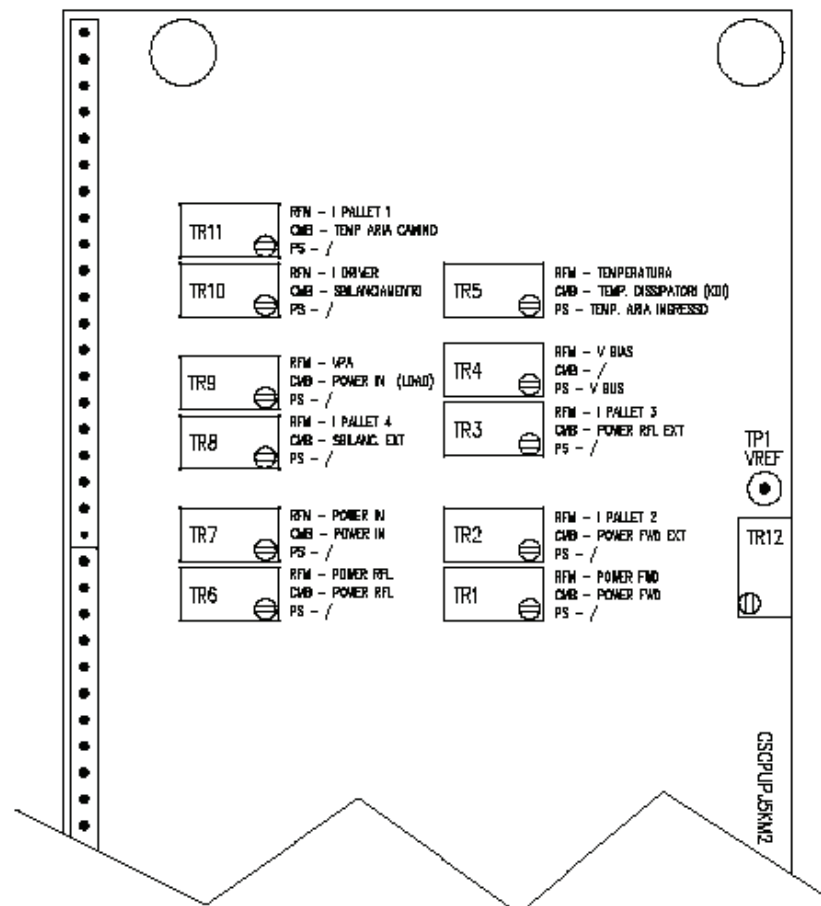


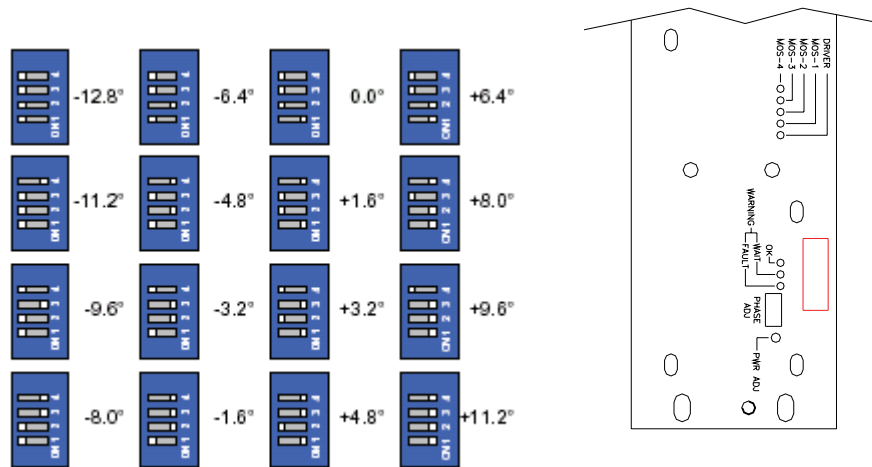
Figure 8-1 Microcontrol board Trimmers

8.2 Phase Adjustment of RF modules

Each PJ10KPS-C RF module have a dip-switch (accessible on the frontal panel) for the regulation of the phase of the RF signal generated. The phase of each RF module could be modified independently to steps of 1.6° from -12.8° to $+11.2^\circ$ (Figure 8.2).

Normally, the modules comes furnished with the phase regulated for 0° , that it is the optimal position for the correct operation of the machine on all the frequency band. In some cases

could result useful use the regulations of phase for minimize the unbalanced power dissipated. To this purpose, it preferable of use the SERVICE menu, in which this value comes adjoined in real time.



8.3 Splitter board trimmers

On the entry splitter board are present two trimmers for the regulation of the measure of the emitted power from the two exciters. These measures are those visible in the EXCITERS menu.

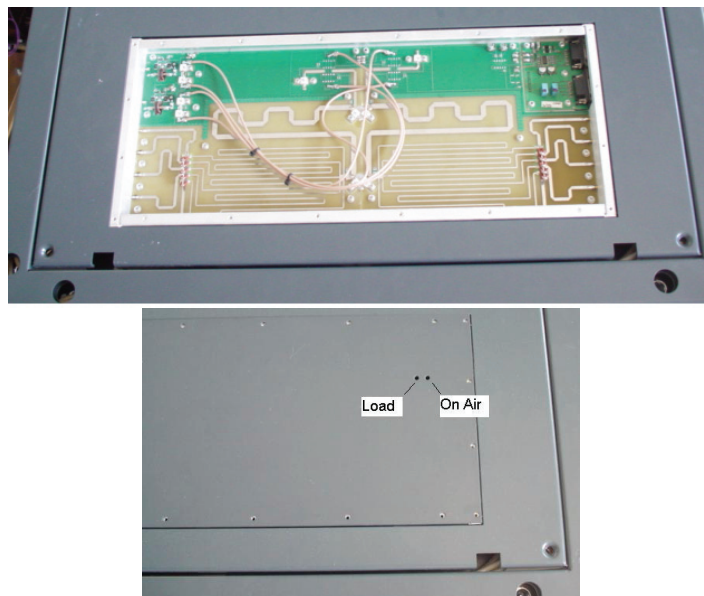


Figure 8-3 Trimmers for the read power of exciters

On the circuits of power measure of the exciters there are two compensators to maximize the directive and minimize the operation error measure of the frequency of operation.

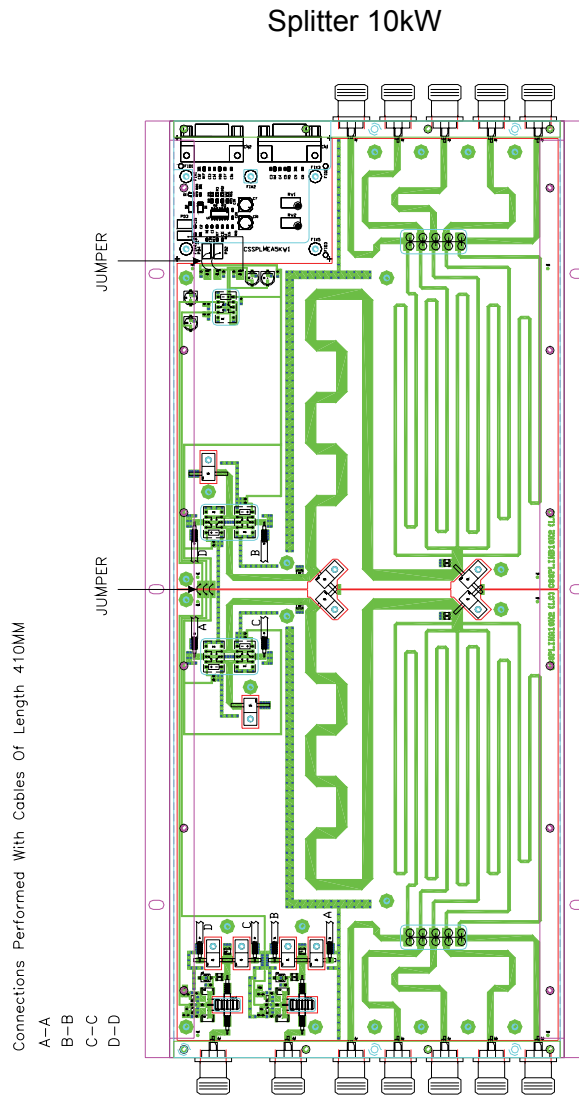


Figure 8-4 Splitter read head

8.4 Parallel Interface

The parallel interface present on the roof of the PJ10KPS-C is described into the 7.2 chapter. In following a small description reassumed the functions assigns to the clamps.

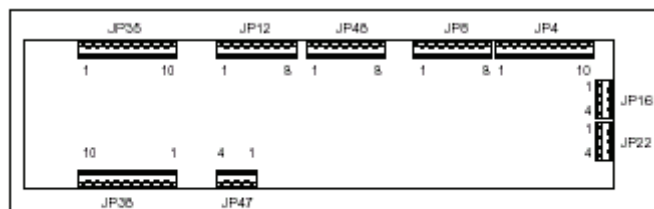


Figure 8-5 Parallel interface clamps

JP4	1	In	ON	
	2	In	STDBY	
	3	In	OFF	
	4	In	EXT INH	
	5	In	AUX INH	
	6	In	NOM PWR	
	7	In	LOW PWR	
	8	In	AUDIO ALARM EXC. 1	
	9	In	AUDIO ALARM EXC. 2	
	10	/	GND	
JP8	1	In	ALARM RESET	
	2	In	RESRV. 1	
	3	In	RESRV. 2	
	4	In	RESRV. 3	
	5	In	RESRV. 4	
	6	/	EXCITER CHANGE CMD	
	7	In	EXCITER CHANGEOVER	
	8	/	GND	
JP16	1	Out	+12V dc	
	2	Out	+12V dc	
	3	/	GND	
	4	/	GND	
JP22	1	I/O	TX/RX +	
	2	I/O	TX/RX -	
	3	/	LINE TRM	
	4	/	LINE TRM	
JP48	1	/	GND	
	2	/	GND	
	3	Out	FWD PWR	
	4	Out	RFL PWR	
	5	Out	OUT AIR TEMP	
	6	Out	V BJS	
	7	Out	EFF.	
	8	Out	OUT DAC6	
JP12	1	Out	COMMON MUTE 1	
	2	Out	MUTE 1	
	3	Out	COMMON MUTE 2	
	4	Out	MUTE 2	
	5	Out	COMMON LOCAL	
	6	Out	LOCAL	
	7	Out	COMMON MAINS	
	8	Out	MAINS	
	JP47	1	Out	AUDIO ALARM
		2	Out	COMMON AUDIO ALARM
3		Out	COMMON RL3	
4		Out	COMMON RL3	
JP35	1	Out	RESRV. 1	
	2	Out	RESRV. 2	
	3	Out	RESRV. 3	
	4	Out	RESRV. 4	
	5	Out	COMMON RL4	
	6	Out	SET1	
	7	Out	SET2	
	8	Out	SET3	
	9	Out	SET4	
	10	Out	COMMON RL5	
JP38	1	Out	EXC. ON AIR	
	2	Out	AUTOMAN	
	3	Out	LOWER POWER	
	4	Out	NOMINAL POWER	
	5	Out	OFF	
	6	Out	STDBY	
	7	Out	ON	
	8	Out	FAULT	
	9	Out	WAIT	
	10	Out	WARNING	

Tabelle 8-1 Function of the parallel interface clamps

8.5 RF module I/O Interface

The control unit of the PJ10KPS-C communicates continually with all the microprocessor boards contained in the machine. All the boards are equal, but in function of the position in which are installed they use configuration software and different address. For the boards that control the RF amplifiers modules, the addresses have mailed from the respective boards of I/O interface, installed to the inside of the rack. This means that the modules are perfectly interchangeable, and they engage the address to the action of the insert in the rack automatically.

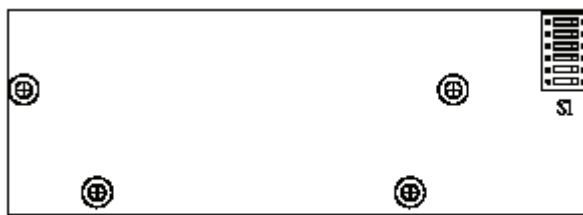


Figura 8-6 Dip switch I/O interface board

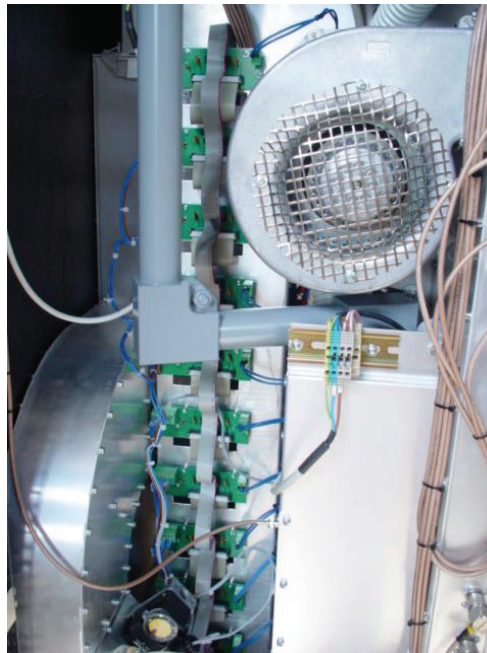


Photo in reference to the figure 8-6 (ten I/O interface board)

The address assigned to the module is mailed by a dip-switch on the interface board.

In figure 8-7 are brought back the configurations assigned to the different settings.

The RF module 1 (that more to left looking at the machine) have address 8, the 2 has address 9 and so on until at 17. The other addresses are reserved for future uses.

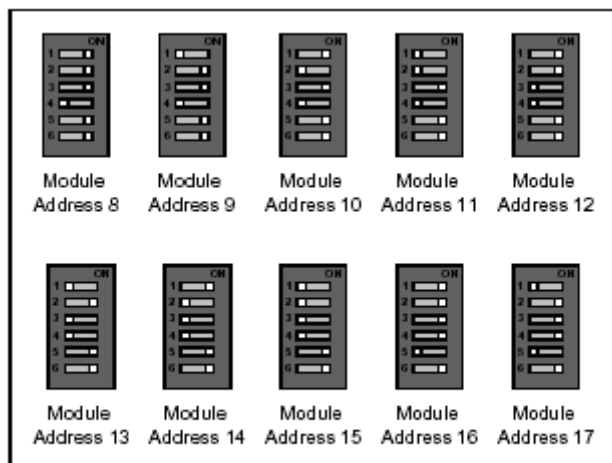


Figura 8-7 Addresses regulation of RF modules

8.6 Services supply

The services of PJ10KPS-C are supplied at 220V through a dedicated transformer.

Between the services, are included the microcontroller cards of RF modules, those of the combiner and power supply and the control unit.

Supplying the services of the PJ10KPS-C with an UPS (Uninterruptible Power Supply), the machine also in case of absence of mains power can be managed, naturally limitedly to the functions available (for example configuration or interrogation of the alarms registry). The

normal configuration of the machine previews that the services are directly supply through the connection to the electrical mains of the machine, in order to insert an UPS is sufficient put it between the VDE on the roof, after have removed the bridge that comes supplied of series.



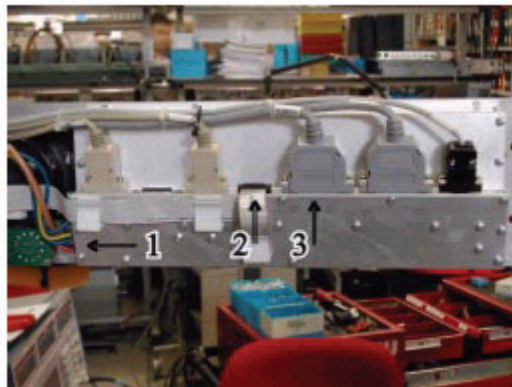
Figure 8-8 Services supply

8.7 Emergency CCU Board

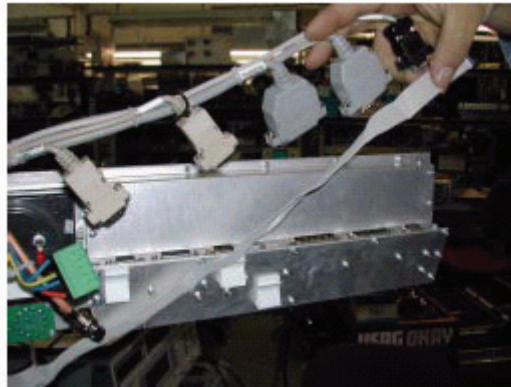
In the case the control unit presents a damage, it is possible assure the correct operation replacing, temporarily, the control panel with the card furnished together with the PJ10KPS-C.

To effect the substitution, execute the following instructions:

- 1) Switch-OFF the amplifier. Remove the screw on the left side of the LCD panel, open the panel and individualize the necessary connectors to the operation of the emergency card.



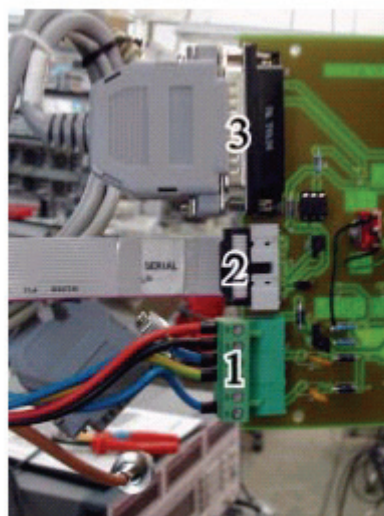
- 2) Disconnect all the cables connected to the unit control.



- 3) Unscrew the screws that fix the board to the rack and remove the panel from its place.

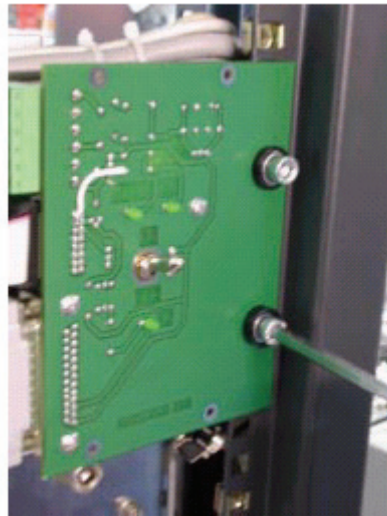


- 4) Connect the three connectors previously identified to the entries of the board, like represented in the photo.

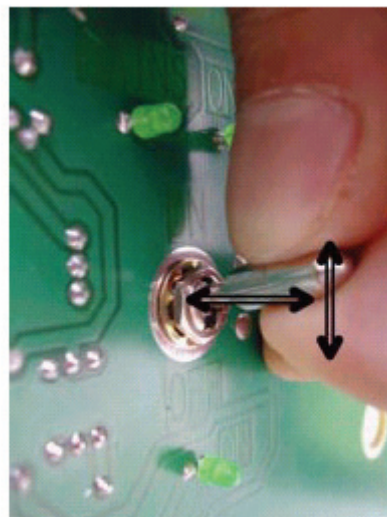


- 5) Fix the board to the rack, in the same position in which previously had fixed the central panel of control. Do attention to fix the side of the card from which the interrupter sticks

out toward the outside of the amplifier.

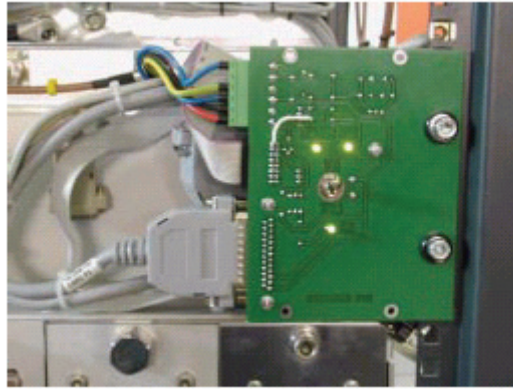


- 6) Switch-ON the apparatus with general switch and activate the operation of the board putting the interrupter on the ON position. The switch has built in way to avoid the accidental operating; throw the interrupter toward the outside, go on the desired position and release the interrupter.



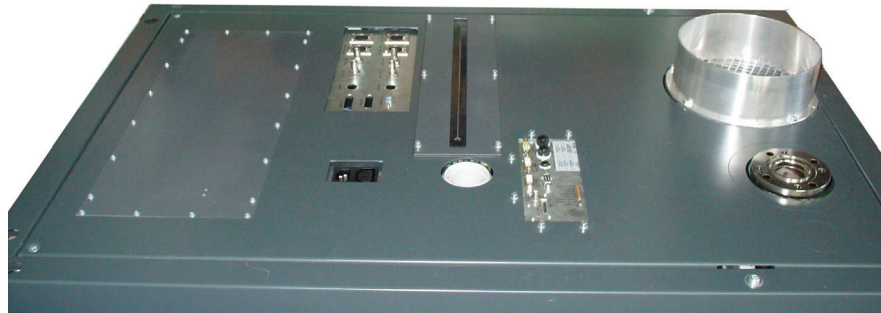
Now the emergency board is operative.

When be used the emergency board, the amplifier acts with the parameters previously adjusted (for example: the level of power). To modify the parameters is necessary use the unit control.



8.8 PJ10KPS-C Ventilation

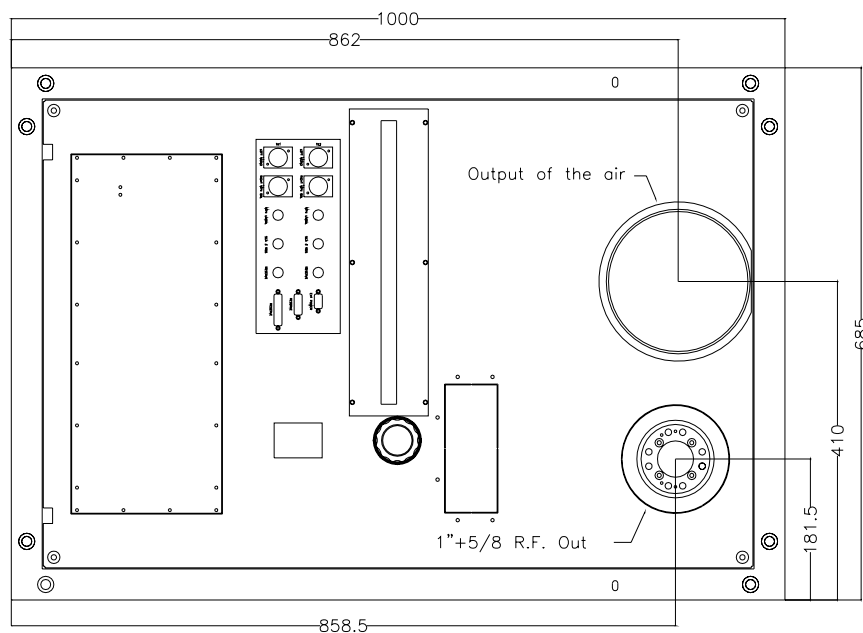
Each amplifier PJ10KPS-C has furnished of an internal fan, of input and output of the air.

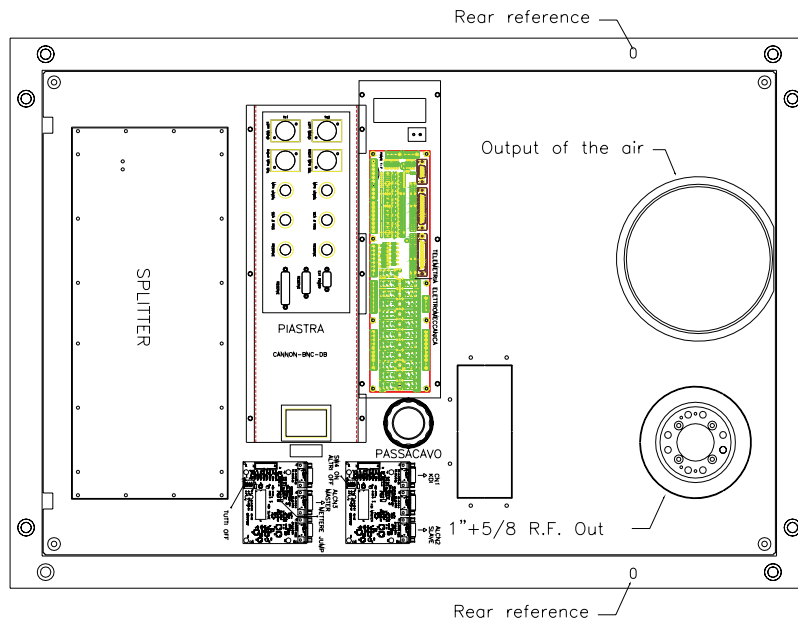


View of the chimney air inlet

The current of output air is equal to 600 m³/h.

The input hole of the air is situated on the back cover of the rack, but on demand is possible have an ulterior chimney inlet air on the top cover of the rack.





Representation of the air outlet hole location and the additional

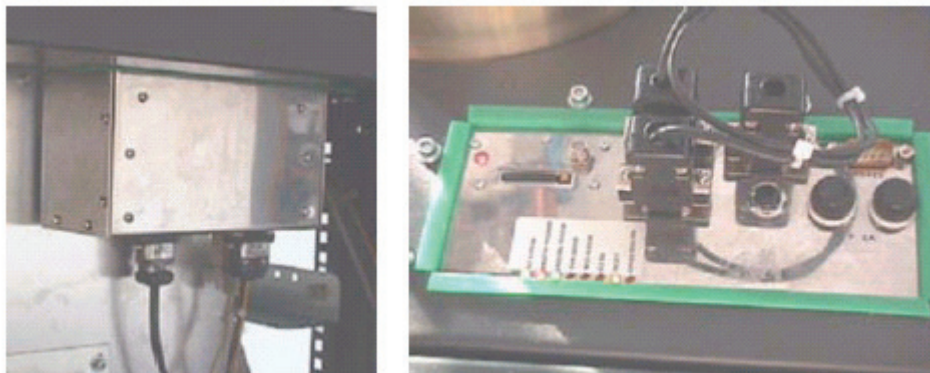
9 Digital Telemetry (TLC5KPS)

9.1 Foreword

R.V.R. Elettronica's plug-in series transmitters, like TX5KPS, may be optionally fitted with the TLC5KPS, a telemetry device that enables the user to remotely check all the machine's working parameters and control some of them, and provides the transmitter with the ability to trigger "alarms" when problems arise while the transmitter is on air, possibly sending GSM Short Messages (SMS) to the maintainer's cellular phone or to any other number stored in the machine's memory.

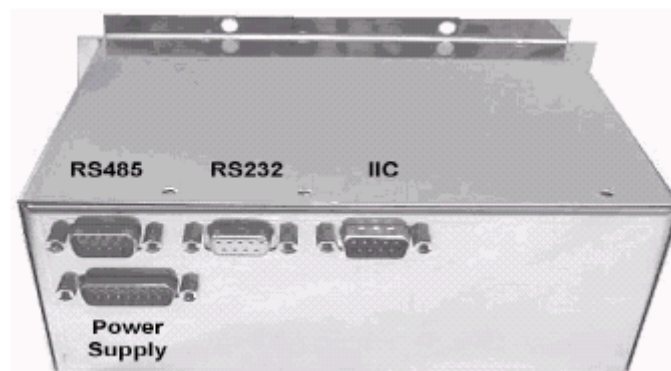
9.2 Installation

The TLC5KPS is installed in the rear part of the transmitter's rack, near to the low-pass filter and the RF output connector.

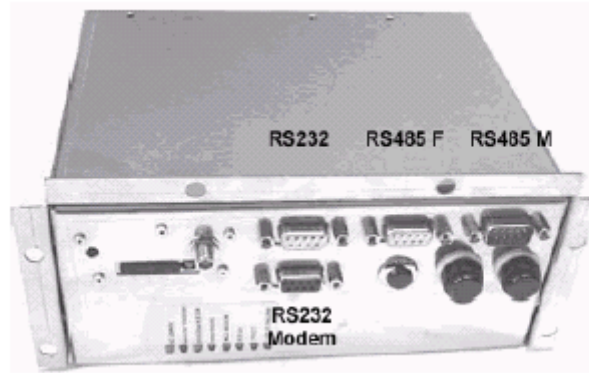


9.2.1 Connection

The bottom side of the TLC5KPS contains the following connectors:

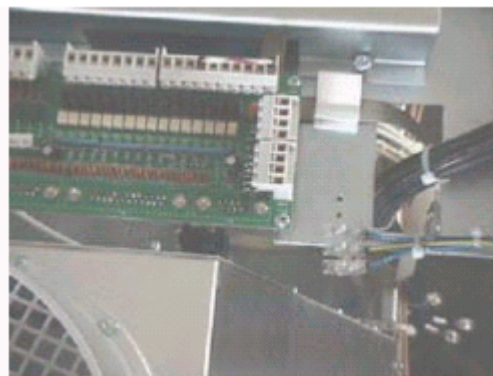
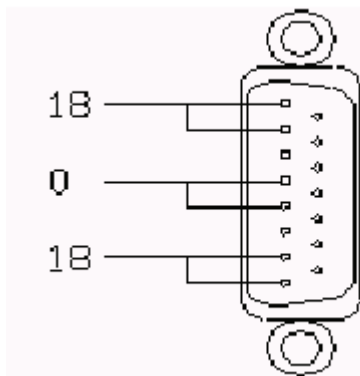


The upper side contains the following connectors:

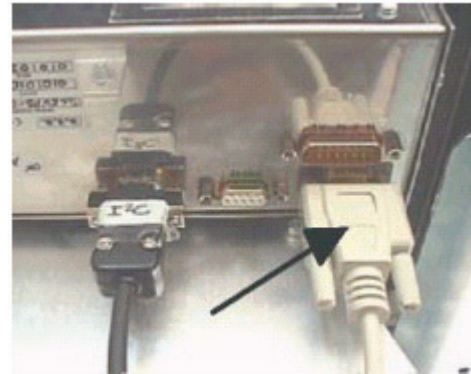
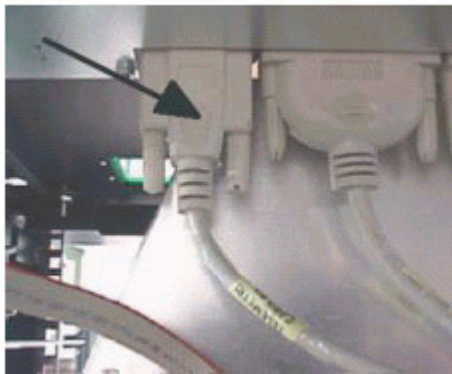


The following connections should be performed on the bottom side:

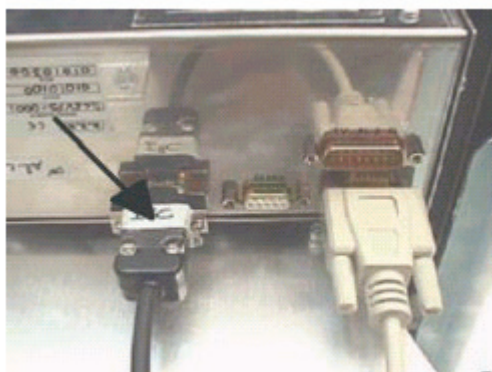
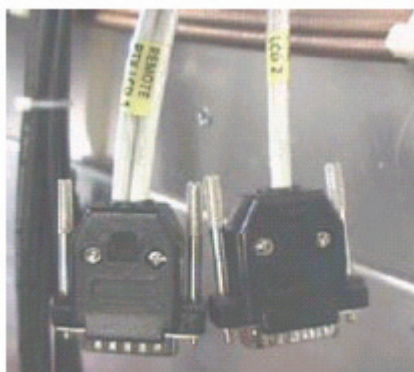
- **DB15 male**, providing the power supply (18 V, 0, 18 V AC). The power supply is provided through the terminal block of the parallel interface of the amplifier.

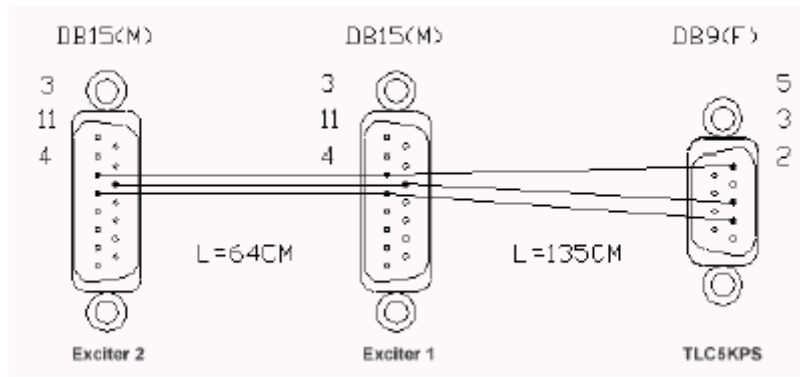


- **DB9 RS485** coming from the parallel interface



- **DB9 I2C** connected to the exciters

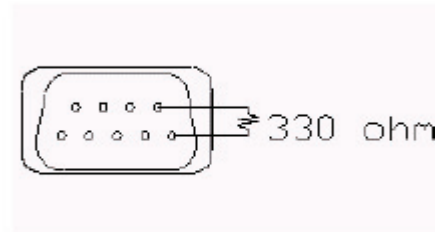
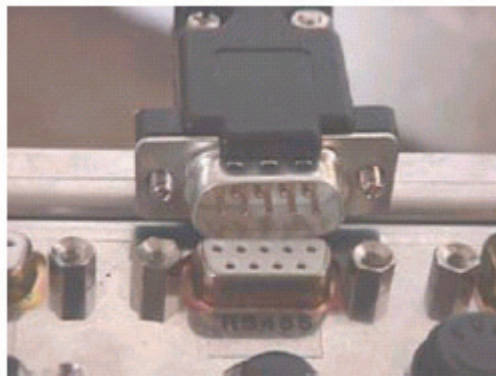




- **DB9 RS232** not connected

On the upper side:

- **RS485 Connector** with termination resistor. This connection is required, or malfunctioning in the communications will likely happen! The connector contains a 330 Ohm resistor between PINs 1 and 6.



- **SMA connector** for the GSM antenna. The GSM modem can be directly installed inside the TLC5KPS: in this way the machine will provide the named SMA connector, the status LEDs of the modem and the slot for the GSM SIM card.

Please note that an external and possibly directive antenna for the GSM is always suggested, to provide the GSM modem with a good signal and ensure reliable data communications.

Please note that to fully deploy the features of this telemetry system, the you will need to sign a contract with a GSM service provider including DATA COMMUNICATIONS.

9.2.2 Devices settings

The use of the telemetry system requires the correct setting of the address in the connected pieces of equipment, since they communicate on a shared bus.

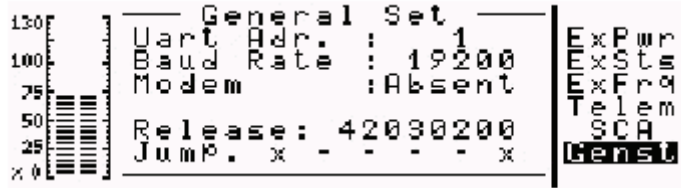
9.2.2.1 Exciters

Set the Uart address of exciter 1 to "1", exciter 2 to "2"

To perform this setting, from the main menu click on "ADMIN", then select Genst from the navigation bar, select "Uart Adr." on the General Set menu and change it to "1" for the exciter 1, "2" for the exciter 2.

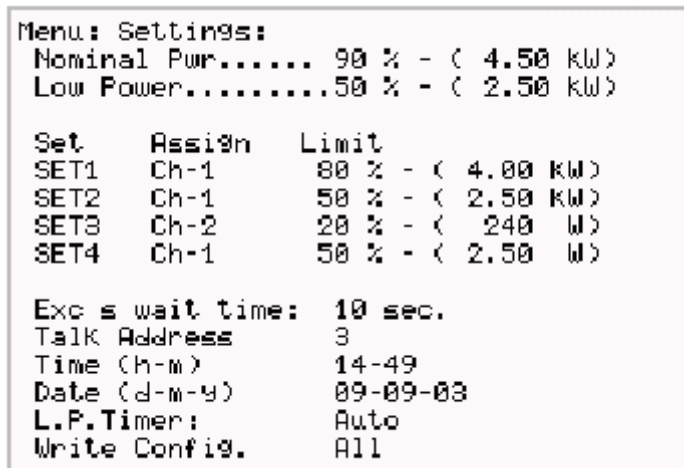
9.2.2.2 Amplifier

Set the "Talk address" parameter to "3".



To perform this setting, press the button ESC on the Control Unit of the PJ10KPS-C. You will be presented with the “Menu Select” screenful. With the UP and DOWN buttons, select the line “Settings” and press the OK button.

In this menu, select the line “Talk Address” and press OK. With the UP and DOWN buttons change the parameter to “3” and press OK.



9.2.3 Installing and configuring the PC software

Setting up the telemetry is best performed directly connecting a personal computer to the TLC5KPS.

You will need:

- A PC running on Windows 98 or newer (the software has been tested with 98, NT, 2000 and XP)
- The “Telecon 32bit” CD ROM, provided with the machine
- DB9 pin-to-pin cable long enough to link the PC to the TLC5KPS

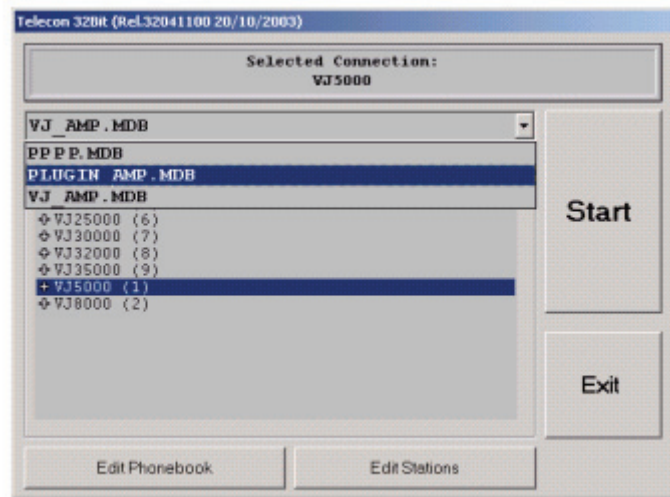
Insert the CDROM in the PC, browse and executethe program setup_telecon.exe. Follow the instructions on screen to install the software on your PC.

Please note that if you already have an installed version of the Telecon32bit software, the new software will just upgrade it and will not affect you installed station database.

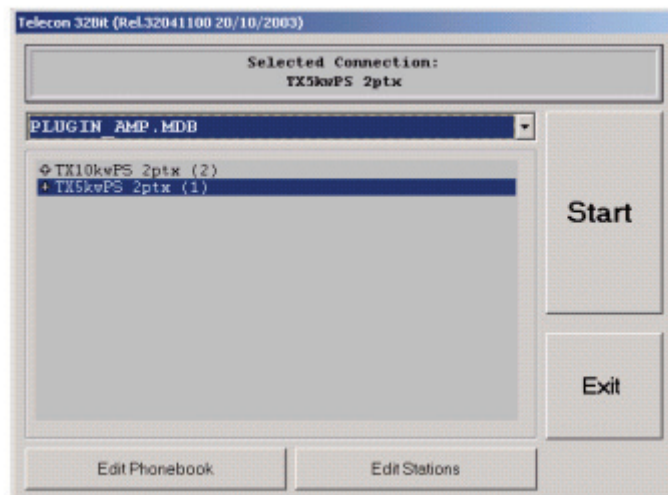
Launch the Telecon program: Start -> Programs -> Telecon 32bit

You will be presented with the database selection screen.

On the Database combobox (the top line), selet the PLUGIN_AMP.MDB database.

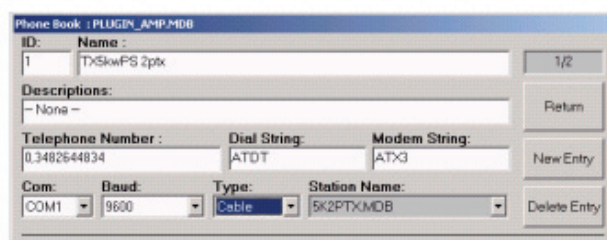


Then select the station TX10KWPS 2PTX station and click on “Edit Phonebook”.



The screenful the software will show allows you to configure all the aspects of the transmitter, like kind of modem, telephone number and so on.

Configure this screenful as shown in the following figure, that is select “Cable” and the COM port you will use.



Click Return.

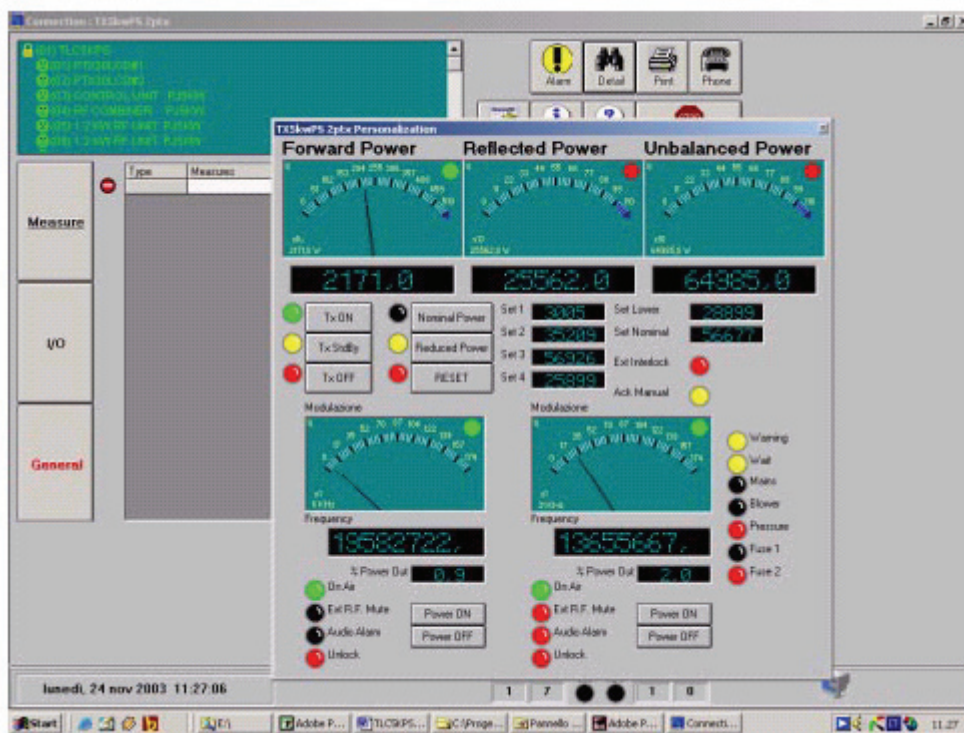
Connect the DB9 cable between the PC and the TLC5KPS telemetry unit.

Click on Start. The PC will perform the connection with the transmitter and then will show the program screen and the “Detail screen” already opened.

The TLC5KPS automatically detects the type of connection, that is direct connection, GSM modem or PSTN modem.

After 1-2 minutes, the Telecon software will have acquired all the data of the modules.

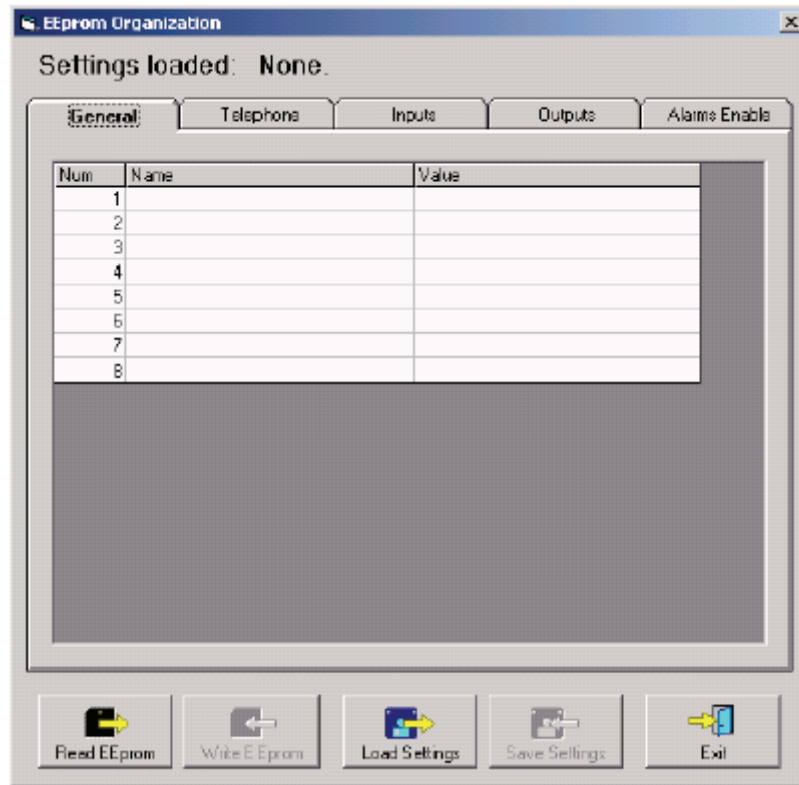
Note the smileys on the bottom blinking red and green to show ongoing communications.



Double-click on TLCKPS. Then select EEprom and click on it.



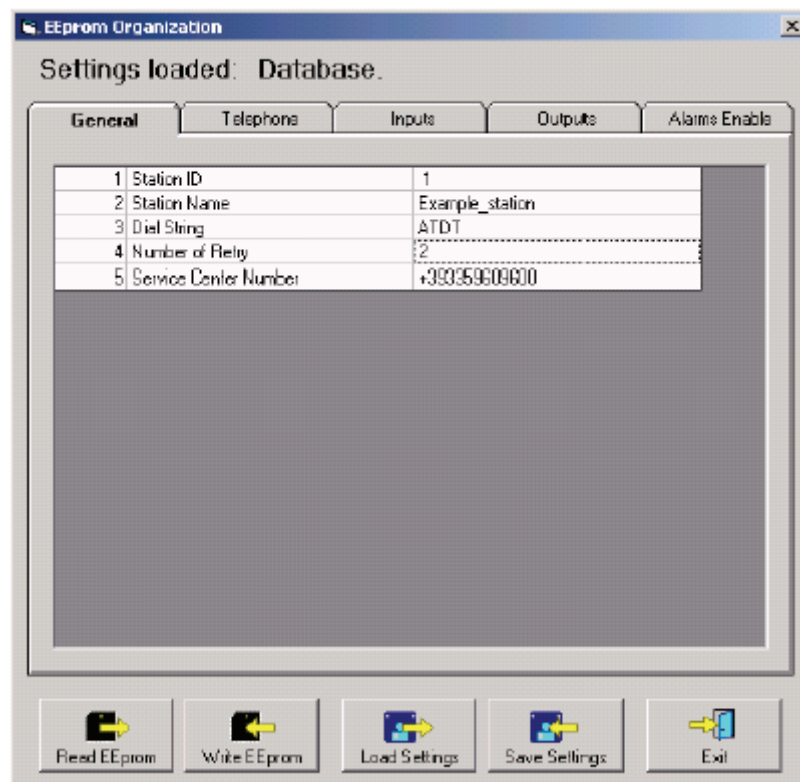
You will now see the EEprom organization window:



Click on READ EEPROM and then OK. Note blue progress bar indicating reading is in progress.

When the EEPROM reading will have been completed, the button WRITE EEPROM will also be available.

Click on the tab "General" and do the following settings (for example):

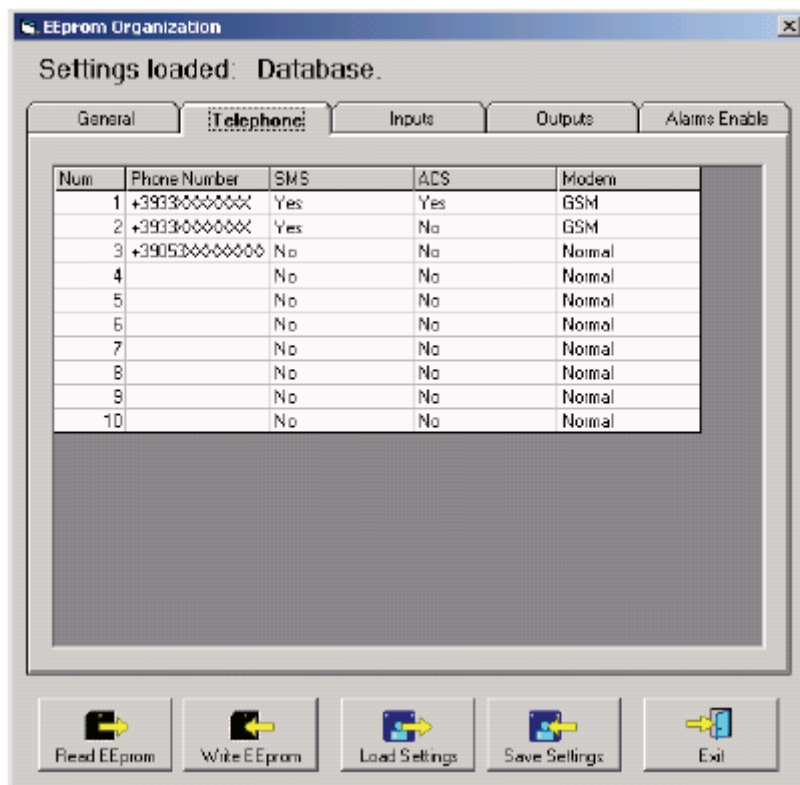


- Station ID** ID for addressing purpose. Write if you only have 1
- Station Name** Mnemonic name of the station, like place or frequency
- Dial String** Normally, ATDT
- Number of Retry** Number of messages to send. We suggest to set this value to at least 2, in case of problems with the SMS Service Centre.

Then click on Telephone and fill it with the telephone numbers that will be known to the station. Yes or No in the SMS column specifies whether the number will receive a SMS in case of alarms, while the column ACS determines the numbers entitled to send commands via SMS to the station, avoiding interferences from inexperienced operators.

Finally, specify the kind of modem the station shall send the alarm to, so that it will determine whether to send a SMS or place a normal telephone call.

At this point, click on WRITE SETTINGS and then WRITE EEPROM: you will see the blue progress bar indicating the software is loading into the TLC5KPS.



The display of the control unit of the amplifier will show in the menu “MODEM” (firmware version 3.9 and up) the stored telephone numbers, the SMS service center number, the modem status and the kind of connection.

```

Menu: Modem Type: Auto
I.D. : 01 - Name: Example_station
S.C.N. : +1234567890
Info : NETWORKPROV Dial: ATDT
Phone : +2345678901
Phone : +3456789012
Phone : +4567890123
Phone :
Phone :
Phone :
Phone :
Phone :
Phone :
Level : -65 dB Status: RXMSG
Retry : 2/5
    
```

Wait about 2 or 3 minutes and check on the display or on the LED “MODEM PRESENT” on

the top of the rack the correct update of the firmware configuration.

On the display you will read on the display the signal level and the status of the modem. Please note that it could be necessary to exit and reenter in the Modem menu (push ESC) to refresh it.

9.2.4 Alarms and commands

9.2.4.1 Alarms sent by the transmitter

1. Forward Power
2. Reflected Power
3. Unbalanced Pwr
4. No Audio PTX1
5. No Audio PTX2
6. Mains Fault
7. Over temp 1
8. Over temp 2
9. Fuse1 PS
10. Fuse2 PS
11. Blower Fault
12. Fault Mod 1
13. Fault Mod 2
14. Fault Mod 3
15. Fault Mod 4
16. Fault Mod 5
17. Fault Mod 6 (only 10Kw)
18. Fault Mod 7 (only 10Kw)
19. Fault Mod 8 (only 10Kw)
20. Fault Mod 9 (only 10Kw)
21. Fault Mod 10 (only 10Kw)
22. Pressure Fault
23. Mains OK

9.2.4.2 SMS commands available

The commands that can be sent to the transmitter using SMS messages are the following:

Command	Reply	Description
INFO	Station: "station name" ID: "ID number" FWD: "value" RFL: "value" UNBAL: "value" TX On (or TX Off or TX StdB)- Low Power / Nom Power Audio Present / Audio Absent Alarm Present / Alarm Absent	Information about the transmitter's status
TXON	Station: "station name" ID: "ID number" TX is On -	Switching on the transmitter
TXOFF	Station: "station name" ID: "ID number" TX is Off	Switching off the transmitter
LOWPWR	Station: "station name" ID: "ID number" LowPwr OK-	Low Power setting
NOMPWR	Station: "station name" ID: "ID number" NomPwr OK-	Nominal Power setting
ALARM	Station: "station name" ID: "ID number" Alarm: "list of the alarms in memory"	List of the alarms in memory
RESET	Station: "station name" ID: "ID number" ALARM RESET OK-	Resetting the alarms in memory
RESMOD	- nothing -	Reset of the telemetry and modem restart

The Alarms for the RF power falling under a certain level and for the reflected power are connected to the Settings menu. Remember to adjust SET 1 SET2 and SET 3 in this menu to suit your need.

```

Menu: Settings:
Nominal Pwr..... 90 % - ( 4.50 kW)
Low Power.....50 % - ( 2.50 kW)

Set   Assign  Limit
SET1  Ch-1     80 % - ( 4.00 kW)
SET2  Ch-1     50 % - ( 2.50 kW)
SET3  Ch-2     20 % - ( 240 W)
SET4  Ch-1     50 % - ( 2.50 W)

Exc s wait time: 10 sec.
Talk Address     3
Time (h-m)       14-49
Date (d-m-y)     09-09-03
L.P.Timer:       Auto
Write Config.    All
    
```

When all of these parameters have been finally configured, put the selector on the control panel of the control unit on the "Remote" position. The yellow "LOCAL" led will go off and the green led will go on. We suggest at this point to do some tests to verify the functionality of the system.

9.3 Technical details

9.3.1 Modules mapping

9.3.1.1 Control Unit

Configuration data Block

0x00	ID	Device ID
0x01	RH	Hardware Release
0x02	RS	Software Release
0x03	In_Ana_Tot	Analog input number = 2
0x04	Out_Ana_Tot	Analog output number = 5
0x05	In_Dig_Tot	Digital input number = 32
0x06	Out_Dig_Tot	Digital output number = 32
0x07	Gen_Tot	General number = 3

Analog input data block

0x08	INANA0	Input Power
0x09	INANA1	Load Power

Analog output data block

0x0A	OUTANA0	RF combiner output power
0x0B	OUTANA1	RF combiner reflected power
0x0C	OUTANA2	Air temperature
0x0D	OUTANA3	Power supply voltage
0x0E	OUTANA4	Efficiency

Digital input data block

0x0F	INDIG0-15	Bit0: Ext Interlock Bit1: Aux Interlock Bit2: StdBy-In Bit3: Service Request Bit4: Local / Remote Bit5: Manual / Auto exchange exciter Bit6: Low Power Bit7: Nominal Power Bit8: Fault Exc 1 Bit9: Fault Exc 2 Bit10: Manual Exchange
------	-----------	---

Digital output data block

0x11	OUTDIG0-15	Bit0: Fault Bit1: Wait Bit2: Warning Bit3: Audio Alarm Bit8: Ack On Bit9: Ack Std By Bit10: Ack Off Bit11: Ack Low Power Bit12: Ack Nominal Power Bit13: Ack Change Exciter Bit14: Ack Manual Exchange
0x12	OUTDIG0-15	Bit0: On/Off Bit1: Stand By Bit2: Backlight Bit3: Relays Exciter Bit4: Mute Exciter 1 Bit5: Mute Exciter 2 Bit6: On/Off Exciter Bit8: Ack Res1 Bit9: Ack Res2 Bit10: Ack Res3 Bit11: Ack Res4

9.3.1.2 Hybrid Coupler

Configuration data Block		
0x00	ID	Device ID
0x01	RH	Hardware Release
0x02	RS	Software Release
0x03	In_Ana_Tot	Analog input number = 10
0x04	Out_Ana_Tot	Analog output number = 2
0x05	In_Dig_Tot	Digital input number = 16
0x06	Out_Dig_Tot	Digital output number = 16
0x07	Gen_Tot	General number = 3
Analog input data block		
0x08	INANA0	Forward Power
0x09	INANA1	Reflected Power
0x0A	INANA2	Input Power
0x0B	INANA3	Load Power
0x0C	INANA4	K.D.I. Temperature
0x0D	INANA5	Unbalanced Power
0x0E	INANA6	Air Temperature
0x0F	INANA7	External FWD Power
0x10	INANA8	External RFL Power
0x11	INANA9	External UNB Power
Analog output data block		
0x12	OUTANA0	Reserved.
0x13	OUTANA1	Reserved.
Digital input data block		
0x14	INDIG0-15	Bit0: On/Off Bit1: Std By Bit8: Over Temp.
Digital output data block		
0x15	OUTDIG0-15	Bit4: Std By Bit5: Sqr Bit8: Fan Bit12: Set1 Bit13: Set2 Bit14: Set3 Bit15: Set4

9.3.1.3 1.2 kW R.F. Unit

Configuration data Block		
0x00	ID	Device ID
0x01	RH	Hardware Release
0x02	RS	Software Release
0x03	In_Ana_Tot	Analog input number = 11
0x04	Out_Ana_Tot	Analog output number = 1
0x05	In_Dig_Tot	Digital input number = 16
0x06	Out_Dig_Tot	Digital output number = 16
0x07	Gen_Tot	General number = 3
Analog input data block		
0x08	INANA0	Forward Power
0x09	INANA1	Reflected Power
0x0A	INANA2	Input Power
0x0B	INANA3	Supply Voltage
0x0C	INANA4	Bias Voltage
0x0D	INANA5	Module Temperature
0x0E	INANA6	Diriver Current
0x0F	INANA7	Mosfet 1 Current
0x10	INANA8	Mosfet 2 Current
0x11	INANA9	Mosfet 3 Current
0x12	INANA10	Mosfet 4 Current
Analog output data block		
0x13	OUTANA0	Foldback
Digital input data block		
0x14	INDIG0-15	Bit0: On/Off Bit3: Std-By-In Bit8: Over Temperature Bit11: State of Fuse
Digital output data block		
0x15	OUTDIG0-15	Bit4: StandBy Bit5: Sqr Bit8: Led Red Bit9: Led Orange Bit10: Led Green

9.3.1.4 Power Supply

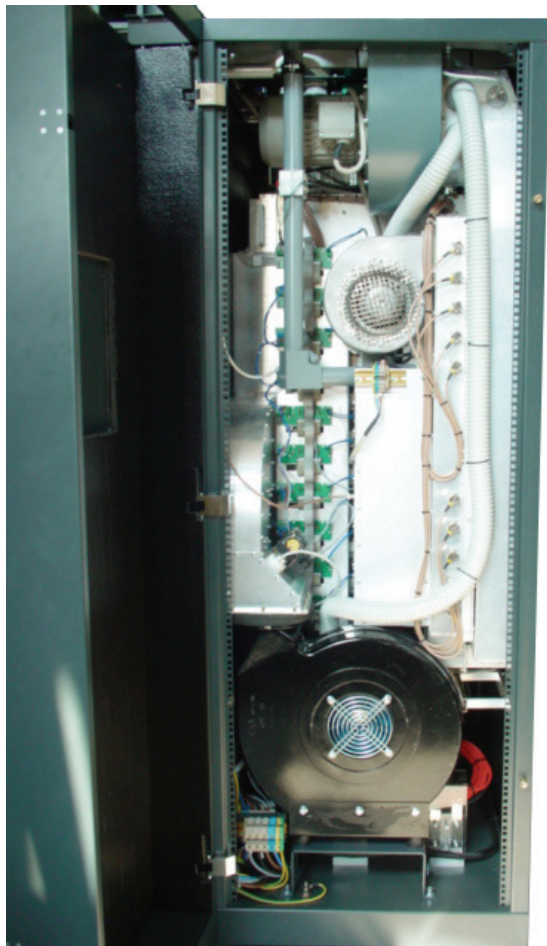
Configuration data Block		
0x00	ID	Device ID
0x01	RH	Hardware Release
0x02	RS	Software Release
0x03	In_Ana_Tot	Analog input number = 2
0x04	Out_Ana_Tot	Analog output number = 0
0x05	In_Dig_Tot	Digital input number = 16
0x06	Out_Dig_Tot	Digital output number = 16
0x07	Gen_Tot	General number = 3
Analog input data block		
0x08	INANA0	Bus Volt
0x09	INANA1	Temperature
Analog output data block		
--	--	--
Digital input data block		
0x0A	INDIG0-15	Bit0: On/Off Bit1: StdBy-In Bit3: Mains Fault Bit8: Over Temperature 1 Bit9: C.B. Bit10: Fuse 1 Bit11: Over Temperature 2 Bit12: Fuse 2 Bit13: Restart Safety Bit14: Pressure
Digital output data block		
0x0B	OUTDIG0-15	Bit4: StandBy Bit5: Sqr Bit8: Soft Start 1 Bit9: On 1 Bit10: Soft Start 2 Bit11: On 2 Bit15: Blower

9.3.2 Timings

Parameters	Time
Main routine timing	1 ms
Modem detection cycle	34 s
Modem init after restart	50 s
Modem init when detected	50 s
Maximum answer time after a command	5 min
Maximum complete measurement update	1,5 s
No TX reply timeout on the RS485 before setting "local status"	3 s
Display update time	1,5 s

10 Reference view

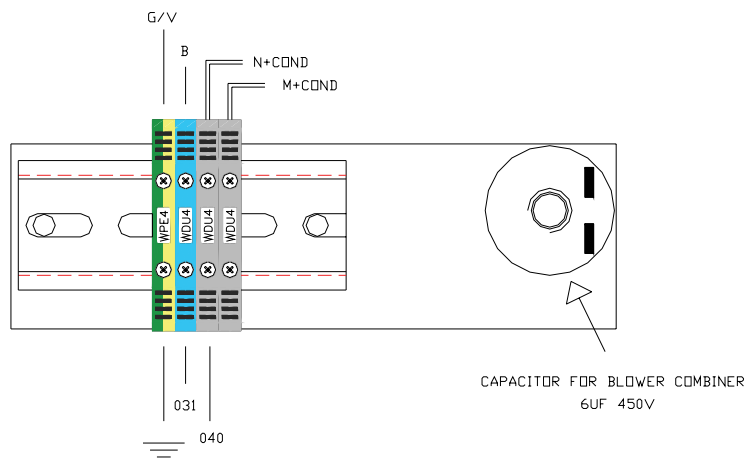
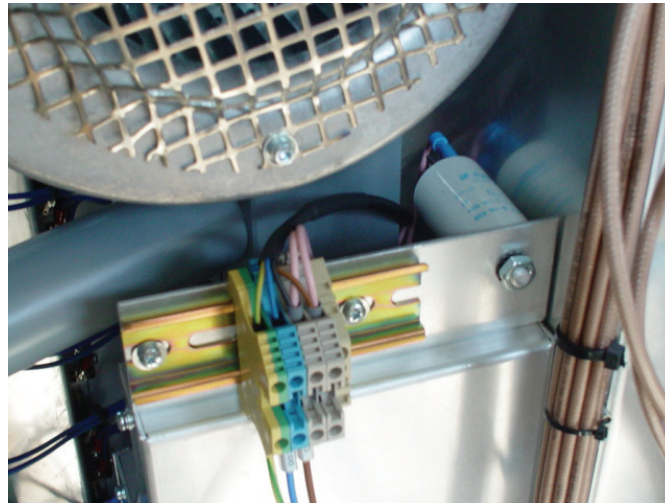
Rear view



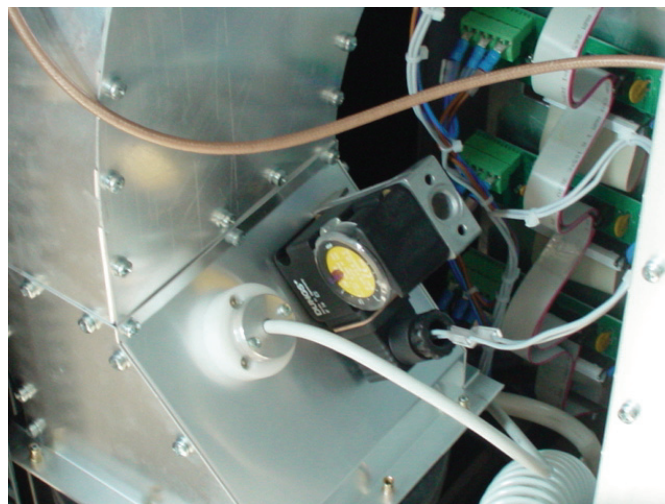
Side view



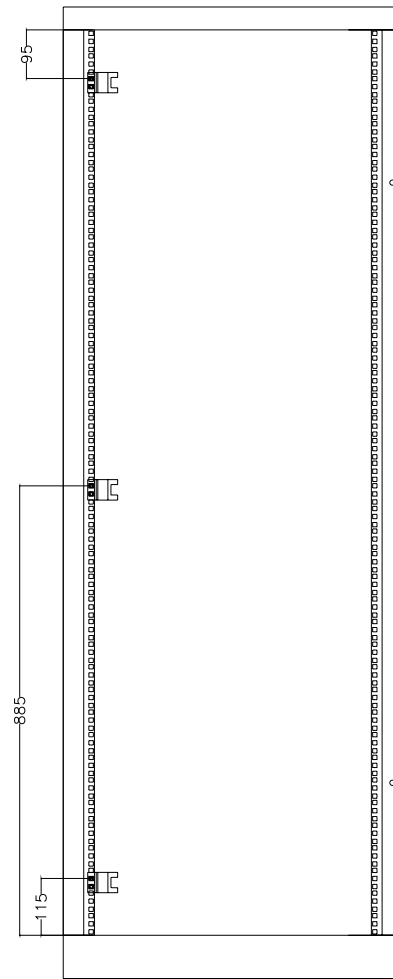
Clamps for blower Combiner



Pressure switch

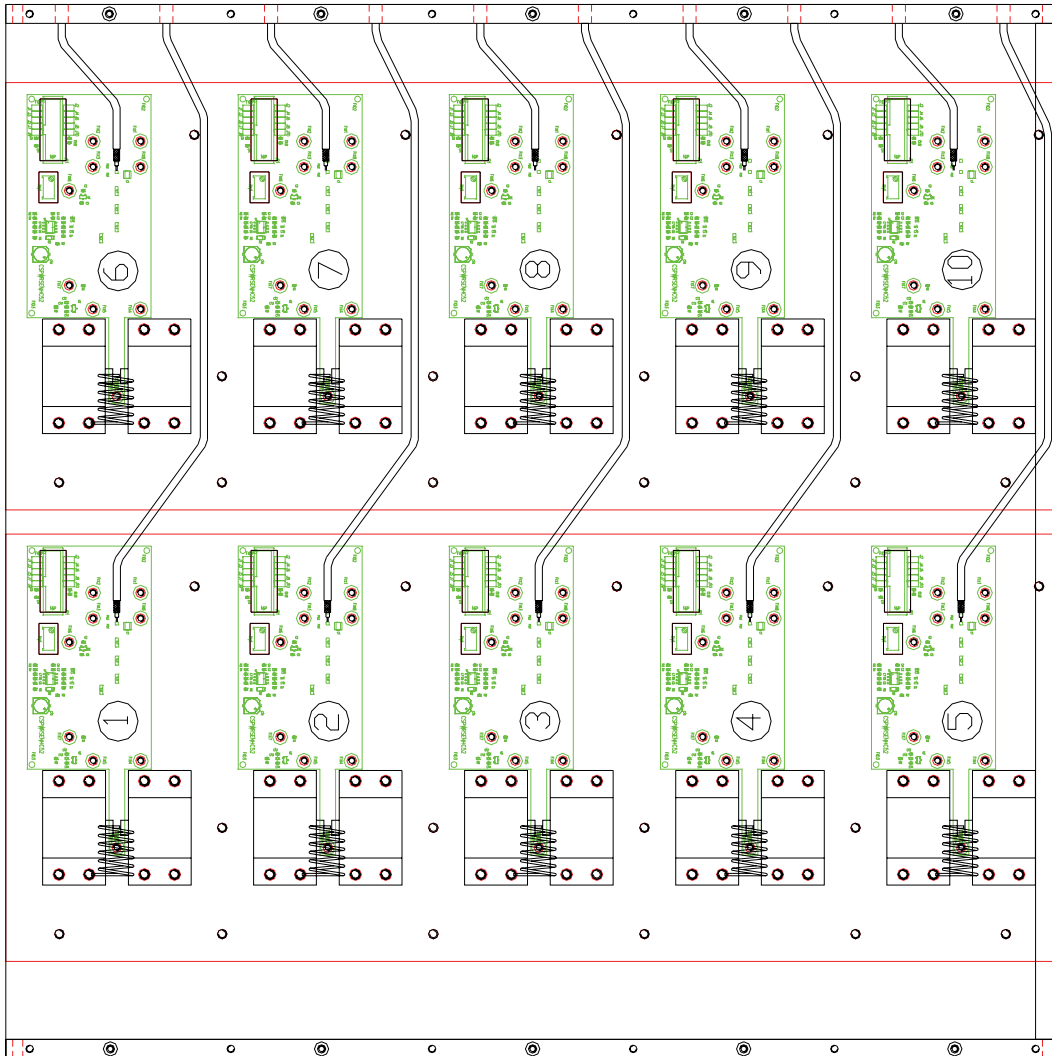


Assemblage soundproofing material box



KDI BLOCK

REAR VIEW INPUT CABLE



FRONT VIEW



TX10KPS – User & Technical Manual

© Copyright 2005

R.V.R. Elettronica S.p.A.

Via del Fonditore 2/2c – 40138 Bologna Italia

Telephone: +39 051 6010506

Fax: +39 051 6011104

E-mail: info@rvr.it

Web: www.rvr.it

All right reserved

Printed and bound in Italy. No part of this manual may be reproduced, memorized or transmitted in any form or by any means, electronic or mechanic, including photocopying, recording or by any information storage and retrieval system, without the permission of the copyright owner.