

PTX - LCD

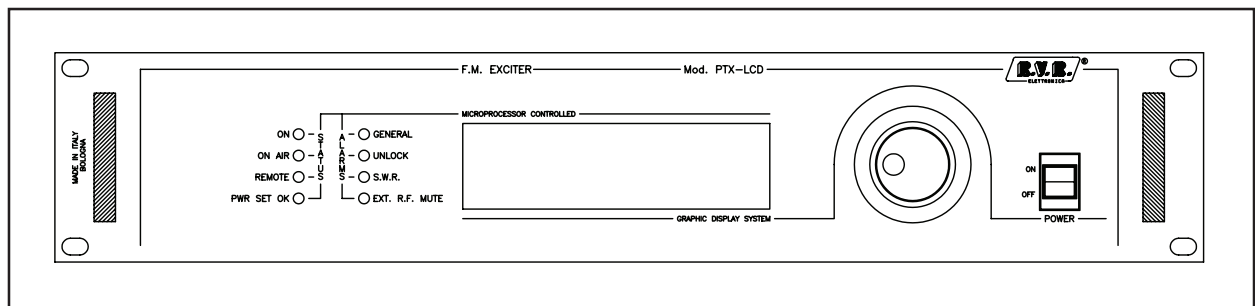

User Manual Volume 1

Manufactured by  Italy



Name File: capitoli_en.p65

Version: 3.2

Date: 24/07/2007

Revision History

Date	Version	Reason	Editor
07/05/04	0.0	New CPU 16 bit card	J. Berti
06/08/04	0.1	I.T.U. functionality addition	J. Berti
17/12/04	0.2	/GSM option addition and Software description upgrade	J. Berti
15/02/05	3.0	Upgraded Version	J. Berti
13/11/06	3.1	Remote Connector Description upgrade	J. Berti
24/07/07	3.2	Description upgrade of the jumper on panel card	J. Berti

PTX-LCD - User Manual
Version 3.2

© Copyright 1998 - 2007
R.V.R. Elettronica SpA
Via del Fonditore 2/2c - 40138 - Bologna (Italia)
Telephone: +39 051 6010506
Fax: +39 051 6011104
Email: info@rvr.it
Web: www.rvr.it

All rights reserved

Printed and bound in Italy. No part of this manual may be reproduced, memorized or transmitted in any form or by any means, electronic or mechanic, including photocopying, recording or by any information storage and retrieval system, without written permission of the copyright owner.

Notification of intended purpose and limitations of product use

This product is a FM transmitter intended for FM audio broadcasting. It utilises operating frequencies not harmonised in the intended countries of use. The user must obtain a license before using the product in intended country of use. Ensure respective country licensing requirements are complied with. Limitations of use can apply in respect of operating frequency, transmitter power and/or channel spacing.

Declaration of Conformity

Hereby, R.V.R. Elettronica SpA, declares that this FM transmitter is in compliance with the essential requirements and other relevant provisions of Directive 1999/5/EC.



Table of Contents

1. Preliminary Instructions	1
2. Warranty	1
3. First Aid	1
3.1 Treatment of electrical shocks	1
3.2 Treatment of electrical Burns	2
4. General Description	3
5. Quick Guide - Installation and Use	4
5.1 Using the encoder	4
5.2 Preparation	5
5.3 Operation	6
5.4 Calibration	7
6 External Description	10
6.1 Front Panel	10
6.2 Rear Panel	11
6.3 Rear Panel - AUDINP-DIG option	12
6.4 Rear Panel - TRDSP option	13
6.5 Rear Panel - GSM option	14
6.6 Connectors description	15
7. Operating System	18
7.1 Start-up	18
7.2 Operating System	18
8. System Status Enquiries	34
8.1 Local enquires	34
8.2 Remote enquiries using remote control software (Opt.)	34
8.3 Remote enquires using GSM modem+SMS	34
9. Remote Alarm Reporting and Control (Opt.)	36
9.1 Preparation	36
9.2 Remote Alarm Reporting Configuration	39
9.3 Remote Control	44
9.4 Internal Modem (Option /GSM)	45
10. Technical Specifications	47
10.1 Mechanical Specifications	47
10.2 Electric Specifications	47
11. Factory Settings	51
12. Module Identification and Access	53
12.1 Module identification	53
12.2 How to access modules	54

13. Operating principles	55
13.1 Power Supply	56
13.2 Audio mainboard	57
13.3 Audio Inputs	57
13.4 Coder	59
13.5 PLL/Driver card & VCO Card	60
13.6 Power amplifier	61
13.7 Panel Card	62
13.8 CPU card (16-bit)	63
13.9 Telemetry card "SLTELEM00001" (optional)	64
13.10 Telemetry card "SLTELEM00002" (optional)	66
13.11 AUDINP-DIG Card (option)	67
13.12 TRDSP card (optional)	70

1. Preliminary Instructions

This manual is written as a general guide for those having previous knowledge and experience with this kind of equipment, well conscious of the risks connected with the operation of electrical equipment.

It is not intended to contain a complete statement of all safety rules which should be observed by personnel in using this or other electronic equipment.

The installation, use and maintenance of this piece of equipment involve risks both for the personnel performing them and for the device itself, that shall be used only by trained personnel.

R.V.R. Elettronica SpA doesn't assume responsibility for injury or damage resulting from improper procedures or practices by untrained/unqualified personnel in the handling of this unit.

Please observe all local codes and fire protection standards in the operations of this unit.



WARNING: always disconnect power before opening covers or removing any part of this unit.

Please observe all local codes and fire protection standards in the operations of this unit.



WARNING: this device can irradiate radio frequency waves, and if it's not installed following the instructions contained in the manual and local regulations it could generate interferences in radio communications.

This is a "CLASS A" equipment. In a residential place this equipment can cause hash. In this case can be requested to user to take the necessary measures.

R.V.R. Elettronica SpA reserves the right to modify the design and/or the technical specifications of the product and this manual without notice.

2. Warranty

Any product of **R.V.R. Elettronica** is covered by a 24 (twenty-four) month warranty.

For components like tubes for power amplifiers, the original manufacturer's warranty applies.

R.V.R. Elettronica SpA extends to the original end-user purchaser all manufacturers warranties which are transferrable and all claims are to be made directly to R.V.R. per indicated procedures.

Warranty shall not include:

- 1 Re-shipment of the unit to R.V.R. for repair purposes;
- 2 Any unauthorized repair/modification;
- 3 Incidental/consequential damages as a result of any defect;
- 4 Nominal non-incidentual defects;
- 5 Re-shipment costs or insurance of the unit or replacement units/parts.

Any damage to the goods must be reported to the carrier in writing on the shipment receipt.

Any discrepancy or damage discovered subsequent to delivery, shall be reported to **R.V.R. Elettronica** within **5** (five) days from delivery date.

To claim your rights under this warranty, you should follow this procedure:

- 1 Contact the dealer or distributor where you purchased the unit. Describe the problem and, so that a possible easy solution can be detected.

Dealers and Distributors are supplied with all the information about problems that may occur and usually they can repair the unit quicker than what the manufacturer could do. Very often installing errors are discovered by dealers.

- 2 If your dealer cannot help you, contact **R.V.R. Elettronica** and explain the problem. If it is decided to return the unit to the factory, **R.V.R. Elettronica** will mail you a regular authorization with all the necessary instructions to send back the goods;
- 3 When you receive the authorization, you can return the unit. Pack it carefully for the shipment, preferably using the original packing and seal the package perfectly. The customer always assumes the risks of loss (i.e., R.V.R. is never responsible for damage or loss), until the package reaches R.V.R. premises. For this reason, we suggest you to insure the goods for the whole value. Shipment must be effected C.I.F. (PREPAID) to the address specified by R.V.R.'s service manager on the authorization



DO NOT RETURN UNITS WITHOUT OUR AUTHORIZATION AS THEY WILL BE REFUSED

- 4 Be sure to enclose a written technical report where mention all the problems found and a copy of your original invoice establishing the starting date of the warranty.

Replacement and warranty parts may be ordered from the following address. Be sure to include the equipment model and serial number as well as part description and part number.



R.V.R. Elettronica SpA
Via del Fonditore, 2/2c
40138 BOLOGNA
ITALY
Tel. +39 051 6010506

3. First Aid

The personnel employed in the installation, use and maintenance of the device, shall be familiar with theory and practice of first aid.

3.1 Treatment of electrical shocks

3.1.1 If the victim is not responsive

Follow the A-B-C's of basic life support.

- Place victim flat on his back on a hard surface.
- Open airway: lift up neck, push forehead back (**Figure 1**).

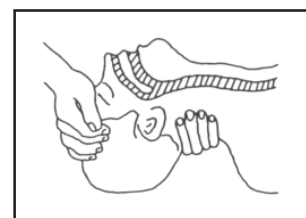

Figure 1

- clear out mouth if necessary and observe for breathing
- if not breathing, begin artificial breathing (**Figura 2**): tilt head, pinch nostrils, make airtight seal, four quick full breaths. Remember mouth to mouth resuscitation must be commenced as soon as possible.



Figura 2

- Check carotid pulse (**Figura 3**); if pulse is absent, begin artificial circulation (**Figura 4**) depressing sternum (**Figura 5**).



Figure 3

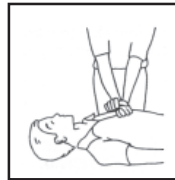

Figure 4

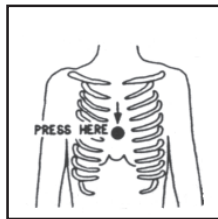

Figure 5

- In case of only one rescuer, 15 compressions alternated to two breaths.
- If there are two rescuers, the rythm shall be of one brath each 5 compressions.
- Do not interrupt the rythm of compressions when the second person is giving breath.
- Call for medical assistance as soon as possible.

3.1.2 If victim is responsive

- Keep them warm.
- Keep them as quiet as possible.
- Loosen their clothing (a reclining position is recommended).
- Call for medical help as soon as possible.

3.2 Treatment of electrical Burns

3.2.1 Extensive burned and broken skin

- Cover area with clean sheet or cloth.

- Do not break blisters, remove tissue, remove adhered particles of clothing, or apply any salve or ointment.
- Treat victim for shock as required.
- Arrange transportation to a hospital as quickly as possible.
- If arms or legs are affected keep them elevated.

If medical help will not be available within an hour and the victim is conscious and not vomiting, give him a weak solution of salt and soda: 1 level teaspoonful of salt and 1/2 level teaspoonful of baking soda to each quart of water (neither hot or cold).

Allow victim to sip slowly about 4 ounces (half a glass) over a period of 15 minutes.

Discontinue fluid if vomiting occurs.

DO NOT give alcohol.

3.2.2 Less severe burns

- Apply cool (not ice cold) compresses using the cleansed available cloth article.
- Do not break blisters, remove tissue, remove adhered particles of clothing, or apply salve or ointment.
- Apply clean dry dressing if necessary.
- Treat victim for shock as required.
- Arrange transportation to a hospital as quickly as possible.
- If arms or legs are affected keep them elevated.

4. General Description

The **PTX-LCD** is an FM exciter featuring a 19" RACK-mountable form factor. It uses an 87.5 to 108 MHz frequency band, with 10 kHz steps. Other frequency ranges are available on request.

The **PTX-LCD** output power ranges from 0 W up to 30, 60 or 100 W for the **PTX30LCD**, **PTX60LCD** and **PTX100LCD**, respectively.

The **PTX-LCD** is available in a version with incorporated stereo coder (identified by code "/S") or in a **MONO/MPX** version. The **MONO/MPX** model may be used for mono or stereo transmission using an external stereo coder.

User interface consists of a graphic liquid crystal display and a knob (encoder). This interface lets you view all parameters relating to machine operation and adjust settable parameters (e.g.: power level or operating frequency).

The exciter has been designed to easily integrate into complex transmission systems. To this end, it is capable of accepting data from, controlling or interacting with external equipments, such as amplifiers, switching units, relays or other exciters.

The **PTX-LCD** design is based on a modular concept: the different functions are performed by modules that are connected directly through male and female connectors or through flat cables terminated by connectors. This design facilitates maintenance and module replacement.

The **PTX-LCD** supports remote alarm monitoring by sending SMS alarm messages and receiving SMS commands through an external or integrated GSM modem (option /GSM).

Alarms can be activated for the following parameters:

- **PTX-LCD** output power (FWD);
- **PTX-LCD** reflected power (RFL);
- External forward power of an amplifier or coupler with protection card (E.FWD);
- External reflected power of an amplifier or coupler with protection card (E.RFL);
- Audio signal missing;
- MAINS failure (available when the **PTX-LCD** is connected to an UPS unit).
- up to 8 customised alarms can be programmed when the optional telemetry card is installed

The management software offers an intuitive user interface and runs on any PC in the WINDOWS™ environment.

5. Quick Guide - Installation and Use

This chapter gives a concise view of the points that are necessary for the installation of the device. If any item is not completely clear, for example when you use the exciter for the first time, we strongly suggest to read throughly the manual and the description of the operating system.

5.1 Using the encoder

The interaction between the user and the exciter's control software is performed using the encoder (fig. 5.1).

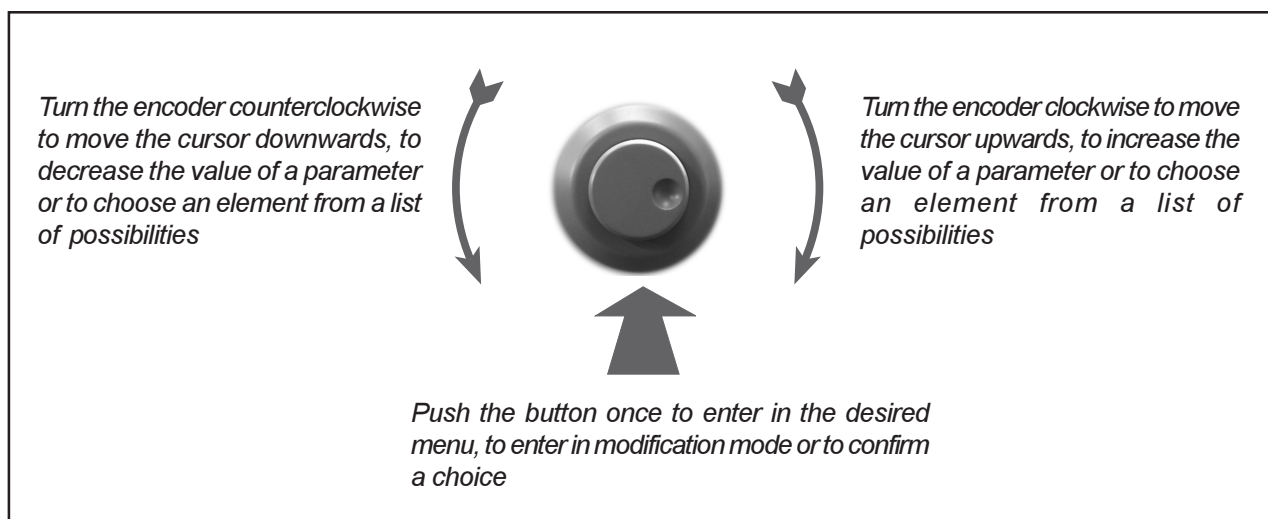

Figure 5-1

The operations that can be performed on the encoder are:

- **rotation:** moves the cursor shown on the display; if you turn the encoder to the left (counterclockwise), the cursor moves downwards, if you turn it right the cursor moves upwards; it also permits to increase or diminish the parameters (turning the encoder left diminishes the parameter, turning it right increases it) or to select an item form a list of options.
- **pushing:** push the button once when the cursor is on the name of a menu to enter in that menu, push it when the corsor is on the name of a parameter to enter in modification mod (the corsor starts blinking); after the modification of a parameter, push the button to save the new value.

After having modified the value of a parameter, the cursor goes on blinking for approximately 30 seconds, waiting for confirmation from the user. If the user doesn't confirm the new value (i.e., the button is not pressed), the device emits a sound to indicate that no modification has been saved; the cursor stops blinking and remains on the selected parameter.

5.2 Preparation

Unpack the transmitter and before any other operation check the unit for any shipping damage and check that all the controls and connectors on the front and rear panels are in good conditions.

Check the mains voltage selector on the rear panel: the selected value is indicated by an arrow. If required, extract the selector block levering with a little screwdriver (Fig. 5-2). Rotate the block until the correct printed value corresponds with the arrow, then reinsert it.

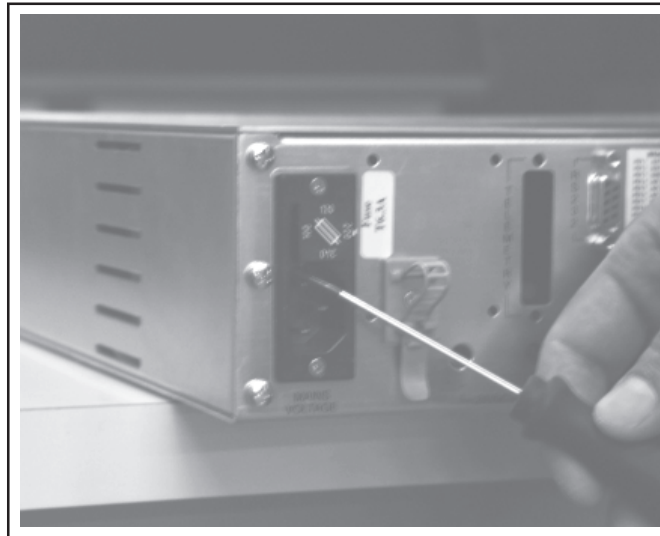

Figure 5-2

If it has been necessary to change voltage, check the fuse value. The required values are the following:

PTX30-LCD	220-240 Volt - 3,16 A (6x30) 110-120 Volt - 6,30 A (6x30)
PTX60-LCD	220-240 Volt - 6,30 A (6x30) 110-120 Volt - 10,0 A (6x30)
PTX100-LCD	220-240 Volt - 6,30 A (6x30) 110-120 Volt - 10,0 A (6x30)

It is also possible to check the integrity of the RF amplifier section fuse: Its value is 4A for the **PTX30-LCD** version and 8A for the **PTX60-LCD** and **PTX100-LCD** versions.

Verify that the mains switch on the front panel of the unit is on the OFF position.

Connect to the RF output of the exciter a proper load (a dummy load with suitable dissipation power, an antenna, a final amplifier or a combiner).



NOTE: When you connect the **PTX-LCD** to other devices, it is necessary to strictly follow the instructions given by the respective manufacturers, to avoid damages or danger situations.

Connect the mains cable to the plug on the rear of the exciter.



NOTE: This device shall be correctly connected to ground.
Correct grounding is essential both for safety and to reach the rated performances.

Connect your source audio (for example the mixer or STL output) to the suitable input connector. Depending on the version, the **PTX-LCD** offers a number of input choices, L+R, MPX or even digital; see the connectors description for details.

5.3 Operation

Switch on the exciter with the mains switch on the front panel.

All the STATUS and ALARMS leds are lit on to permit the verification of their good working status. The display than shows some information regarding the exciter.

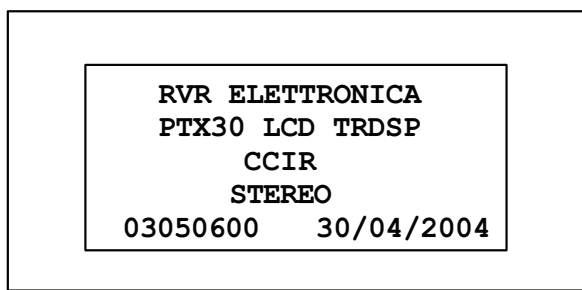

After a few seconds, an intermittent beep and a display message prompt the user to push the button if operating parameters are not acceptable.

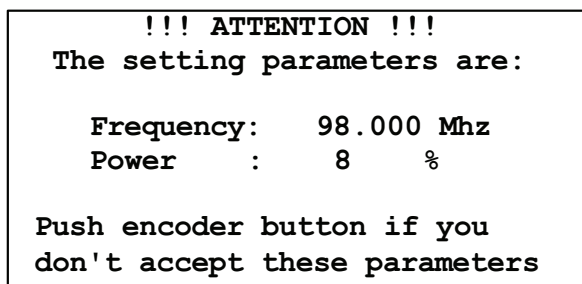

Pushing the button places the transmitter in standby mode, which provides full operation, but disables RF power output.

If the button is not pushed, the start-up sequence will continue.

The transmitter stores set parameters in a non volatile memory so that the correct configuration is retained upon power-off.

When settings are not correct, as may be the case on first power-on, or need to be changed for some reason before beginning transmission, the transmitter may be placed in standby mode as mentioned above.

This is only necessary when you wish to change machine settings before beginning transmission.

The **PTX-LCD** menu system (see Section 7) enables the user to control all operating parameters of the machine.

Before enabling exciter power output, check the following key parameters and adjust as required:

- frequency
- power
- audio input level
- audio input impedance
- preemphasis
- audio input type (depending on version, MONO or MPX; or MONO, MPX_U, MPX_B, STEREO)
- if in STEREO mode, ensure that pilot tone is active

If RF power output was disabled, you may now enable it from the **MAIN** menu as follows: select the first item and change setting from OFF to ON.

The RF power output of the **PTX-LCD** may be disabled from the main menu at any time.

During machine operation, all available parameters can be viewed or edited using the menu system.

5.4 Calibration

The **PTX-LCD** trimmers can be accessed from the rear panel and can be adjusted by the user. There are two EXT AGC (FWD and RFL) trimmers and the LEVELADJ trimmers (Fig. 6-2 [16]).

The LEVEL ADJ trimmers are used to control modulation levels to the matching inputs. Audio input levels are adjusted via software in 1 dB steps and the trimmers are used for fine tuning.

For SCA input levels, only trimmer adjustment is available.

The EXT AGC trimmers enable the user to limit exciter output power according to the levels reached by two analogue quantities acquired through the Remote connector.

The two trimmers use the same mode of operation: EXT AGC - FWD is connected to pin 10 of the Remote connector, whereas EXT AGC-RFL is connected to pin 2. If voltage at either of the pins exceeds the threshold set at the matching trimmer, exciter output power is reduced until the monitored quantity drops below the set limit.

These trimmers are very useful when the exciter is part of a transmission system. For example, assuming that the **PTX-LCD** is connected to a power amplifier, a proportional signal may be linked to amplifier output power at pin 10 and another proportional signal may be linked to reflected power at pin 2. This way, power is kept steady at varying operating frequencies even though amplifier gain is variable and reflected power limitation is achieved for the whole system without triggering amplifier protection equipments.

The calibration procedure for the EXT AGC trimmers of **PTX-LCD** in a configuration with power amplifier is described below.

Perform the connections shown in figure 5-3. The cable to connect the two equipments is available from R.V.R. Elettronica on request, or the user may ask a skilled technician to provide a cable to match the pinout of the amplifier used.

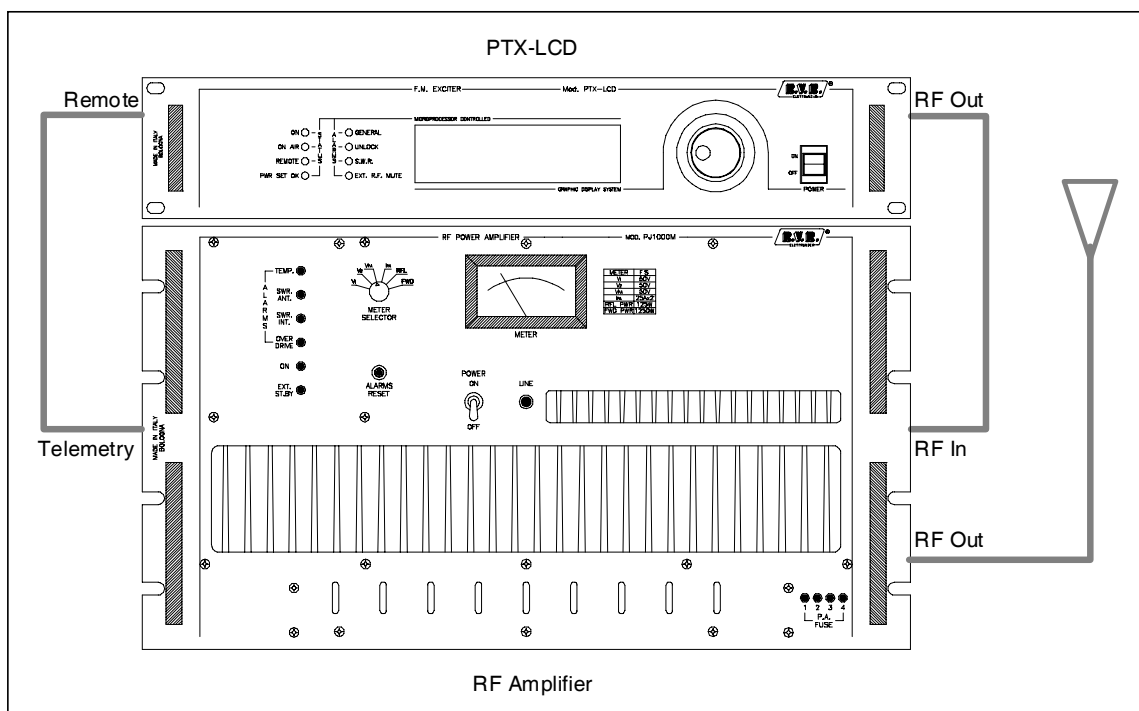

Figure 5-3

Switch on amplifier and exciter set to minimum power.

Turn both trimmers fully anticlockwise.

Gradually increase exciter output power until the forward power reading on the amplifier meter is just below the desired threshold.

Turn the EXT AGC - FWD trimmer clockwise until the reading of amplifier output power begins to decrease.

Set exciter power to minimum setting.

Disconnect the dummy load from the amplifier and replace it with a mismatch load so that part of the output power is reflected back and set amplifier meter to measure reflected power.

Gradually increase exciter output power until the reflected power reading on the amplifier meter is just above the desired threshold.

Turn the EXT AGC - RFL trimmer clockwise until the reading of amplifier reflected power begins to decrease.

The trimmer calibration procedure is completed. Thanks to this system, the user may choose the preferred power setting at the exciter, while amplifier forward and reflected power remains within the set thresholds.

6 External Description

This section describes the components found on the front and rear panel of **PTX-LCD**.

6.1 Front Panel

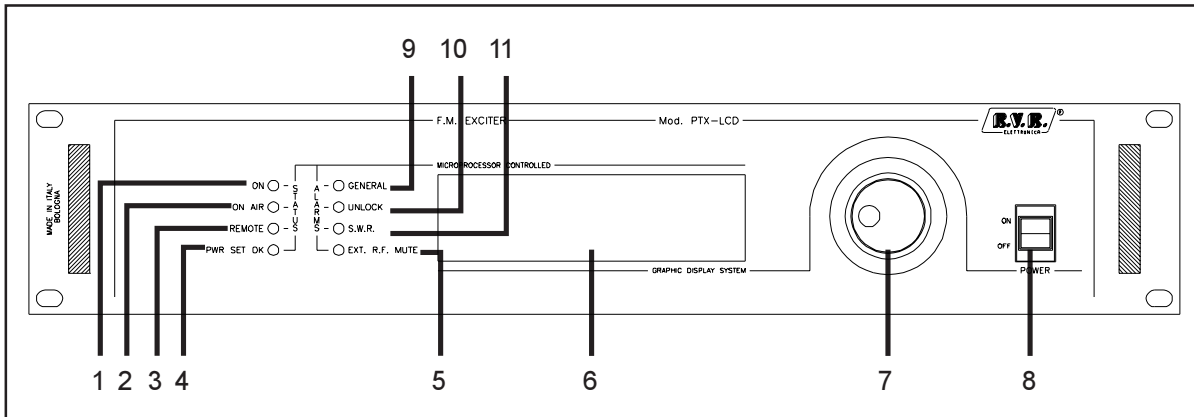

Figure 6-1

- | | |
|-----------------|--|
| [1] ON | Indicates that exciter is switched on |
| [2] ON AIR | Exciter is delivering output power (is on air) |
| [3] REMOTE | Exciter is controlled by an external system |
| [4] PWR SET OK | steady on - Exciter is delivering the set output power flashing: exciter did not reach set power due to external factors |
| [5] EXT RF MUTE | Exciter is not delivering power because inhibited by an interlock |
| [6] DISPLAY | Liquid Crystal Display, supports both graphics (240x64 pixels) and text (30x8 characters) |
| [7] ENCODER | Software control knob and button |
| [8] POWER | Mains power switch |
| [9] GENERAL | Indicates transmitter failure in the event of alarms |
| [10] UNLOCK | PLL not yet locked to set frequency |
| [11] SWR | Transmitter blocked due to exceeding SWR |

6.2 Rear Panel

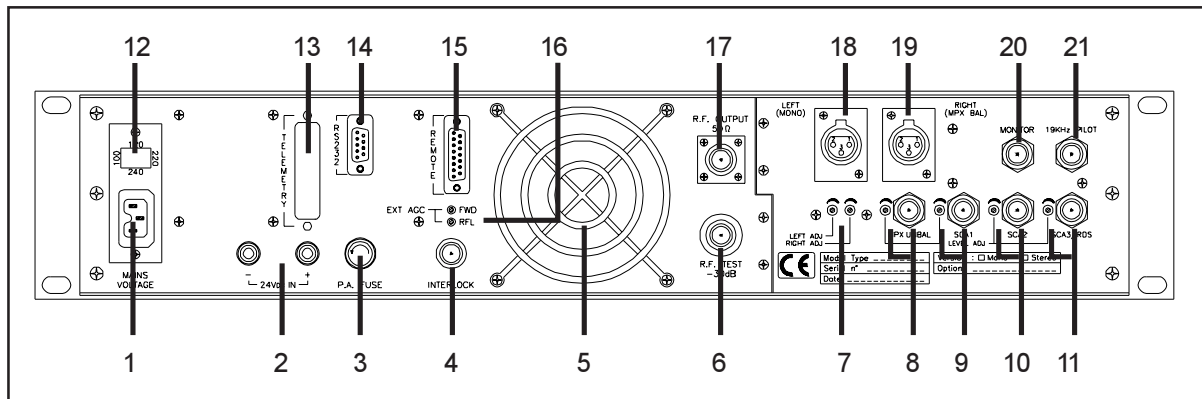
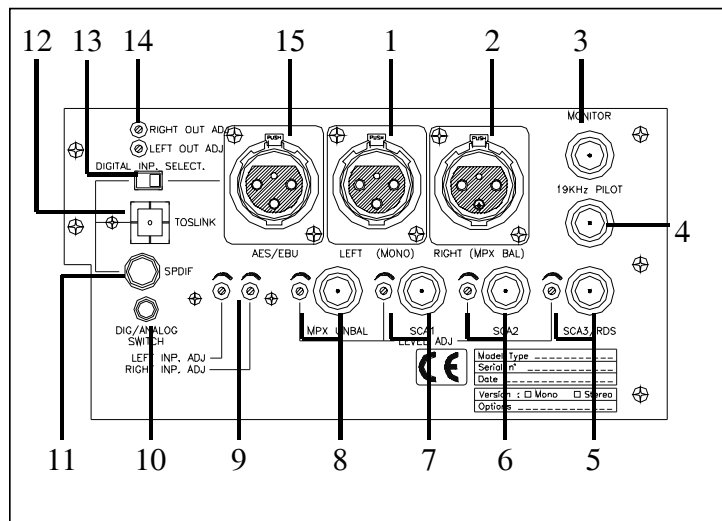

Figure 6-2

[1] PLUG	Mains power plug
[2] 24Vdc IN	Connectors for external 24V power supply (option). Positive (red) and negative (black)
[3] P.A. Fuse	Protection fuse of RF final stage
[4] INTERLOCK	Interlock BNC connector: when central conductor is connected to ground, the transmitter is placed into forced standby mode
[5] VENTOLA	Forced cooling fan
[6] RF Test	Test output at -40 dB with respect to output level
[7] LEVEL ADJ	Trimmers for Left and Right input level adjustment
[8] MPX Unbal	Unbalanced MPX input BNC connector with level trimmer
[9] SCA1	BNC connector for SCA1 input with level trimmer
[10] SCA2	BNC connector for SCA2 input with level trimmer
[11] SCA3/RDS	SCA3/RDS BNC connector for SCA3/RDS input with level trimmer
[12] FUSE	Power supply fuse and voltage selection block
[13] Telemetry	DB25 connector of telemetry card (option)
[14] RS232	DB9 connector for direct serial communication or modem
[15] Remote	DB15 connector for interface to remote devices
[16] EXT AGC	Trimmer for automatic gain control based on external signals
[17] RF Output	N connector for RF output
[18] Left (mono)	XLR connector for left / mono audio channel input
[19] Right (MPX)	XLR connector for right / MPX audio channel input
[20] Monitor	BNC connector for VCO section input signal monitoring
[21] 19 kHz pilot	Pilot tone output BNC connector, may be used to synchronise external devices such as RDS coder

6.3 Rear Panel - AUDINP-DIG option



Analogue section

- | | |
|---------------------|--|
| [1] Left (Mono) | XLR connector for Left / mono input |
| [2] Right (MPX BAL) | XLR connector for Right / MPX input |
| [3] Monitor | BNC connector for composite signal monitoring |
| [4] 19 kHz pilot | BNC connector for output tone control, may be used to synchronise external devices (such as RDS coder) |
| [5] SCA3/RDS | SCA3/RDS BNC connector, with level trimmer |
| [6] SCA2 | SCA2 BNC connector, with level trimmer |
| [7] SCA1 | SCA1 BNC connector, with level trimmer |
| [8] MPX Unbal | Unbalanced MPX BNC connector, with input with level trimmer |
| [9] Level INP ADJ | Trimmers for Left and Right input adjustment |

Digital section

- | | |
|--------------------------|---|
| [10] Dig/Analog switch | 3.5 mm JACK, connector for external Digital/Analogue command |
| [11] SPDIF | Unbalanced PIN/RCA connector for S/PDIF audio input |
| [12] TOSLINK | Fibre optic digital audio input connector |
| [13] Digital Imp. Select | Switch for balanced or unbalanced digital audio input selection |
| [14] Level OUT ADJ | Trimmer for Left and Right level adjustment of converted digital audio signal |
| [15] AES/EBU | Balanced XLR connector for AES/EBU digital audio input |

6.4 Rear Panel - TRDSP option

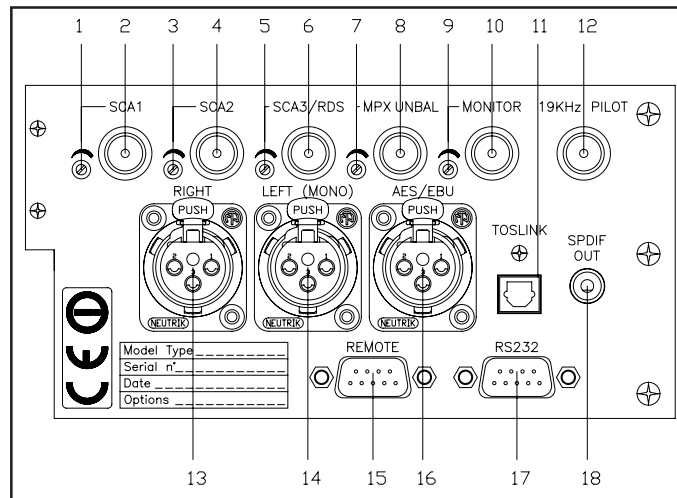

- | | |
|--------------------|--|
| [1] SCA1 | Input connector, BNC type |
| [2] SCA1 lvl. | SCA1 level trimmer |
| [3] SCA2 | SCA2 input connector, BNC type |
| [4] SCA2 lvl. | SCA2 level trimmer |
| [5] SCA3/RDS | SCA3/RDS input connector, BNC type |
| [6] SCA3/RDS lvl. | SCA3/RDS level trimmer |
| [7] MPX UNBAL | Unbalanced MPX input connector, type BNC |
| [8] MPX UNBAL lvl. | MPX UNBAL level trimmer |
| [9] MONITOR | BNC connector for VCO section input signal monitoring |
| [10] MONITOR lvl. | MONITOR level trimmer |
| [11] TOS-LINK | Fibre optic digital audio input connector |
| [12] 19 kHz pilot | BNC connector for output tone control, may be used to synchronise external devices (such as RDS coder) |
| [13] Right | Right input connector, type XLR |
| [14] Left | Left input connector, type XLR |
| [15] Remote | DB15 connector for interface to remote devices |
| [16] AES/EBU | Balanced XLR connector for AES/EBU digital audio input |
| [17] RS232 | DB9 connector for direct serial communication or modem |
| [18] SPDIF | Unbalanced PIN/RCA connector for S/PDIF audio input |

6.5 Rear Panel - GSM option

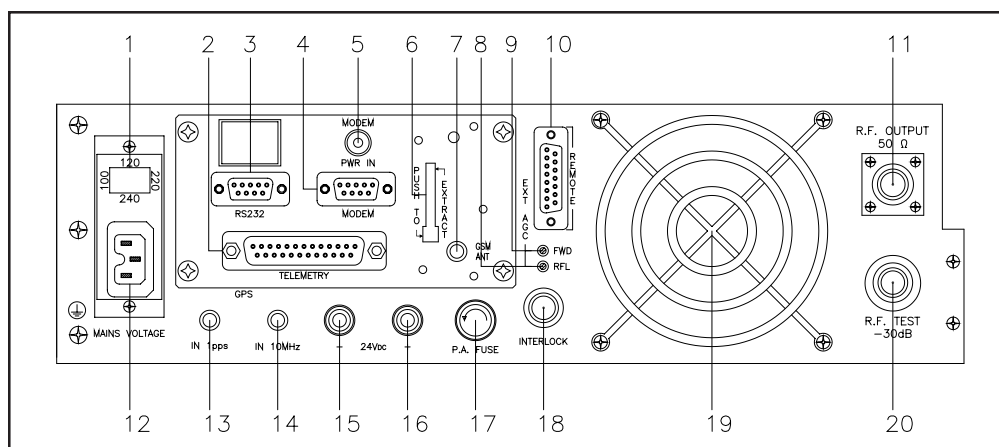

Figure 6-3

- | | |
|-----------------|--|
| [1] FUSE | Power supply fuse and voltage selection block |
| [2] TELEMETRY | DB25 connector of telemetry card (option) |
| [3] RS232 | DB9 connector for direct serial communication or modem |
| [4] MODEM | DB9 connector connected to GSM modem |
| [5] SUPPLY GSM | Power supply plug of GSM modem |
| [6] SIM SLOT-IN | GSM card slot. Press button to extract card from slot. |
| [7] GSMANT | SMA connector for GSM Antenna |
| [8] RFL | Trimmer for automatic gain control based on reflected power |
| [9] RFL | Trimmer for automatic gain control based on reflected power |
| [10] REMOTE | DB15 connector for interface to remote devices |
| [11] RF Output | N connector for RF output |
| [12] PLUG | Mains power plug |
| [13] IN 1PPS | Reserved for future implementations |
| [14] IN 10MHz | Sync signal input BNC connector for external devices |
| [15] 24Vdc IN + | Connectors for external 24V power supply (option). Positive (red) |
| [16] 24Vdc IN - | Connectors for external 24V power supply (option). Negative (black) |
| [17] P.A. Fuse | Protection fuse of RF final stage |
| [18] INTERLOCK | Interlock BNC connector: when central conductor is connected to ground, the transmitter is placed into forced standby mode |
| [19] FAN | Forced cooling fan |
| [20] RF Test | Test output at -30 dB with respect to output level |

6.6 Connectors description

6.6.1 Remote

Type: Female DB15

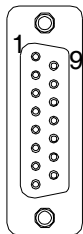

- | | |
|----|---|
| 1 | Ext Rem - Interlock input, disables tx if connected to ground |
| 2 | Ext Rfl Pwr - Analogue input (Max. $2V_{DC}$) for reflected power from external amplifier |
| 3 | GND |
| 4 | Analogue Input 5 or I ² C bus SDA * |
| 5 | Analogue Input 3 |
| 6 | Analogue Input 1 |
| 7 | RLY 2 Out - Digital output. Normally open relay contact; it is closed to ground according to a preset on/off time when exciter state changes from ON to OFF. If the ExPwr menu is disabled (see 11.7), the states of this contact have the following meanings: closed = Power Good; open = alarm. |
| 8 | GND |
| 9 | GND |
| 10 | Ext Fwd Pwr - Analogue input (Max. $2V_{DC}$) for forward power from external amplifier |
| 11 | Analogue Input 6 or I ² C bus SCL * |
| 12 | Analogue Input 4 |
| 13 | Analogue Input 2 |
| 14 | GND |
| 15 | RLY 1 Out - Digital output. Normally open relay contact; it is closed to ground according to a preset on/off time when exciter state changes from OFF to ON. If the ExPwr menu is disabled (see 11.7), this contact serves as a "AUDIO alarm": closed = Alarm; open = OK. |

* : the function is determined by jumper JP10 on the power supply card. When jumper JP10 is ON, PIN4 is the FAULT signal input (see Sect. 13.12.1.5), whereas PIN11 is the MAINS FAULT signal input.

6.6.2 RS 232

Type: Female DB9

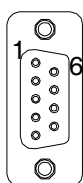

- | | |
|---|------|
| 1 | NC |
| 2 | TX_D |
| 3 | RX_D |
| 4 | NC |
| 5 | GND |
| 6 | +12V |
| 7 | NC |
| 8 | CTS |
| 9 | NC |

Note: Normally, **PTX-LCD** serial communication is configured as DCE (Data Communication Equipment).

6.6.3 Left (MONO) / Right (MPX Bal)

Type: female XLR

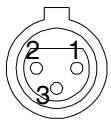

- 1 GND
- 2 Positive
- 3 Negative

6.6.4 Telemetry “SLTELEM00001” Opt.

Type: Female DB25

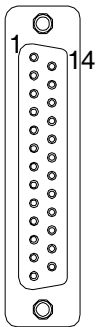

- 1 GND
- 2 +12V
- 3 NC
- 4 relay 1, normally closed contact
- 5 relay 2, common contact
- 6 IIC clock
- 7 IIC data
- 8 open collector output
- 9 telemetry analogue input 1
- 10 telemetry analogue input 3
- 11 telemetry analogue input 5
- 12 telemetry analogue input 7
- 13 GND
- 14 GND
- 15 relay 1, normally opened contact
- 16 relay 1, common contact
- 17 relay 2, normally opened contact
- 18 relay 2, normally closed contact
- 19 GND
- 20 GND
- 21 GND
- 22 telemetry analogue input 2
- 23 telemetry analogue input 4
- 24 telemetry analogue input 6
- 25 telemetry analogue input 8

6.6.5 Telemetry “SLTELEM00002” Opt.

Type: Female DB25

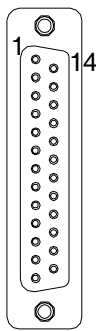

1	N.C.
2	Audio Auto (Meldung)
3	GND
4	Audio Auto (Kommando)
5	Audio Digital (Meldung)
6	N.C.
7	GND
8	ON (Kommando)
9	Power Good 1 (Meldung)
10	Warten (Meldung)
11	Audio Digital (Kommando)
12	Off (Meldung)
13	RF Enable (Kommando)
14	SWR (Meldung)
15	Reserved
16	Audio Analogue (Kommando)
17	Fault (Meldung)
18	Audio Alarm (Meldung)
19	Reserved
20	Off (Kommando)
21	GND
22	Power Good 2 (Meldung)
23	Local (Meldung)
24	+Vout
25	On (Meldung)

7. Operating System

The exciter is controlled by a microprocessor system. Software operations may be grouped into two broad categories: start-up and normal operation.

7.1 Start-up

Upon switch-on, a window that holds machine information appears on the display. Label "CCIR" identifies the set of default values the machine will revert to in the event the software is reinitialised. There are different sets of default values; see section 11 for a detailed description.

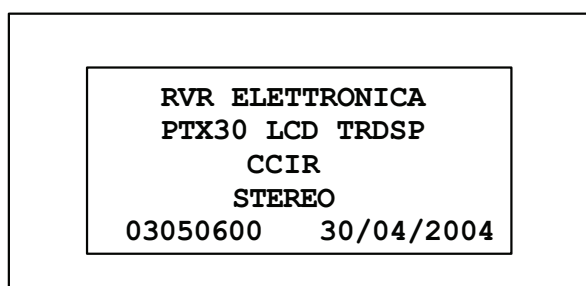

After 10 seconds, a new window appears with an intermittent beep signal.

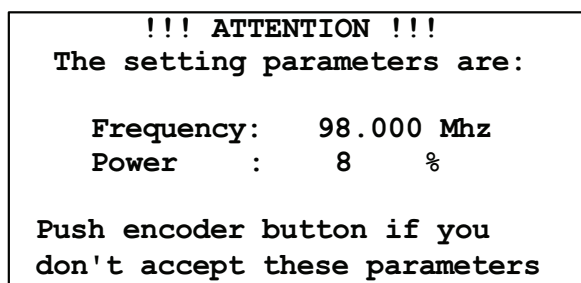

Pressing the encoder while this screen is displayed disables exciter power output. This way, the user may make any necessary changes to operating parameters before beginning transmission.

If no controls are operated during 5 seconds, or if the encoder is pressed, the exciter goes to the main screen (MAIN).

7.2 Operating System

The **PTX-LCD** menu system consists of a default menu and set of administration menus.

The figure below provides an overview of the menu system.

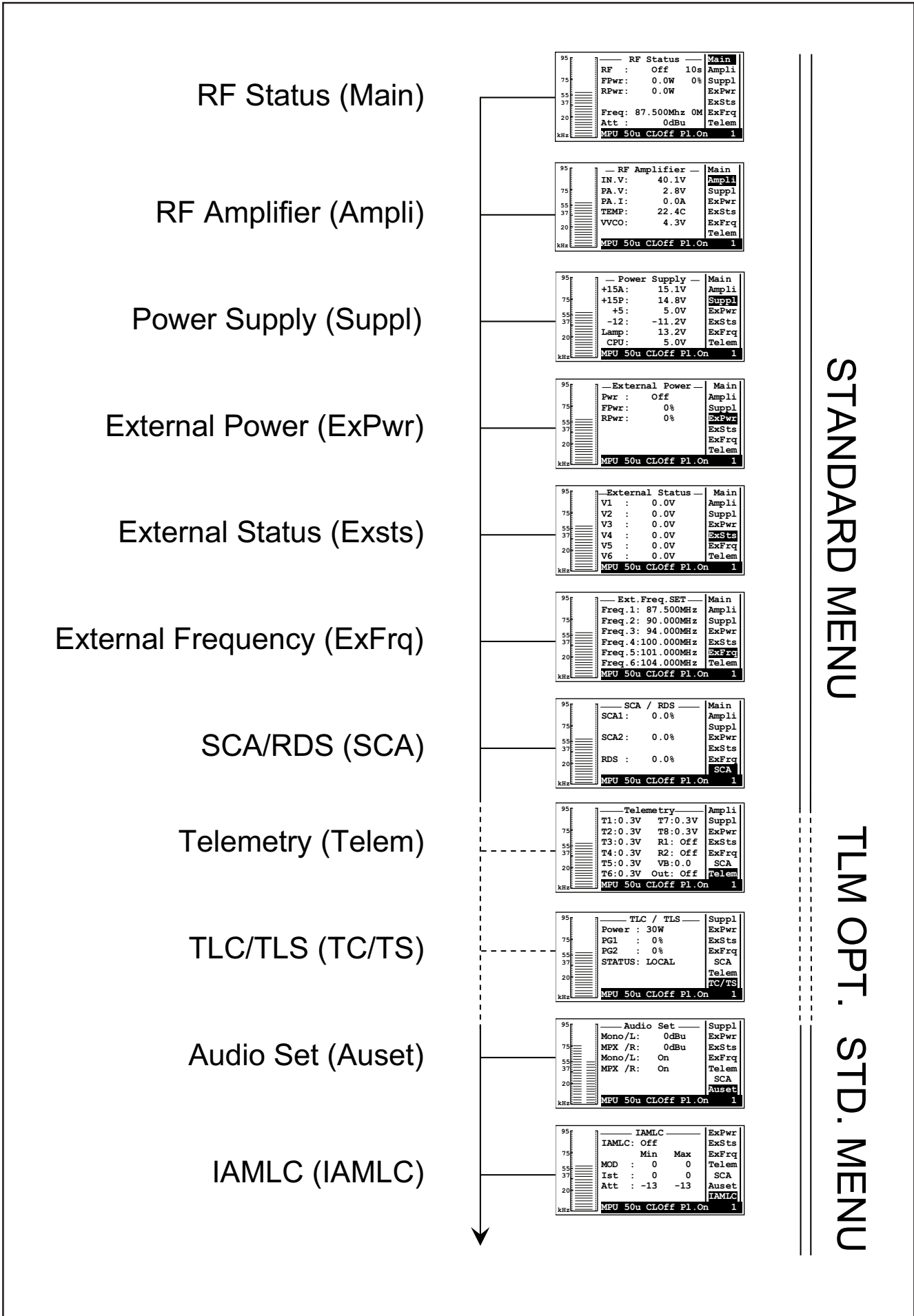

```

95  --- RF Status --- Main
75  RF : Off 10s Ampli
55  FPwr : 0.0W 0% Suppl
37  RPwr : 0.0W ExPwr
20  Freq: 87.500Mhz 0M ExFrq
10  Att : 0dBu Telem
MHz MPU 50u CLOff Pl.On 1
    
```

```

95  --- RF Amplifier --- Main
75  IN.V: 40.1V Ampli
55  PA.V: 2.8V Suppl
37  PA.I: 0.0A ExPwr
20  TEMP: 22.4C ExSts
10  VVCO: 4.3V ExFrq
MHz Telem
MPU 50u CLOff Pl.On 1
    
```

```

95  --- Power Supply --- Main
75  +15A: 15.1V Ampli
55  +15P: 14.8V Suppl
37  +5 : 5.0V ExPwr
20  -12: -11.2V ExSts
10  Lamp: 13.2V ExFrq
MHz Telem
CPU : 5.0V
MPU 50u CLOff Pl.On 1
    
```

```

95  --- External Power --- Main
75  Pwr : Off Ampli
55  FPwr : 0% Suppl
37  RPwr : 0% ExPwr
20  ExSts
10  ExFrq
MHz Telem
MPU 50u CLOff Pl.On 1
    
```

```

95  --- External Status --- Main
75  V1 : 0.0V Ampli
55  V2 : 0.0V Suppl
37  V3 : 0.0V ExPwr
20  V4 : 0.0V ExSts
10  V5 : 0.0V ExFrq
MHz Telem
V6 : 0.0V
MPU 50u CLOff Pl.On 1
    
```

```

95  --- Ext. Freq. SET --- Main
75  Freq.1: 87.500MHz Ampli
55  Freq.2: 90.000MHz Suppl
37  Freq.3: 94.000MHz ExPwr
20  Freq.4:100.000MHz ExSts
10  Freq.5:101.000MHz ExFrq
MHz Telem
Freq.6:104.000MHz
MPU 50u CLOff Pl.On 1
    
```

```

95  --- SCA / RDS --- Main
75  SCA1: 0.0% Ampli
55  SCA2: 0.0% Suppl
37  RDS : 0.0% ExPwr
20  ExSts
10  ExFrq
MHz SCA
MPU 50u CLOff Pl.On 1
    
```

```

95  --- Telemetry --- Ampli
75  T1:0.3V T7:0.3V Suppl
55  T2:0.3V T8:0.3V ExPwr
37  T3:0.3V R1: Off ExSts
20  T4:0.3V R2: Off ExFrq
10  T5:0.3V VB:0.0 SCA
MHz Telem
T6:0.3V Out: Off
MPU 50u CLOff Pl.On 1
    
```

```

95  --- TLC / TLS --- Suppl
75  Power : 30W ExPwr
55  PG1 : 0% ExSts
37  PG2 : 0% ExFrq
20  STATUS: LOCAL SCA
10  Telem
MHz AC/TS
MPU 50u CLOff Pl.On 1
    
```

```

95  --- Audio Set --- Suppl
75  Mono/L: 0dBu ExPwr
55  MPX /R: 0dBu ExSts
37  Mono/L: On ExFrq
20  MPX /R: On Telem
10  SCA
MHz Auset
MPU 50u CLOff Pl.On 1
    
```

```

95  --- IAMLC --- ExPwr
75  IAMLC: Off ExSts
55  MOD : 0 0 ExFrq
37  Ist : 0 0 SCA
20  Att : -13 -13 Auset
MHz IAMLC
MPU 50u CLOff Pl.On 1
    
```

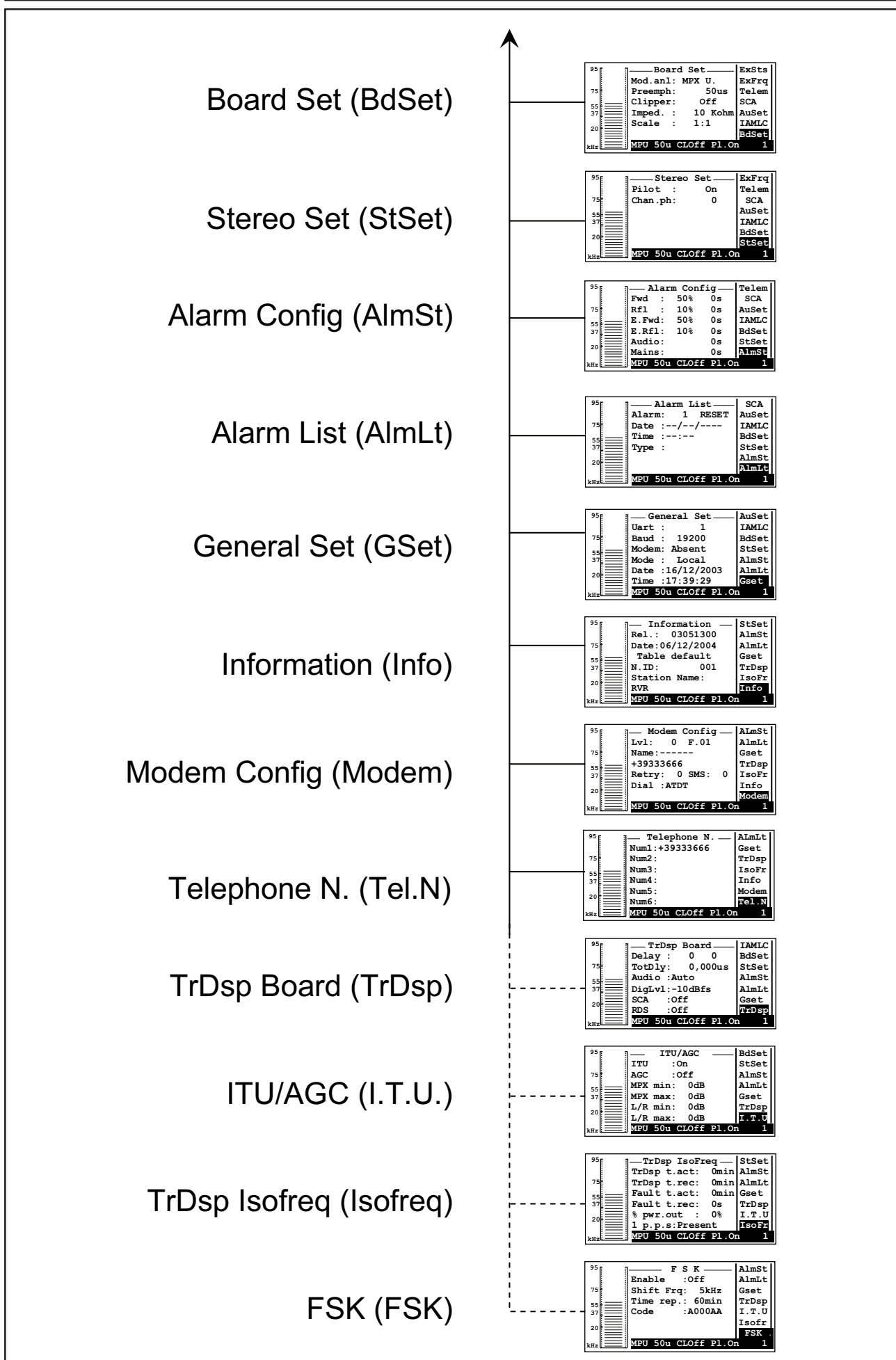

7.2.1.2 Status Bar

This "status bar" relates to certain settings that can be modified from the administration submenus; these settings are discussed in greater detail further below.

- **STE 50u CL.On Pl.On 001**

Ste Audio operating mode: Stereo/Mono/MPX_U/MPX_B

50u Preemphasis: 0, 25, 50, 75 microseconds

Cl Clipper feature, On or Off

Pl Pilot tone transmission, On or Off

001 Machine address (from 001 to 200), relevant when machine is integrated into a telemetry transmission system.

Turning the encoder moves the cursor to the next submenu label, while its content appears in the centre of the window.

If the encoder is pressed when a menu indicator is highlighted on the navigation bar, and that menu contains editable parameters, the cursor jumps into the window in the centre of the display to enable editing.

All menus of this type contain an "EXIT" field: press the encoder when this field is highlighted to exit the submenu and return to navigation mode.

7.2.2 Administration menu

7.2.2.1 RF Status

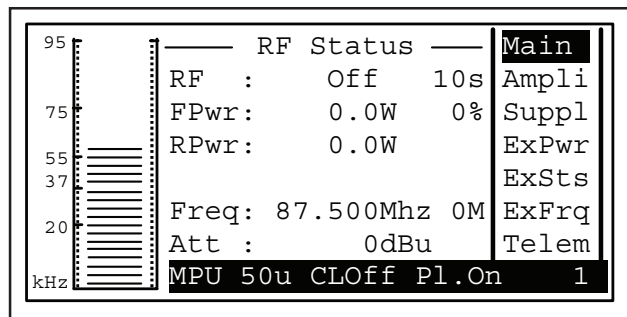

- RF** RF power output On / Off. Reading and setting of time taken by the **PTX-LCD** to reach set power; setting range 1 to 100s
- FPwr** Output power reading and setting. Reading is expressed in Watts, whereas setting is a percentage of maximum power. If the encoder is pressed when the cursor is on this option, measurement unit label changes from "W" to "%" and the desired percentage can be set by turning the encoder. Press the encoder to store the new setting.
- RPwr** Reflected power reading in watts.
- 0%** Output power setting in percent
- Freq** Operating frequency. Press the encoder when this parameter is highlighted and then turn the encoder to change frequency value. When the encoder is pressed to store the new frequency setting, the software will prompt for a confirmation ("Are you sure?"). Highlight "Yes" and press the encoder to confirm the new frequency setting or select "No" to abandon change. Value "0M" near the MHz indication identifies the current frequency selection (set from menu "ExFrq") in the event the frequency switching feature is on (switching occurs based on the voltage present at connector DB15).
- Att** Gain set at audio inputs.

7.2.2.2 RF Amplifier

This is an information screen; it shows amplifier voltage, current and temperature values, which cannot be modified.

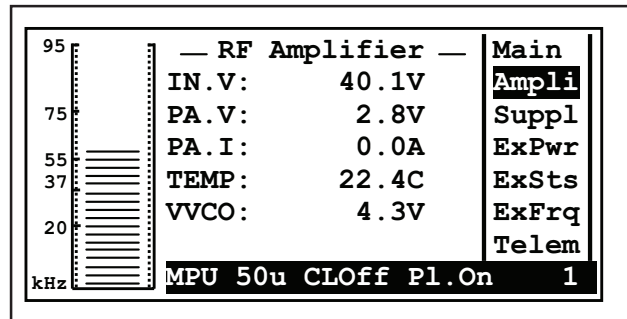

- IN.V Power supply input voltage
- PA.V Voltage applied to final stage of amplifier
- PA.I Current applied to final stage of amplifier
- TEMP amplifier module temperature
- VVCO Voltage applied to VCO section

7.2.2.3 Power Supply

This is an information screen showing the different voltages supplied by the amplifier:

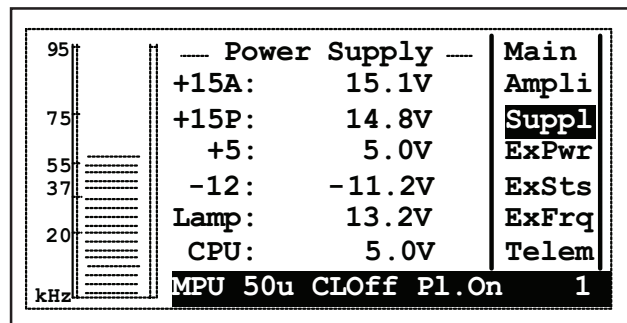

- +15A Main supply voltage to audio, pll, coder circuits; it is reduced to 8 Volts on the MAIN AUDIO BOARD.
- +15P Supply voltage to control logic panel.
- +5 Voltage in power supply digital circuits.
- 12 Negative voltage of main power supply.
- LAMP Display lamp supply voltage; typically, 13 Volts.
- CPU CPU supply voltage.

7.2.2.4 External Power

External amplifier control menu.

This menu may or may not be available, depending on machine jumper settings (see 11.7.1). Use of this menu requires certain power amplifier features (amplifier may be turned on and off by opening a contact and is capable of providing proportional voltages to forward and reflected power).

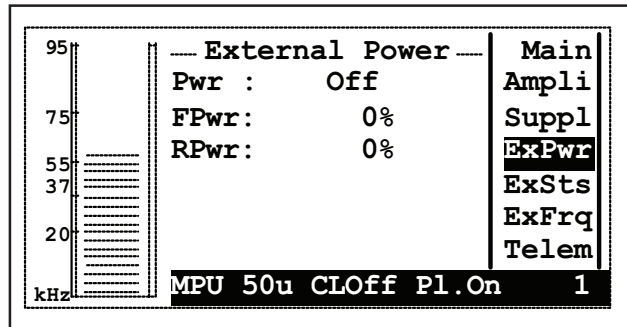

PWR Status indicator, command relates to the **PTX-LCD** mode (MAIN menu).

FPWR Forward power supplied by external amplifier expressed in percent.

RPWR Reflected power supplied by external amplifier expressed in percent.

7.2.2.5 External Status

Monitoring menu for input voltages from a telemetry-equipped equipment.

This menu may or may not be available, depending on machine jumper settings (see 11.7.1).

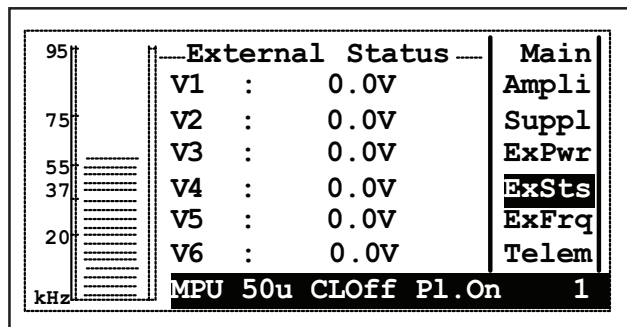

V1 Input voltage at pin 6 of REMOTE connector expressed in Volts (max 5 Volts).

V2 Input voltage at pin 13 of REMOTE connector expressed in Volts (max 5 Volts).

V3 Input voltage at pin 5 of REMOTE connector expressed in Volts (max 5 Volts).

- V4 Input voltage at pin 12 of REMOTE connector expressed in Volts (max 5 Volts).
- V5 Input voltage at pin 4 of REMOTE connector expressed in Volts (max 5 Volts).
- V6 Input voltage at pin 11 of REMOTE connector expressed in Volts (max 5 Volts).

7.2.2.6 Ext. Freq. SET

Frequency switching menu, switching is based on voltage present in previous menu. This menu may or may not be available, depending on machine jumper settings (see 11.7.1).

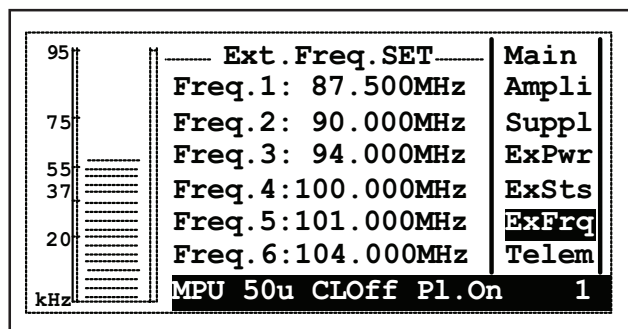

- Freq 1 Default service frequency
- Freq 2-6 Service frequencies of transmitters 2-6

7.2.2.7 SCA / RDS

This menu shows the modulation levels achieved by the SCA and RDS inputs in the PTX-LCD.

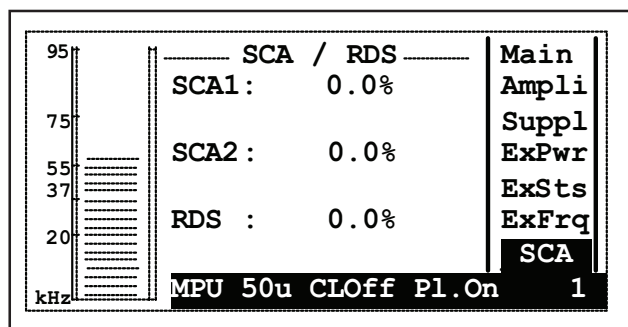

The PTX-LCD has three subcarrier transmission inputs named SCA1, SCA2 and RDS. This menu shows the modulation level achieved by each input both in kHz and in percent.

7.2.2.8 Audio Set

Audio settings: channels on/off and level adjustment.

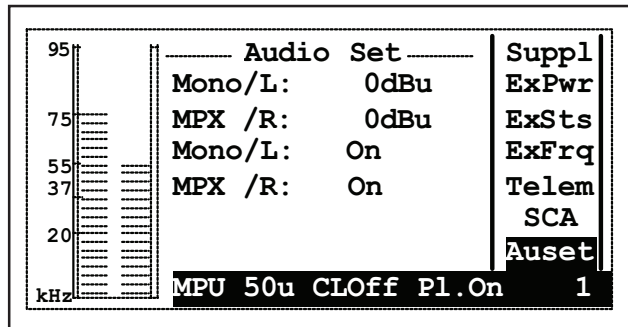

MONO/L Setting of audio input level on MONO channel (left channel if stereo version). It is adjusted in 1 dBu steps in a -13 to +14 dBu range. If parameter is set to X dBmu, the system generates a 75 kHz deviation for an X dBu input.

MPX/R Setting of audio input level on MPX channel (right channel if stereo version). It is adjusted in 1 dBu steps in a -13 to +14 dBu range. Set level has the same meaning as for the first channel.

MONO/L Software switch to set MONO channel On / Off (left channel if stereo version).

MPX/R Software switch to set MPX channel On / Off (right channel if stereo version).

When the exciter is placed in STEREO mode from the BdSet menu (for stereo version), the same level adjustment is forced on both channels.

7.2.2.9 IAMLC

Intelligent Automatic Modulation Level Control.



NOTE: If the machine is not equipped with the optional TRDSP card, this menu is not displayed.

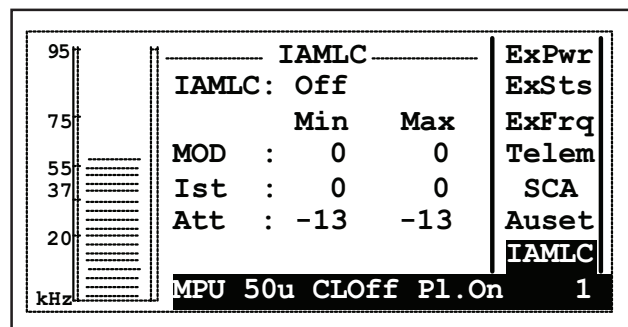

The IAMLC feature of the **PTX-LCD** controls modulation level by adjusting input level without the use of limiters or compressors.

When mean modulation remains over the set maximum threshold for a period of time greater than set maximum hysteresis time, input level is attenuated by 1 dB. Likewise, when mean modulation remains under the set minimum threshold for period of time greater than set minimum hysteresis time, input level is boosted by 1 dB. The maximum limits for automatic control attenuation and boost are user-selectable. Listed below are the menu elements:

IAMLC	Function enable/disable
Mod	Minimum and maximum threshold for IAMLC operation
Ist	Operation time at minimum threshold and at maximum threshold
Att	Minimum and maximum operation limit

The recommended settings for different type of music programmes are listed in the following table:

Radio Program	Mod Min	Mod Max	Ist Min	Ist Max	Att Min	Att Max
Dance	75 %	100 %	10 s	1 s	-3 dBm	+6 dBm
Pop, rock	30 %	100 %	20 s	0,5 s	-3 dBm	+6 dBm
Electronic	50 %	100 %	10 s	1,5 s	-3 dBm	+3 dBm
Jazz	40 %	100 %	5 s	0,5 s	-3 dBm	+6 dBm
Classical	20 %	92 %	30 s	0,5 s	-4 dBm	+10 dBm
Talk show	40 %	85 %	30 s	1 s	-3 dBm	+14 dBm

For this function to perform at best, it is recommended that you perform some tests with your music programmes in order to identify optimal parameter settings:

- Use the MODPK menu to determine mean modulation. Adjust audio input level (from the main menu) so as to achieve a mean modulation as close to 100% as possible.
- Set the IAMLC parameters listed in the table; try different settings so as to keep IAMLC operation within reasonable limits. Note that operation stops when modulation rises above the minimum threshold and drops below the minimum threshold.
- Using the clipper circuit (BdSet menu) helps contain peaks exceeding 100 % of modulation, but introduces a certain amount of distortion. Evaluate whether this limiter is necessary based on your music programme requirements.

The figure provides an example of the mean modulation level trend when the IAMLC feature is available.

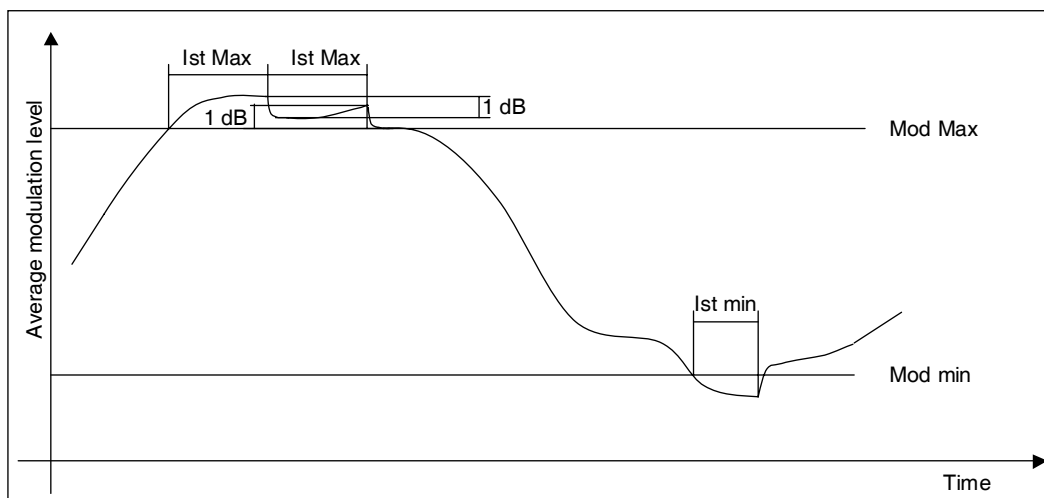

7.2.2.10 BoardSet

Modulation mode configuration

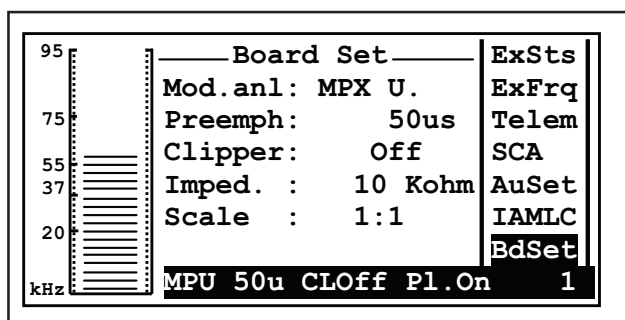

- Mode Transmission mode selector: MONO, MPX_U (unbalanced MPX BNC input), MBX_B (balanced MPX XLR input), STEREO. The latter option is only enabled on the version with stereo coder.
- Preemph Preemphasis setting, 0, 25, 50 or 75 us. Preemphasis affects the right and left inputs in stereo mode and the mono input. MPX inputs are not affected by preemphasis setting.
- Clipper Deviation limiter enable/disable. Limits deviation to 81.5 kHz for input levels 6 dB greater than input reference (main menu)
- Imped Impedance of balance audio inputs; setting possibilities are 600 or 10k Ohm.
- Scale Modulation level graphic scale ratio. It can be set to 1:1 (standard scale) or 1:10 (magnified 10 times, convenient when evaluating modulation for low input levels).

7.2.2.11 Stereo Set

Configuration menu for stereo coder card (where relevant option is installed).

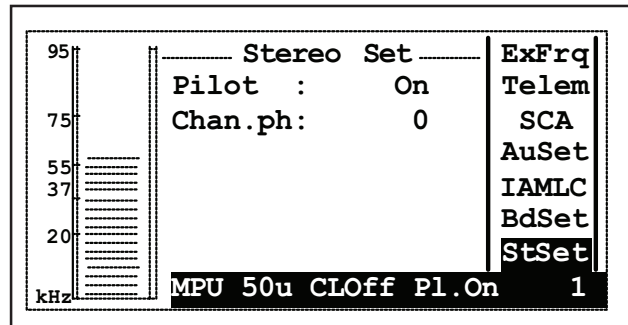

- Pilot Add/remove pilot tone (convenient for some types of measurements)
- Chan.ph Right channel phase, may be 0 or 180 (signal reversal, convenient when measuring "Sub to Main").

7.2.2.12 Alarm Config

Telemetry and remote alarm reporting management menu.



Before accessing edit mode for the different parameters, ensure that the machine has been placed into "LOCAL" mode from the General Set menu, or you will keep getting alarm messages during the whole setting procedure. When finished, place machine back into "REMOTE" mode to activate remote alarm reporting.

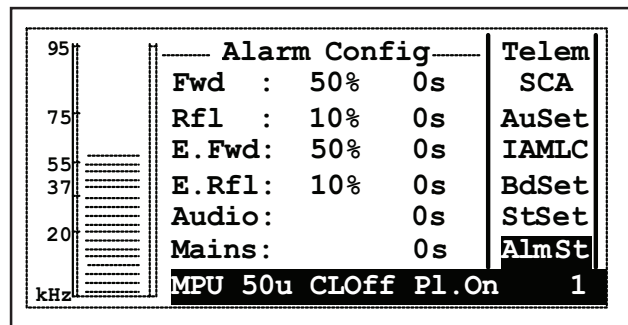

- FWD Setting of the **PTX-LCD** forward power alarm. Alarm is triggered when output power drops below the set percent threshold for the set time (expressed in seconds).
- RFL Setting of the **PTX-LCD** reflected power alarm. Alarm is triggered when output power rises above the set percent threshold for the set time (expressed in seconds).
- E.FWD Setting of external exciter forward power alarm. Alarm is triggered when output power drops below the set percent threshold for the set time (expressed in seconds).

- E . RFL Setting of external exciter reflected power alarm. Alarm is triggered when output power rises above the set percent threshold for the set time (expressed in seconds).
- AUDIO Alarm setting for audio input signal to the **PTX-LCD**. Alarm is triggered for the set time.
- MAINS To handle MAINS alarm, attach jumper no. 10 to JP8 on the **PTX-LCD** panel board and move the jumpers at JP6 on the power supply card from positions 3-5 and 4-6 to 1-3 and 2-4.
Provide an auxiliary power supply source for the **PTX-LCD** through a generating set, a UPS unit or through the 24V power supply terminals (if available on the **PTX-LCD**) for the event of mains outage. Shown below is a hookup diagram for an R.V.R. station, where the **PTX-LCD** is configured to handle MAINS alarm .

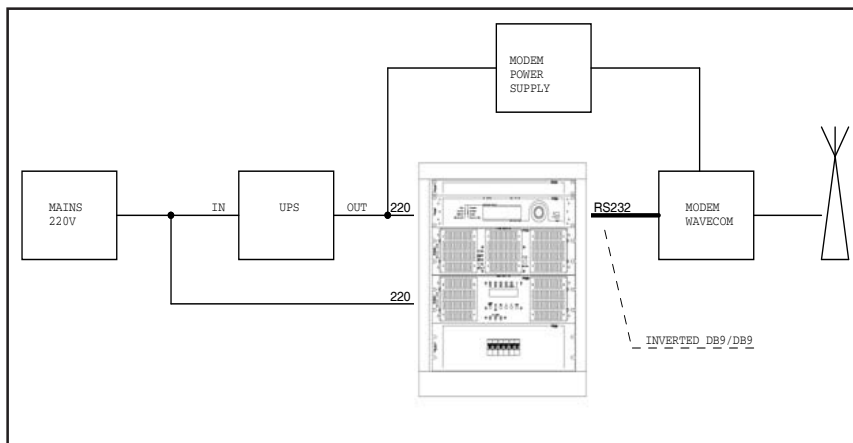

The MAINS alarms is triggered when mains outage duration equals set time.

Shown below is the operating logic of an alarm:

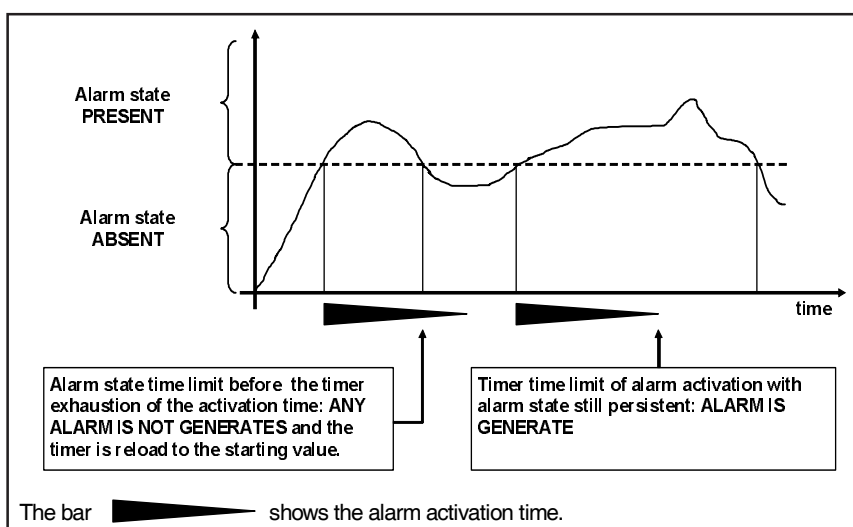

7.2.2.13 Alarm List

Triggered alarms are stored in a non volatile memory and the six events occurred last can be viewed in the "Alarm List" menu.

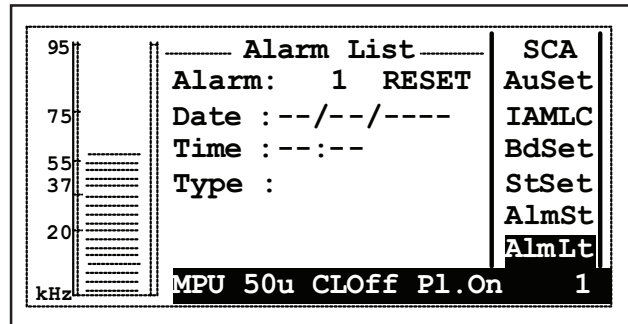

ALARM

Display of stored alarm number. Select one of the six alarms as follows: select number and choose from the list of alarms 1 ... 6 using the encoder. Again using the encoder, move cursor to "RESET" and confirm reset operation to clear all stored events.

DATE

Display of alarm record date.

TIME

Display of alarm record time.

TYPE

Display of stored alarm type.



Note: On start-up, the **PTX-LCD** inhibits alarm reporting for a preset time selected at parameter "StartUp Time" (default setting is 60 seconds); after this delay times out, an INFO SMS on the **PTX-LCD** operation state is transmitted. The "StartUp Time" delay also applies to MAINS alarm; on start-up, the **PTX-LCD** will wait for the set time before sending an INFO SMS.

7.2.2.14 General Set

General Setup Menu.

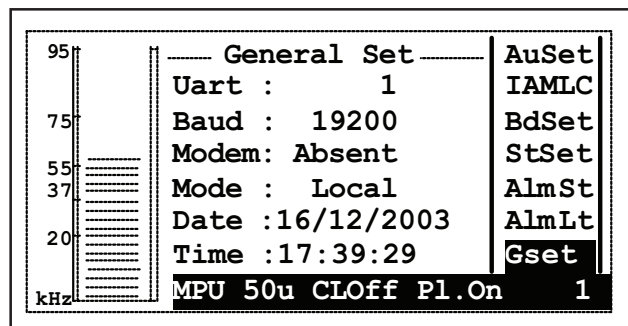

Uart Adr

IIC address of the **PTX-LCD**, selectable from 1 to 200. Unless the exciter is part of a transmission system (for example, N+1), this address must be to 1.

- Baud Rate Baud rate setting for the **PTX-LCD** serial port data transfer.
- MODEM Configures machine to use a modem (Present), for direct cable connection, (Absent), GSM and Pager.
- MODE Local: The machine will not accept changes to parameters from external devices. Remote: Enables remote setting of machine parameters.

7.2.2.15 Information

This menu provides general information on the exciter.

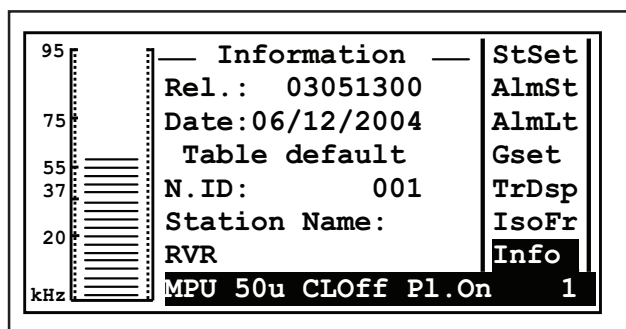

- Rel Exciter software release information.
- Date Software Release date.
- N.ID Identifier used when system is made up of several machines; it may be modified using the TELECON software (please read relevant manual for more details).
- Station Name Name of the station the machine is part of; station name may be modified using the TELECON software (please read relevant manual for more details).

7.2.2.16 Modem

This menu lets you view modem configuration state.

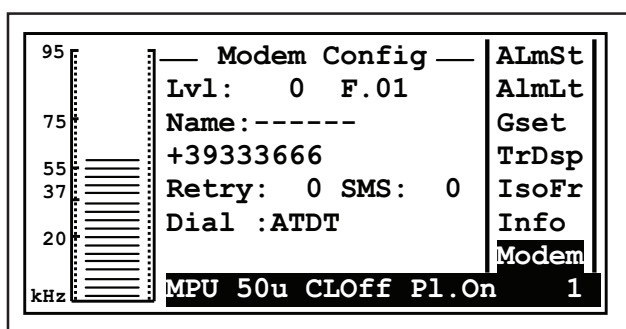

lvl	Signal level indication. Modem state is reported at the side: ST.BY (Stand by), CKSMS (Check SMS), TXSMS (Transmission SMS).
Name	Name of SIM card service provider. The value right below the name is the set service centre number.
Retry	SMS transmission attempts indication.
SMS	Maximum number of SMS's the SIM card can store.
Dial	Type of initialisation string used by Modem.

7.2.2.18 Telephone

This menu displays the first six of ten preset telephone numbers to which an SMS message is to be sent in the event of an alarm.

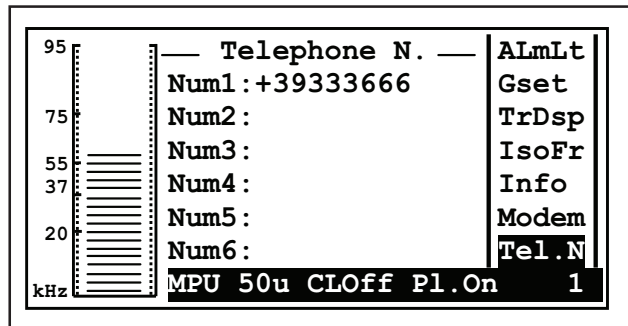

8. System Status Enquiries

8.1 Local enquires

Locally, **PTX-LCD** provides status indications through the front panel lights, whereas more detailed information is available in the setup and configuration menu.

8.2 Remote enquiries using remote control software (Opt.)

Using a PC with the "TELECON" telemetry and remote control software installed, the user can get an accurate picture of all system operating parameters and all device settings (including connected equipments).

8.3 Remote enquires using GSM modem+SMS

Thanks to this system, equipments can be enquired using a common GSM phone; possible equipment responses are listed in the tables included in the following paragraphs.

Before enquiring the system using SMS messages, establish a connection using the "TELECON" programme and set the provider service centre number and the telephone numbers authorized to send these commands to the equipments.

8.3.1 List of supported commands that can be sent via SMS

- These commands can be sent to the **PTX-LCD**:

STANDARD

INFO	Information sent on the system operating state
TXON	"OnAir" PTX-LCD Switch On
TXOFF	"OnAir" PTX-LCD Switch Off
ALARM	Information sent on the alarms present into PTX-LCD list.
RESET	Reset of all stored alarms.
RESMOD	Reset of GSM modem and all SMS present into SIM.

TRDSP AND ISOFREQUENCY OPT.

DELAY xxxxx	TRDSP card delay setting. xxxxx is equivalent to the forward regulation of the delay expressed in μ s, between 0 and 10 ms.
STEP +/-xx	Fine setting of the TRDSP card delay, in adding (+) or in reduction (-). xx are the regulation steps, between 0 and 20, equivalent to 0.05 μ s each.
PH +/-	Phase setting: (+) normalized, (-) inverted.

- Example of the **PTX-LCD** response to received SMS enquires:

STANDARD

INFO	001-Test station=Pwr On,FWD: 12.5W,RFL: 0.1W,ExFWD: 50%, ExRFL: 1%,Frg: 88.520 MHz,Audio Present,GSM Iv=-77,MAINS Present
TXON	001-Test Station=ON Command
TXOFF	001-Test Station=OFF Command
ALARM	001-Test Station=Tot 1/6 -Alarm 02u= 11/02/2004,11:43,Low FWD Power
RESET	Alarm Reset
RESMOD	Reset Modem

TRDSP AND ISOFREQUENCY OPT.

DELAY 624	001-Test Station=Total Delay Set: 624,00 us
STEP +10	001-Test Station=Total Delay Set: 624,50 us
PH +/-	(+) Normalized phase; (-) Inverted phase



Note: The DELAY and STEP commands are only available if the optional TRDSP card is installed



Note: For **PTX-LCD** to actually process the reply or requested command, the GSM number used to send the request must be stored in the list of numbers set in **PTX-LCD**. This does not apply to INFO SMS messages; **PTX-LCD** will answer regardless of whether the originating number is registered or not.

9. Remote Alarm Reporting and Control (Opt.)

The Remote Alarm Reporting and Control service is activated when the PTX-LCD is supplied in one of the following configurations:

- Radio Modem Box (telemetry interface);
- External GSM modem;
- Internal GSM modem (/GSM option).

9.1 Preparation

Ensure that the SIM card to be inserted into the external modem, the internal modem or into the modem housed in the Radio Modem Box is registered for Data & Fax Service (see facsimile contract in Fig. 5.1).

SIM card configuration for DATA/FAX reception must meet the following specifications:

- Asynchronous;
- Transparent;
- 300-9600 Baud.

Maximum connection speed is 9600 baud for transmission over GSM phone line.

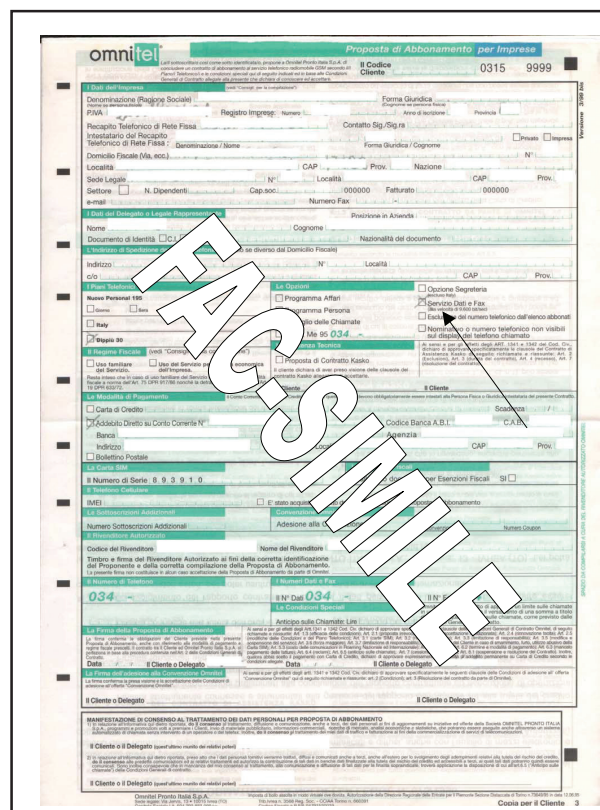

The image shows a facsimile of a 'Proposta di Abbonamento per Imprese' (Business Subscription Proposal) form from omnitele. The form is filled out with various details, including company name, address, phone numbers, and service options. A large, diagonal watermark reading 'FACSIMILE' is overlaid across the center of the form. The form includes sections for 'Dati dell'Incarico', 'Dati del Delegato e Legale Rappresentante', 'Dati del Cliente', and 'Dati del Riveditore'. The form is titled 'Proposta di Abbonamento per Imprese' and includes the omnitele logo and contact information.

Figure 5.1

9.1.1 Radio Modem Box Configuration

Follow the instructions provided below closely to ensure correct configuration of **PTX-LCD** connection:

- 1) Open the Radio Modem Box.
- 2) Insert the SIM card into the GSM modem (see Fig. 5.2).
- 3) Set dipswitches as required (see table 5.1).

SW	PJ2000MC PJ1000M (dig. meter) PJ500M-C HC (dig. meter) PJ1000C	PJ1000M (ana. Meter) HC (ana. Meter)	PJ300M PJ501M
1	OFF	ON	ON
2	OFF	ON	ON
3	ON	OFF	OFF
4	ON	OFF	OFF
5	ON	ON	OFF
6	OFF	OFF	ON
7	ON	ON	OFF
8	OFF	OFF	ON

Table 5.1

- 4) Close the Radio Modem Box.
- 5) Connect the 220V power supplies.
- 6) Connect the RS232 (DB9) cable across the **PTX-LCD** and Radio Modem Box.
- 7) Connect the REMOTE (DB15) cable across the **PTX-LCD** and Radio Modem Box.
- 8) Connect the Telemetry (DB25) cable across Radio Modem Box and amplifier (if fitted).
- 9) Connect the red/black cable across the **PTX-LCD** and Radio Modem Box jacks; take care to avoid possible short circuits.
- 10) Power on the devices.
- 11) Connect PC and Radio Modem Box using the front panel RS232 DB9 connector.
- 12) Programme the internal EEPROM of **PTX-LCD**.
- 13) Before setting the various remote alarm reporting parameters on the **PTX-LCD**, ensure it has been placed into "LOCAL" mode, or you will be getting alarm indications during the whole setting procedure (see **PTX-LCD** Manual, Volume 1, Section "Alarm Config").

If the Radio Modem Box is connected to a **PTX-LCD**, alarm time factory settings are as follows:

MAINS: 10 sec
 FWD: 15 sec
 RFL: 15 sec

If the Radio Modem Box is connected to a **PTX-LCD** with external amplifier, alarm time factory settings are as follows:

MAINS: 10 sec
 Ext. FWD: 15 sec
 Ext. RFL: 15 sec

Mains alarm time must always be lower than FWD and RFL time.

When finished, place **PTX-LCD** back into "REMOTE" mode.

- 14) Disconnect the PC connection cable and connect the supplied DB9/DB9 cable.
- 15) Connect the GSM modem antenna to connector "N" of the Radio Modem Box. Use a broadband Yagi log-periodic directional antenna (700-900 MHz).
- 16) Select modem as "GSM" in **PTX-LCD** settings and set Baud Rate to 9600.

Follow the instructions provided below closely to ensure correct configuration of TLC/SCM connection:

- 1) Open the Radio Modem Box.
- 2) Insert the SIM card into the GSM modem (see Fig. 5.2).
- 3) Set dipswitches as required (see tab. 5.1).
- 4) Close the Radio Modem Box.
- 5) Connect the 220V power supplies.
- 6) Connect the RS232 (DB9) cable across the TLC/SCM unit and the Radio Modem Box.
- 7) Connect the red/black cable across the TLC/SCM unit and Radio Modem Box jacks; take care to avoid possible short circuits.
- 8) Switch on the equipments.
- 9) Connect PC and Radio Modem Box using the front panel RS232 DB9 connector.
- 10) Programme the internal EEPROM (refer to TLC/SCM manual).
- 11) Disconnect the PC connection cable and connect the supplied DB9/DB9 cable.
- 12) Connect the GSM modem antenna to connector "N" of the Radio Modem Box. Use a broadband Yagi log-periodic directional antenna (700-900 MHz).
- 13) Select modem as "GSM" in TLC/SCM settings.

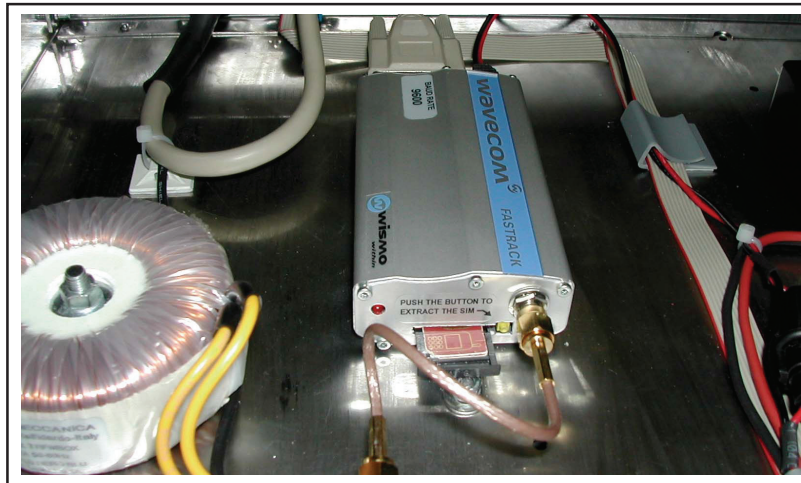
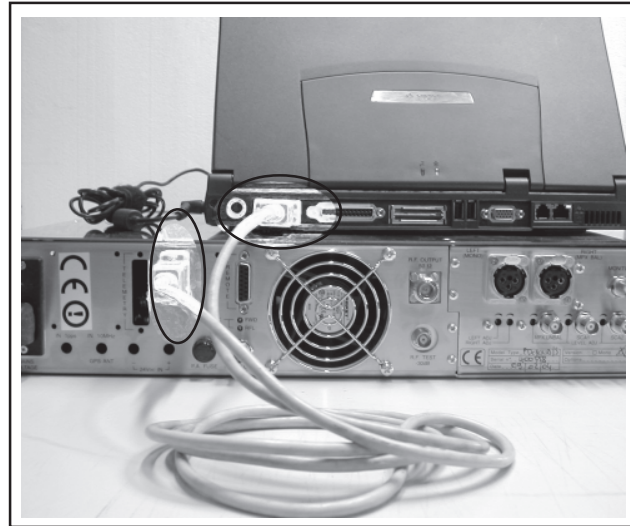

Figure 5.2

9.2 Remote Alarm Reporting COnfiguration

Firstly, you will have to programme certain the **PTX-LCD** parameters using the "TELECON" software. To this end, connect the PC serial port COM to the RS232 connector on the **PTX-LCD** rear panel using a standard Male DB9 - Female DB9 serial cable.



Set the parameters in the "General Set" menu of the **PTX-LCD** as specified below:

95	----- General Set -----	AuSet
	Uart : 1	IAMLC
75	Baud : 9600	BdSet
	Modem: Absent	StSet
55	Mode : Remote	AlmSt
37	Date : 16/12/2003	AlmLt
	Time : 17:39:29	Gset
20	MPU 50u CLOff Pl.On	1
kHz		

When using the "TELECON" software for the first time, select the station and then enter:

- COM port used,
- Baud rate (9600),
- type of connection (direct, via cable).

When you have entered the correct data, click the "Start" button to confirm and the "TELECON" main screen appears, as shown in the figure:

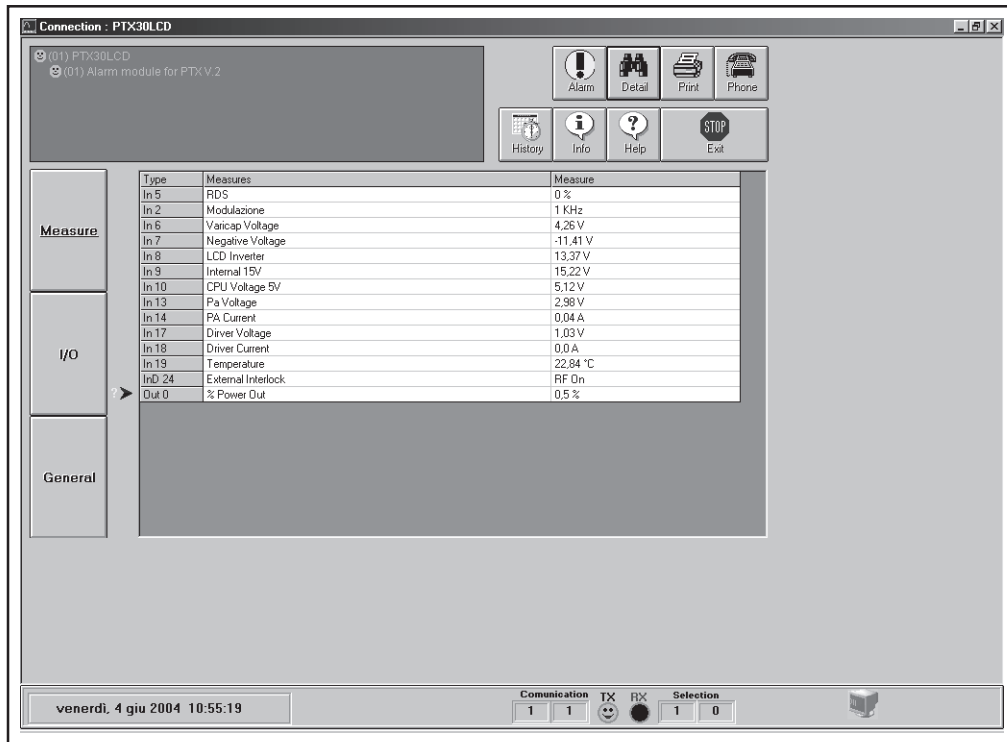

Double click the green label in the top left corner of the TELECON screen and select "Eeprom" (as shown in the figure below).

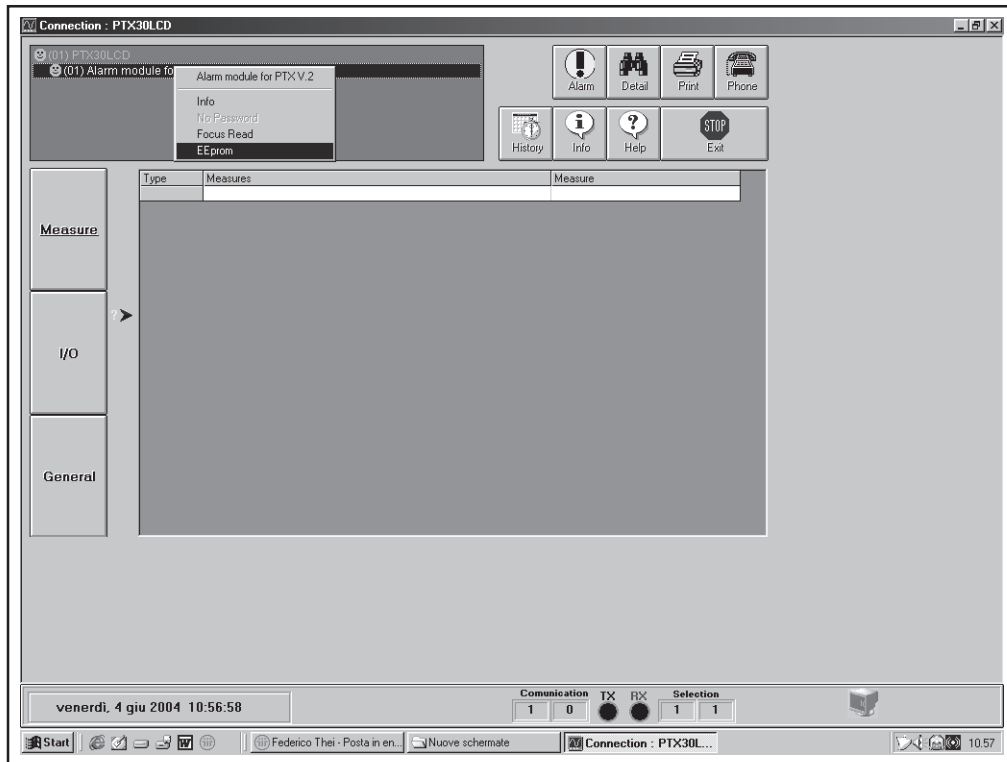



In the open menu, press this key to view station parameters.

Select the "General" data category and set the 5 parameters:

- **STATION ID:** station identifier;
- **STATION NAME:** (max 18 characters);
- **DIAL STRING:** required setting for a GSM modem is ATDT;
- **NUMBER OF RETRY:** number of alarm transmission repetitions;
- **SERVICE CENTER NUMBER:** number of GSM provider service centre for SMS transmission and reception; place country code before number.

Example with Italian service providers:

TIM: +393359609600
 VODAFONE: +393492000200
 WIND: +393205858500

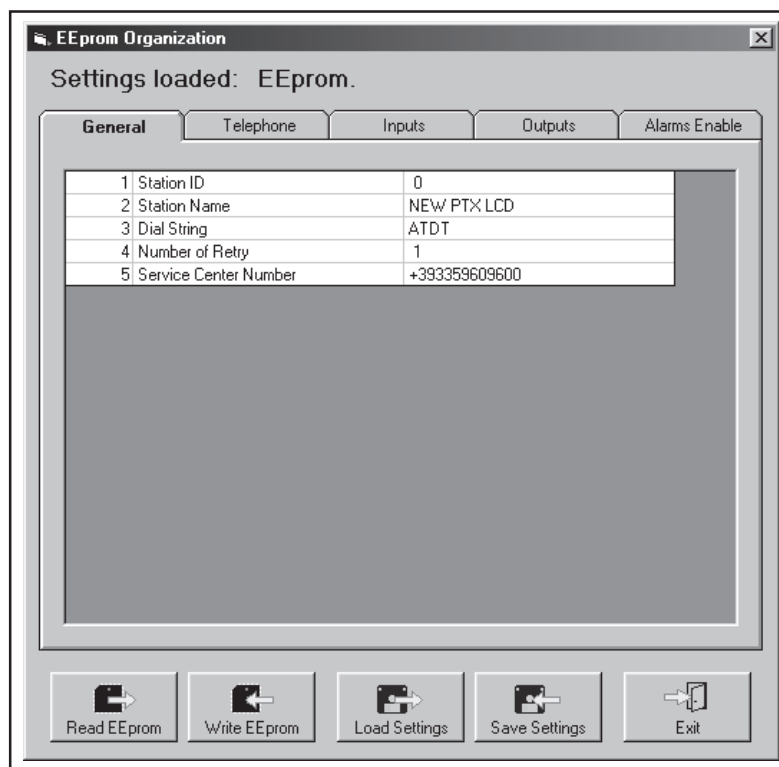

Now select the "Telephone" data category and set the following:

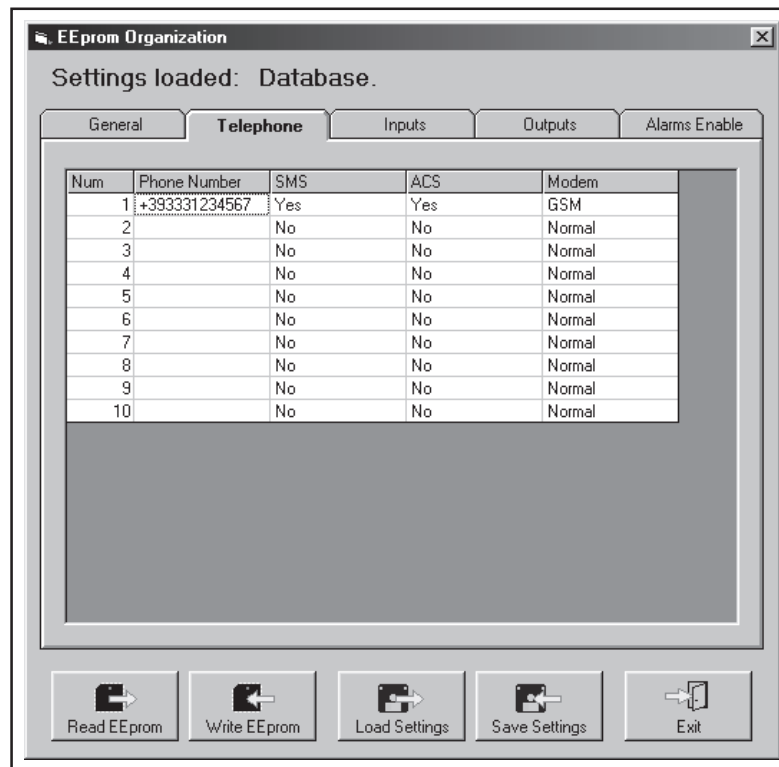

Settings loaded: Database.

General **Telephone** Inputs Outputs Alarms Enable

Num	Phone Number	SMS	ACS	Modem
1	+393331234567	Yes	Yes	GSM
2		No	No	Normal
3		No	No	Normal
4		No	No	Normal
5		No	No	Normal
6		No	No	Normal
7		No	No	Normal
8		No	No	Normal
9		No	No	Normal
10		No	No	Normal

Read EEPROM Write EEPROM Load Settings Save Settings Exit

- **PHONE NUMBER:** GSM phone numbers recognised by the station to which you want the alarms sent;
- **SMS:** select "YES" to enable transmission of SMS commands to system;
- **ACS:** select "YES" to enable SMS reception;
- **MODEM:** select "GSM".



Note: For correct transmission, place country code (+XX) before set numbers.

Eight customised programmable alarms can be set if the optional telemetry card is installed.

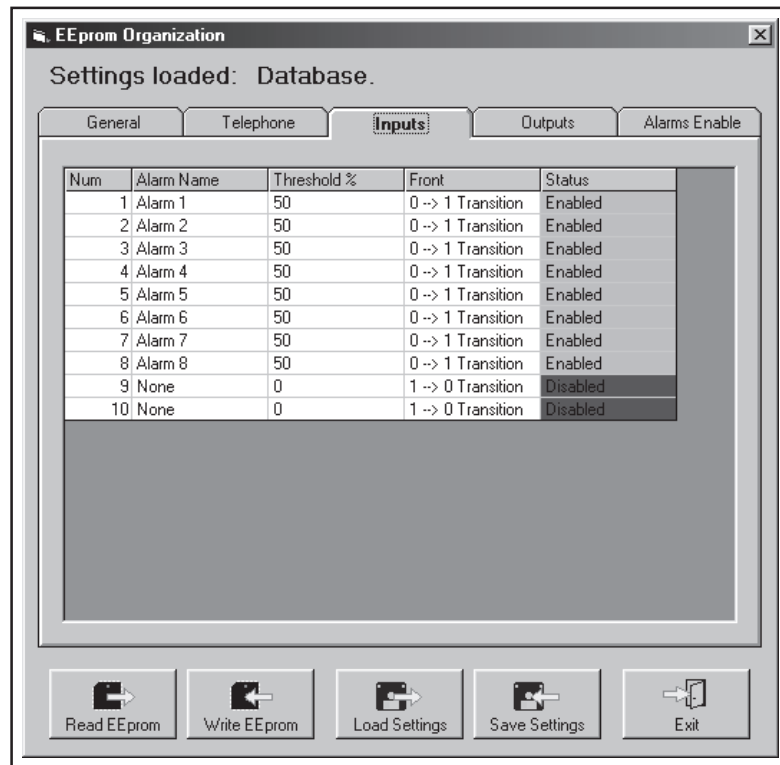

- **ALARM NAME:** Name of alarm sent with SMS (max 20 characters);
- **THRESHOLD:** Alarm activation threshold in percent;
- **FRONT:**
 - 0-->1** Alarm is activated if signal exceeds set threshold
 - 1-->0** Alarm is activated if signal drops below set threshold;
- **STATUS:**
 - Enable** Enable Alarm reporting enable
 - Disable** Disable Alarm reporting disable



When all parameters are set, press this key and the **PTX-LCD** will store the information.

When finished, click "Exit" to exit the remote station programming window.

Back into "TELECON" standard interface, click the "General" measurement selection button to set thresholds and operation times for the various alarms according to the principles outlined in Section "Alarm Management".



Note: When setting alarm thresholds, allow a margin of some percent points with respect to normal operation parameters.



Note: When the configurations are completed, do not forget to connect the GSM modem to the **PTX-LCD** using the supplied cables; the following block diagram and picture are for your reference:

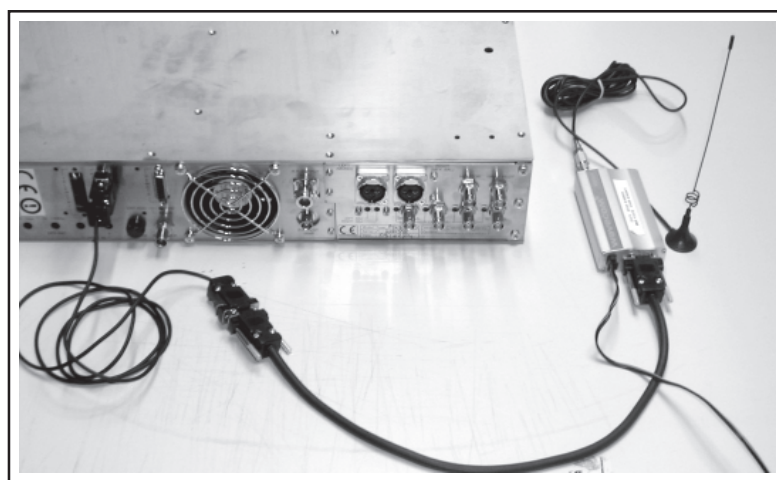
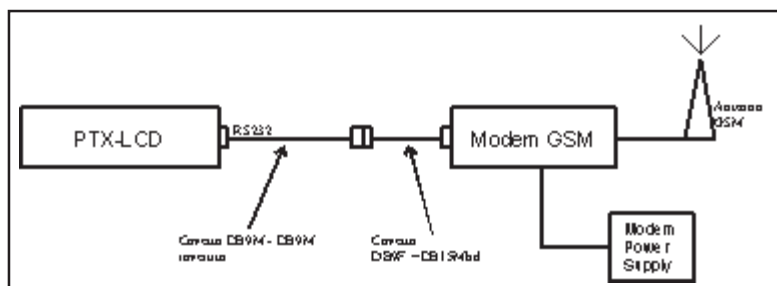

9.3 Remote Control

All **PTX-LCD** parameters can be monitored on a PC with a suitable modem connection.

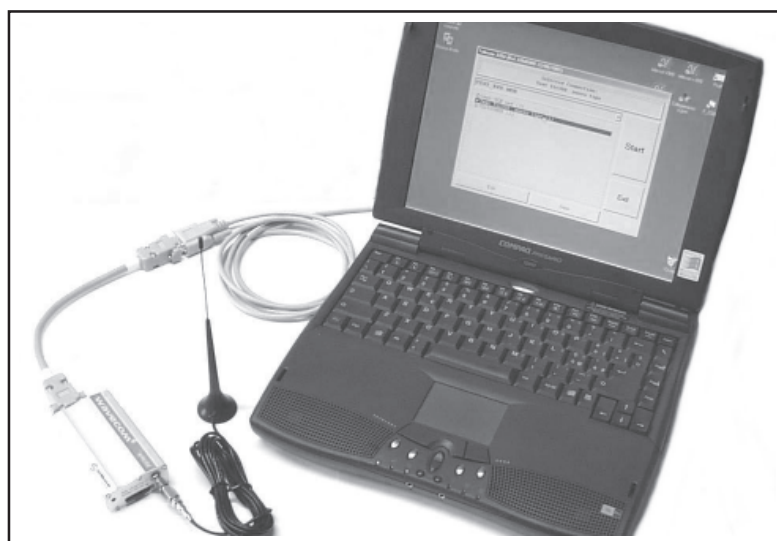

The "TELECON" software establishes connection with the station through a phone line or GSM modem and enables the following remote operations: alarm reset, transmitter switch on/switch off, output power reduction, dummy load testing, etc., data evaluation to locate possible faults, identification of parts required for repair.

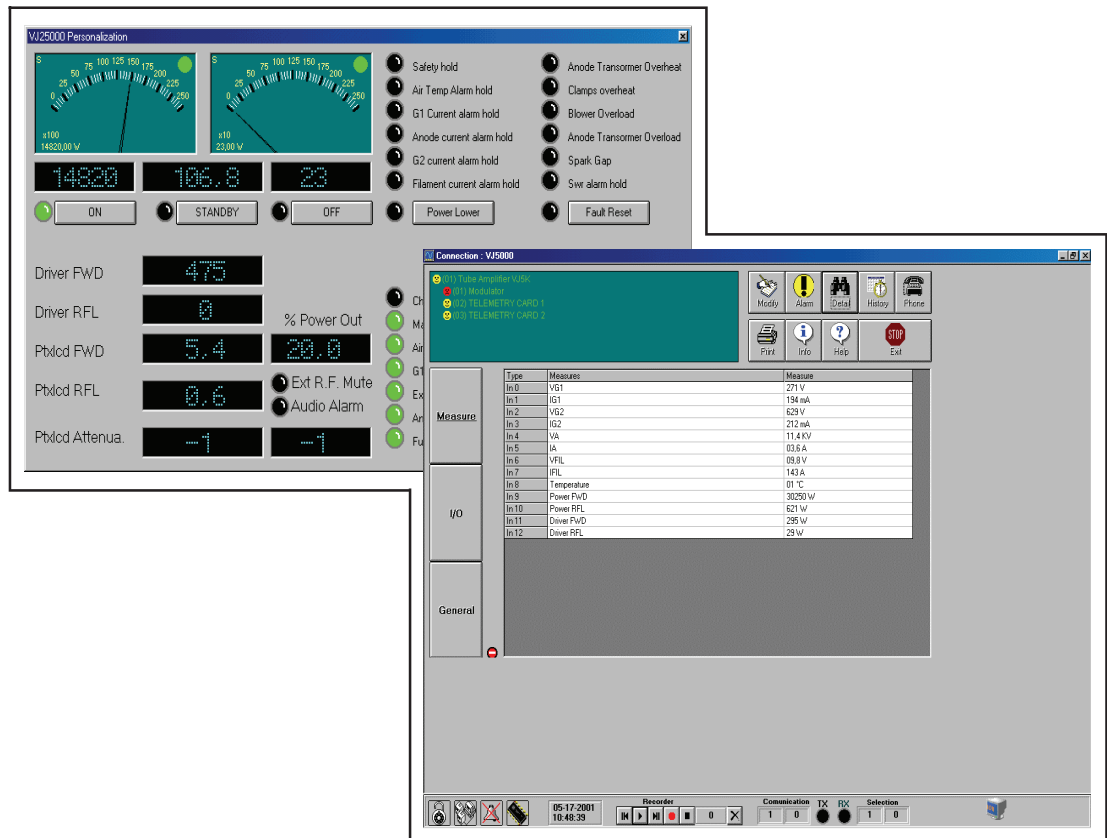

9.4 Internal Modem (Option /GSM)

With this option, all operations listed above can be performed via the modem built into the exciter.

When the configurations are completed, do not forget to connect the integrated GSM modem to PTX-LCD using the supplied cable as shown in the picture:

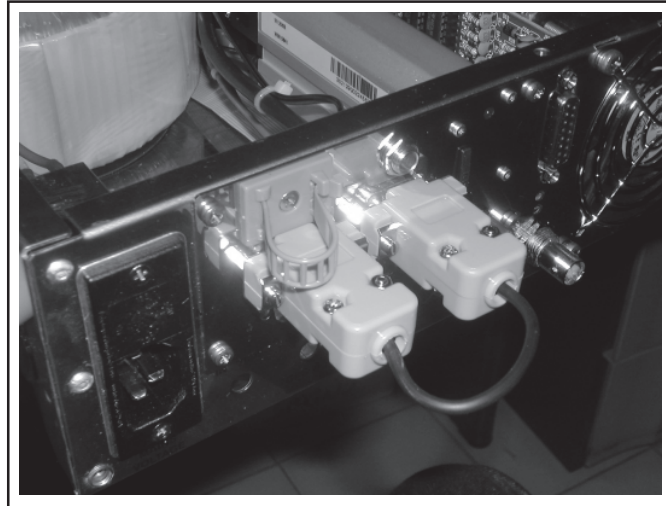

Note: The RS232 and MODEM connectors are connected to each another by factory. However, they may also be used independently (for example, RS232 connector for factory parameter programming and MODEM connector for GSM modem connection to PC).

10. Technical Specifications

10.1 Mechanical Specifications

Panel size	483 mm (19") x 88 mm (3 1/2") (2 HE)	
Depth	344 mm (26 1/2")	
Weight	PTX30	13 Kg
	PTX60	15.5 Kg
	PTX100	15.5 Kg
Operating temperature	-10 °C ÷ 50 °C	

10.2 Electric Specifications

General

RF output power	PTX30LCD:	0-30 W, adjustment with continuity
	PTX60LCD:	0-60 W, adjustment with continuity
	PTX100LCD:	0-100 W, adjustment with continuity
RF output connector	type "N"	
RF output impedance	50 Ohm	
Frequency band	87.5 MHz ÷ 108 MHz	
Frequency programming	direct via software	
Frequency stability	±1ppm from -10 °C to 50 °C	
Type of modulation	direct carrier modulation	
Spurious and harmonic suppression	meets or exceeds FCC and CCIR standards (typically, 85 dB)	
Modulation capacity	meets or exceeds FCC and CCIR standards (typically, 240kHz for MPX or Mono, 210 KHz for Stereo)	
Residual asynchronous AM modulation	-70 dB or less with respect to 100% AM, without deemphasis	
Residual synchronous AM modulation	-60 dB or less with respect to 100% AM, 75KHz FM modulation at 400Hz, without deemphasis	
Transient intermodulation distortion	< 0.1% (typically, 0.05%) measured with square waveform at 3.18 kHz and sinusoidal waveform at 15 kHz with 75 kHz FM	
Power supply	115÷125 V, 50÷60 Hz 230÷250 V, 50÷60 Hz	
Absorption	PTX30LCD	approx. 120 VA
	PTX60LCD	approx. 200 VA
	PTX100LCD	approx. 300 VA

Inputs

Left/Mono-Right/MPX inputs	Female XLR type, balanced or unbalanced
MPX input	BNC type, unbalanced
Input impedance	10 KOhm or 600 Ohm, software selectable
Input level	-13 dBm ÷ +14 dBm adjustable in 1 dB steps via software, fine tuning with continuity by trimmer

Preemphasis	selectable:	0 25 us 50 us (CCIR) 75 us (FCC)
SCA/RDS inputs		3 unbalanced BNC connectors
SCA input impedance		10 KOhm
SCA input level		-20 dBm ÷ +10 dBm, adjustable by trimmer
SCA amplitude/frequency response		± 0.2 dB, from 40 KHz to 100 KHz
67KHz subcarrier crosstalk on main or stereo channels		65 dB
92KHz subcarrier crosstalk on main or stereo channels		70 dB

Outputs

MPX Monitor:		0 dBm for 75KHz FM minimum load 600 Ohm
19 KHz pilot tone		1 Vpp minimum load 4.7 KOhm
RF Test		-30 dB referred to RF output impedance 50Ohm

MONO operation

FM S/N		> 82dB (typically 90 dB) referred to 75KHz measured in 20 Hz band ÷ 20 KHz with 50 us deemphasis, RMS detector
Amplitude/frequency response		± 0.5 dB, 20Hz ÷ 15KHz
Total Harmonic Distortion (THD)		< 0.02%
Intermodulation distortion		< 0.02% measured with 1 kHz and 1.3 KHz tones, 1:1, 75 kHz FM modulation

MPX operation

Composite FM S/N		> 82dB (typically 90 dB) referred to 75KHz measured in 20 Hz band ÷ 100 KHz with 50 us deemphasis, RMS detector
MPX amplitude/frequency response		± 0.05 dB, 20 Hz ÷ 53 KHz ± 0.2 dB, 53 KHz ÷ 100 KHz
MPX total harmonic distortion		< 0.02%
Intermodulation distortion		< 0.02% measured with 1 KHz and 1.3 KHz tones, 1:1, 75 kHz FM modulation
Stereo separation		> 50 dB (typically 60dB)

Stereo Operation

Stereo FM S/N		> 82dB (typically 90 dB) referred to 75KHz measured in 20 Hz band ÷ 100 KHz with 50 us deemphasis, RMS detector
Audio amplitude/frequency response		± 0.5 dB, 20Hz ÷ 15KHz
Total harmonic distortion		< 0.03%
Intermodulation distortion		< 0.03% measured with 1 kHz and 1.3 KHz tones, 1:1, 75 kHz FM modulation
Stereo separation		> 50 dB (typically 60dB)

Remote connections

Remote connector	Female DB15 type; provides: FWD and RFL inputs for external AGC 6 analogue or digital inputs 2 relay digital outputs
Interlock connector	BNC, for power disable
I ² C interface	
Serial interface	Female DB9 RS232, DTE or DCE selectable RS485 (Option) DTE or DCE selectable
Telemetry card Option	Female DB25 type 8 analogue/digital inputs 2 digital outputs 1 I2C serial interface

Options

/03	24V External Battery
/08	Telemetry interface
/AUDIOINP-DIG	Digital audio input interface
/TRDSP	Digital and analogue audio input interface, DSP technology, integrated Digital Stereo Coder, integrated RDS Coder
/GSM	Integrated GSM Modem

AUDIOINP-DIG

D/A converter	24 bit
Sampling frequency	from 32 to 96 KHz
Data format	S/PDIF, AES/EBU, IEC958 and EIAJ CP340/ 1201
Digital inputs	1 unbalanced input for coaxial cable with PIN/ RCA connector (S/PDIF) 1 fiber optics TOSLINK 1 XLR balanced female connector (AES/EBU)
Emergency switch	3.5mm JACK; connected to ground, forces audio input selection

TRDSP

ANALOGUE AUDIO INPUT

Conversion	24 bit
Connector	XLR, electronically balanced
Impedance	600/10K - adjustable via software
Input level	Adjustable via software
Maximum input level	6/18/30 dBu

DIGITALAUDIO INPUT

Connector	Balanced XLR + optical TOS-LINK
Data format	AES/EBU - S/PDIF - EIAJ-340
Sampling frequencies	from 32 to 96 KHz

DIGITALAUDIO OUTPUT

Connector	PIN – RCA Unbalanced
Data format	S/PDIF
Sampling frequencies	96 kHz

MPX OUTPUT

D/A conversion	24 bit
Pilot Tone	19 KHz ± 0.5 Hz
Pilot level	Selectable
Pilot phase	Selectable
Subcarrier attenuation 38 KHz	min. -90 dB
MPX output level	Selectable
Stereo separation	65 dB, 30 Hz - 15 kHz
MPX output noise	-90 dBu
Preemphasis	50/75 microsec.
Preemphasis error	± 0.01 dB, 30 Hz - 15 kHz
15 kHz low-pass filter ripple	± 0.01 dB, 30 Hz - 15 kHz
Low-pass filter 19 KHz attenuation	-90 dB
Clipper	Right and left channel + MPX
AGC	Left and right channel

RDS

Cenelec 50067	Specification (PI: Program Identification, PS: Program Service, PTY: Program Type, TP: Traffic Program Identification, TA: Traffic Announcement, AF: Alternative Frequencies, M/S: Music/Speech, PIN: Program Item Number, RT: Radio Text, EON: Enhanced Other Networks, TDC: Transparent Data Channel, IH: In-house Application)
Subcarrier frequencies	57 kHz ± 1.5 Hz
Synchronisation	Internal or external

ELABORATION

A/D conversion	24 bit
D/A conversion	24 bit
DSP elaboration	32 bit

11. Factory Settings

Each time a change is made to a **PTX-LCD** parameter, the new setting is added to machine configuration information, which is stored in a non-volatile memory area. On switch on, the exciter will retain the same configuration it had been using before the last switch off.

At the factory, the exciter may be set to meet application-specific requirements (for example, when the customer specifies operating frequency and mode of operation of the system the exciter is to be incorporated into on order), or to a preset configuration.

The **PTX-LCD** preset configuration is determined by the position of a set of jumpers located inside the machine. When the exciter is switched on, the name of the selected preset configuration appears on the display (see 7.1).

Possible configurations are as follows:

CCIR

Parameter	Menu	Value
Power Output	Preset	On
Minimum frequency	/	87.5 MHz
Maximum frequency	/	108.0 MHz
Frequency step	/	10 kHz
Preset frequencies	Admin-ExFrq	87.5, 90.0, 92.0, 94.0, 96.0, 98.0, 100.0, 102.0, 104.0, 106.0 MHz
Power	Preset	0 %
Input level Mono/L	Admin->AuSet->Mono/L X dBm	0 dBm
Input level MPX/R	Admin->AuSet->MPX/R X dBm	0 dBm
Input state Mono/L	Admin->AuSet->Mono/L X dBm	On
Input state MPX/R	Admin->AuSet->MPX/R	On
Preemphasis	Admin->BdSet->Preemph	50 μ s
Clipper	Admin->BdSet->Clipper	Off
Mode of operation	Admin->BdSet->Mode	Stereo (if stereo coder is present) MPX (if stereo coder is not present)
Pilot tone	Admin->StSet->Pilot	On (if stereo coder is present)
Phase difference btw Channels		Admin->StSet->Chan0 (if stereo coder is present)

FCC

Same as CCIR, except:

Parameter	Menu	Value
Preemphasis	Admin->BdSet->Preenph	75 μ s
Mode of operation	Admin->BdSet->Mode	Stereo (if stereo coder is present) Mono (if stereo coder is not present)

OIRT

Same as CCIR, except:

Parameter	Menu	Value
Minimum frequency	/	66.0 MHz
Maximum frequency	/	74.0 MHz
Preset frequencies	Admin-ExFrq	66.0, 67.00, 68.00, 68.00, 69.00, 70.00, 71.00, 72.00, 73.00, 74.00 MHz
Mode of operation	Admin->BdSet->Mode	Stereo (if stereo coder is present) Mono (if stereo coder is not present)

JAPAN

Same as CCIR, except:

Parameter	Menu	Value
Minimum frequency	/	76.0 MHz
Maximum frequency	/	90.0 MHz
Preset frequencies	Admin-ExFrq	76.0, 78.0, 80.0, 82.0, 83.0, 84.0, 85.0, 86.0, 88.0, 90.0 MHz
Mode of operation	Admin->BdSet->Mode	Stereo (if stereo coder is present) Mono (if stereo coder is not present)

ITALY

Same as CCIR, except:

Parameter	Menu	Value
Minimum frequency	/	87.6 MHz
Maximum frequency	/	107.9 MHz
Frequency step	/	100 kHz
Preset frequencies	Admin-ExFrq	87.6, 90.0, 92.0, 94.0, 96.0, 98.0, 100.0, 102.0, 104.0, 106.0 MHz
Clipper	Admin->BdSet->Preenph	On
Mode of Operation	Admin->BdSet->Mode	Stereo (if stereo coder is present) Mono (if stereo coder is not present)

C.S.I

Same as CCIR, except:

Parameter	Menu	Value
Minimum frequency	/	100.0 MHz
Maximum frequency	/	108.0 MHz
Preset frequencies	Admin-ExFrq	100.0, 100.5, 100.1, 101.5, 102.0, 103.0, 104.0, 105.0, 106.0, 108.0 MHz

12. Module Identification and Access

12.1 Module identification

The figure shows a top view of machine inner components. Component descriptions are listed below.

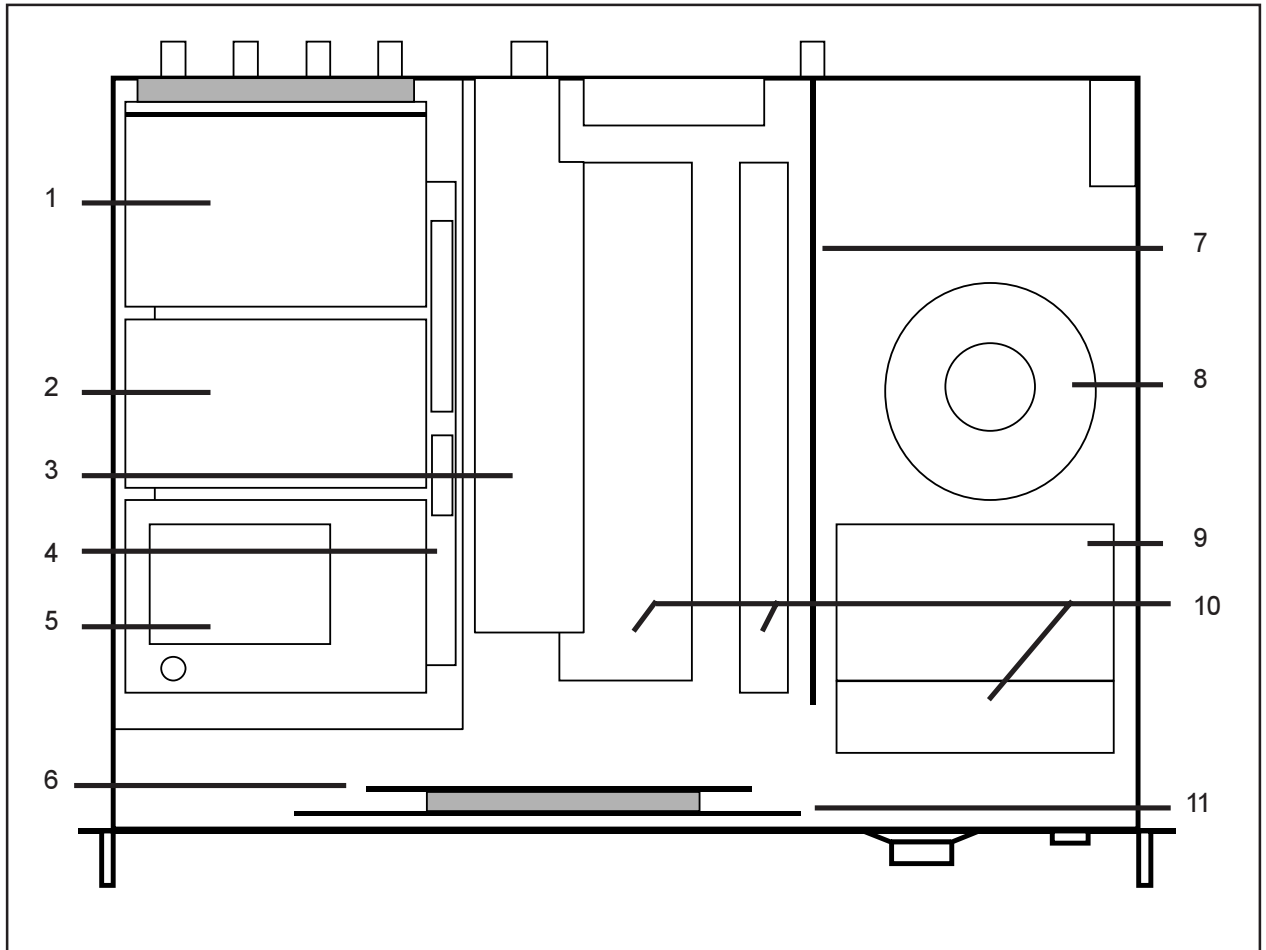

- [1] Audio Input card
- [2] Stereo Coder or mono card
- [3] RF power amplifier
- [4] Audio mainboard
- [5] PLL & VCO card
- [6] CPU Section (CPU Interface + 16Bit CPU card)
- [7] Power supply
- [8] Transformer
- [9] Switching power supply
- [10] Cooling fins
- [11] Panel card - display

12.2 How to access modules



WARNING: Dangerous voltages or currents inside! Be careful when opening the device. Always disconnect power supply before removing the covers or any device component.

Remove all screws on the top cover of the machine. Remove the cover and refer to the block diagram to identify and locate all exciter components.

To remove the (stereo or mono) coder and PLL cards, simply undo the hexagon nuts that secure the cards over the stud bolts. Both cards have strip connectors at the bottom and these connectors are coupled to the audio mainboard.

To remove the audio input card (which is secured to the audio connector card and to the right side of the exciter rear panel), undo the four nuts that retain the card to the audio mainboard stud bolts and then remove the five screws on the rear panel and the three bottom screws that retain the connector support.

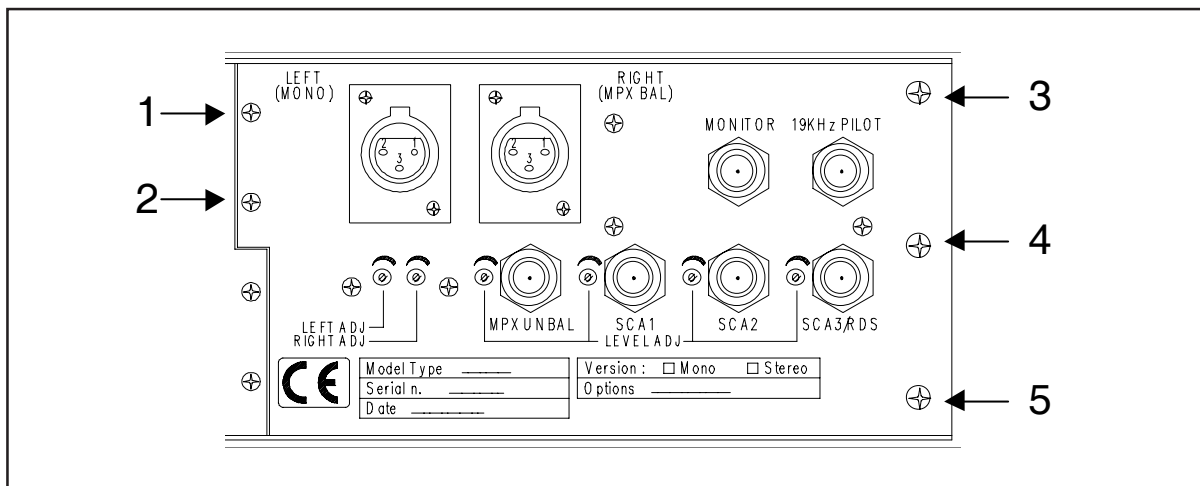

The RF power amplifier is secured to its cooling fin and is held in position by three screws located on exciter bottom. The screws hold the fin in place; remove these screws to release the amplifier.

Power supply and switching power supply use the same fastening system and can be released by removing the screws that secure the fins to machine bottom. Note, however, that the interlock connector soldered to the power supply is retained to the rear panel by a nut, and you will need to undo this nut before you can remove the power supply.

The panel card and the CPU card are held in place by nuts screwed onto the stud bolts. Detach the front panel from the box before removing these cards.

13. Operating principles

The figure below provides an overview of the **PTX-LCD** modules and connections.

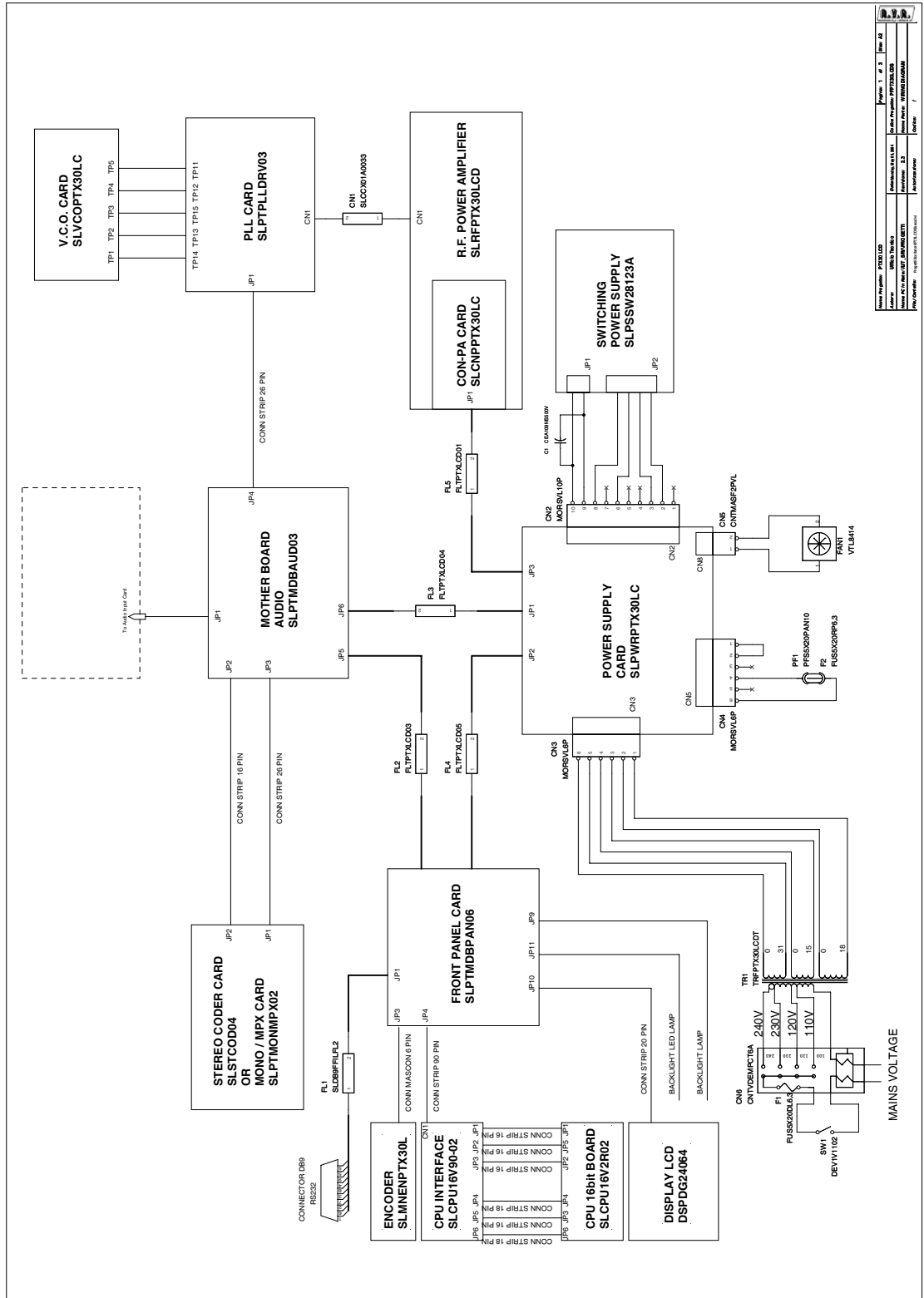

Following is a brief description of the different module functions.

13.1 Power Supply

There are two separate power supply sections.

A first section provides power supply for power final stage. It consists in a switching power supply unit mounted on a cooling fin.

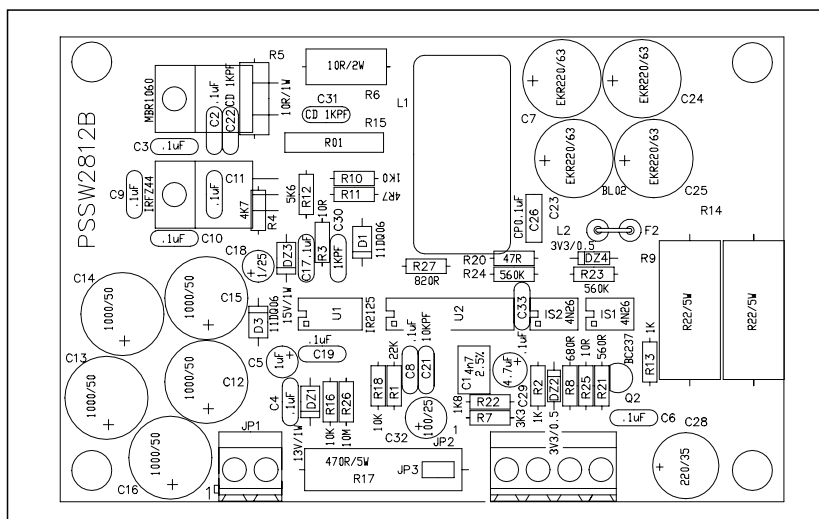

The second section consists in a card mounted on a heat sink located centrally in the machine. This card accommodates the power supply that feeds the different machine cards (audio, CPU...), a section that handles analogue inputs from the "Remote" connector and the automatic power level control system.

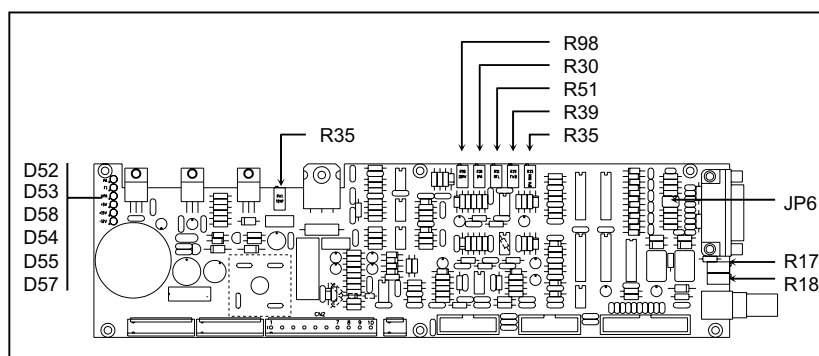

13.1.1 Adjustments, settings and indicators

While the switching power supply requires no adjustments, the power supply card accommodates several indicators and adjustable components.

- D52 on: power amplifier fuse fault
- D53 on: fuse PF1 fault
- D54 on: +5V present
- D55 on: +15V present
- D57 on: -12V present
- D58 on: supply voltage present at power supply section
- RV1 temperature sensor setting
- R17 level adjustment for external AGC
- R18 level adjustment for external AGC
- R30 PA current measurement adjustment

- R35 PA maximum current adjustment
- R39 forward power measurement adjustment
- R51 reflected power measurement adjustment
- R98 driver current measurement adjustment
- JP6 1-3, 2-4 the pins on the remote connector are used as analogue inputs
3-5, 4-6 the pins on the remote connector are used for IIC communication

13.2 Audio mainboard

This board provides an interface between audio section and PPL cards and the remaining exciter cards. The audio mainboard is secured to the left bottom section of the machine. The other cards are plugged to the connectors mounted on this board.

This module includes the circuit that mixes MPX signals and SCA/RDS subcarriers.

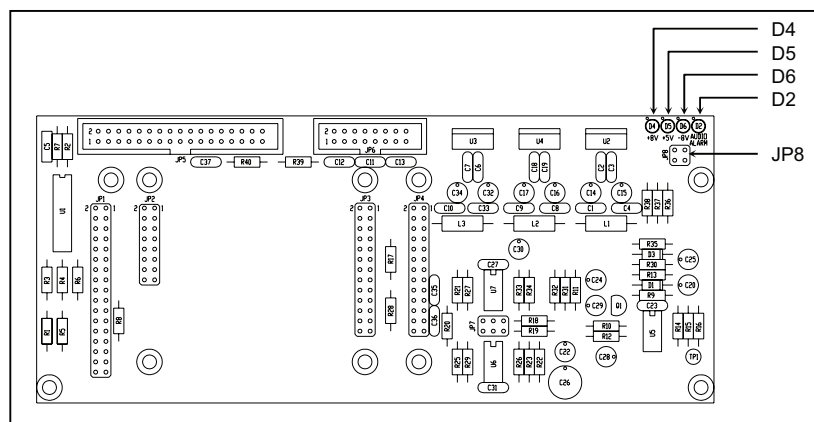

13.2.1 Adjustments, settings and indicators

- D2 on: audio missing alarm
- D4 on: voltage present
- D5 on: voltage present
- D6 on: voltage present
- JP8 factory setting - do not alter

13.3 Audio Inputs

The audio input section is located at the rear end of the machine and is connected directly to the audio mainboard through comb connectors. It is made up of two cards assembled at right angles to give an L-shaped pattern and secured to the rear panel section that accommodates the audio connectors.

The first card holds the level trimmers and the input filters. The second card includes level adjustments and audio configuration software control switches.

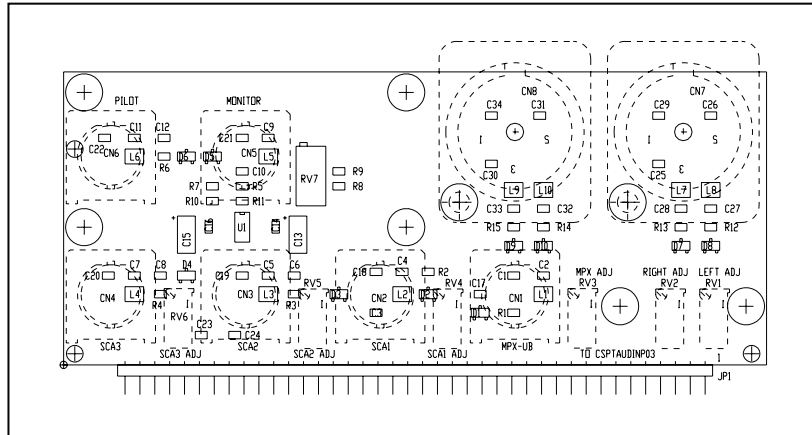

After the necessary elaboration (filtering, level adjustment, selection), the audio input section passes the signals on to the audio mainboard, that routes them to the coder card.

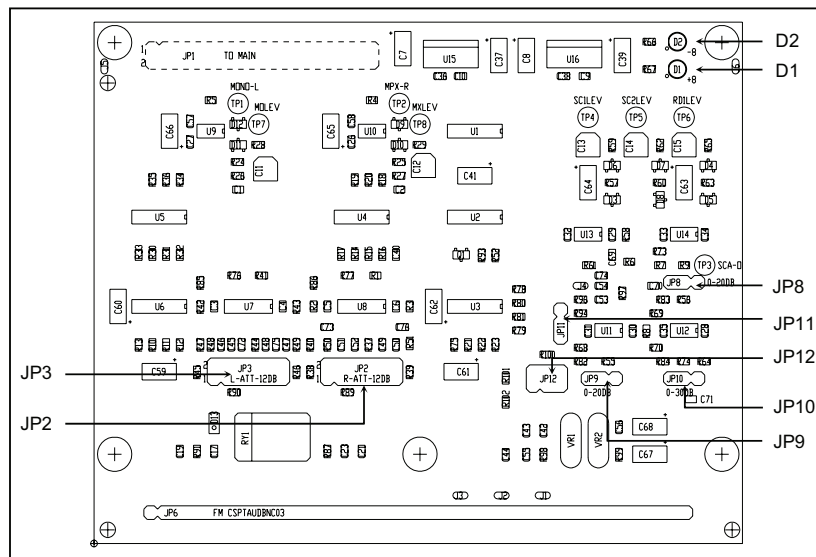

13.3.1 Adjustments, settings and indicators

- D2 on: power supply negative voltage present
- D1 on: power supply positive voltage present
- JP3 3-5, 4-6, 9-11, 10-12 no attenuation on input L
1-3, 2-4, 7-9, 8-10 12 dB attenuation on input L
- JP2 same as JP3, affects input R
- JP8 1-2 no gain on SCA2, 2-3 20 dB gain
- JP11 1-2 MPX_U input impedance 50 Ohm, 2-3 10 kOhm
- JP10 1-2 no gain on SCA3, 2-3 30 dB gain
- JP9 1-2 no gain on SCA1, 2-3 20 dB gain
- JP12 3-5, 4-6 no attenuation on MPX input
1-3, 2-4 12 dB attenuation on MPX input
- RV7 MPX monitor output level adjustment

13.4 Coder

The coder card is mounted above the mainboard between the audio input card and the PLL & Driver card.

This card comes in two versions, namely Stereo and Mono/MPX. The only difference between a Stereo **PTX-LCD** and a Mono/MPX **PTX-LCD** lies in the coder module.

Depending on the version, this card accommodates the low-pass filters, the preemphasis circuits, the stereo coder and the Clipper circuit, which may be enabled or disabled via software.

The Clipper circuit is mandatory in some countries; its purpose is to limit modulation level when audio inputs exceed nominal level.

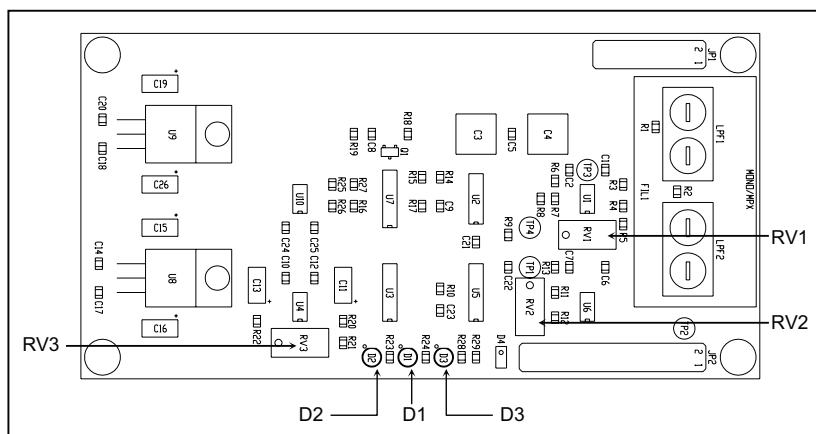
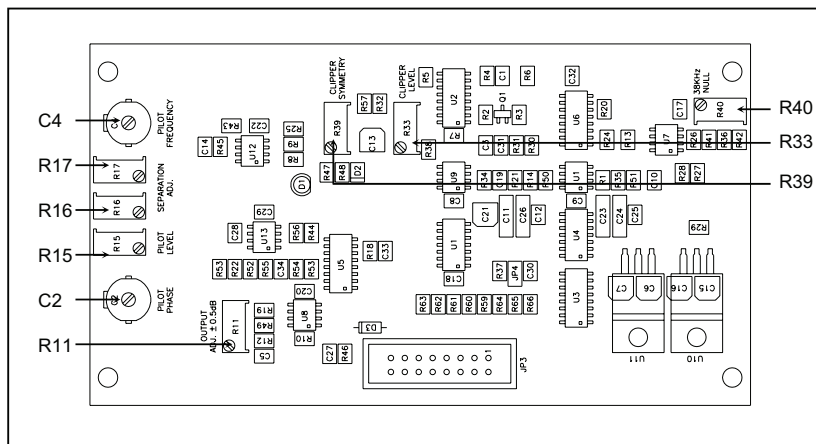

13.4.1 Adjustments, settings and indicators

Stereo Coder

C2	pilot tone phase
C4	pilot tone frequency
R11	stereo coder card output level
R15	pilot tone level
R16	stereo separation optimisation - left channel
R17	stereo separation optimisation - right channel
R33	clipper circuit operation level
R39	clipper circuit operation symmetry adjustment
R40	optimisation of 38 kHz subcarrier suppression

Mono/MPX card

LP1	low-pass filter 1
LP2	low-pass filter 2
RV1	mono level
RV2	mono coder card output level (deviation)
RV3	clipper circuit operation level
D1	power supply positive voltage presence
D2	power supply negative voltage presence
D3	clipper operating indication

13.5 PLL/Driver card & VCO Card

The PLL/Driver card is located on the left side of the **PTX-LCD** and is plugged into the audio mainboard.

The digital PLL module consists of a high-stability oscillator with temperature control and a digital circuit that divides and compares operating frequency. The oscillator generates a 10 Mhz frequency that is divided to give a fixed 1 kHz signal.

This signal is sent to the digital comparator/divider circuit that compares it to the VCO output signal, which has been divided according to exciter operating frequency.

The comparator AFC output signal is sent to to the varicap diodes mounted on the VCO card and added to the audio signal provided by the Coder card.

The Voltage Controlled Oscillator (VCO) generates the signal on exciter operating frequency; this signal is amplified up to about 300mW (25dBm), which is the necessary level to pilot the R.F. Power Amplifier block.

Note: The VCO card is housed in a silver-plated brass box secured to the PLL & Driver card.

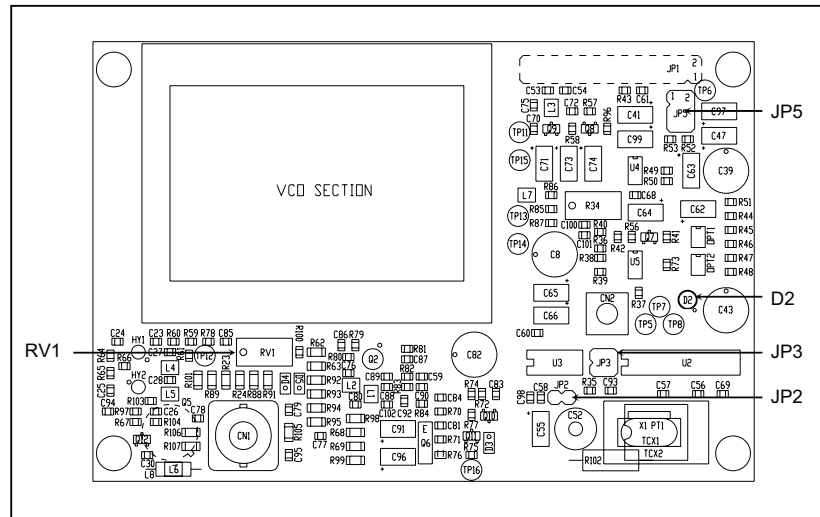

13.5.1 Adjustments, settings and indicators

- D2 on: PLL not locked
- RV1 bias adjustment
- JP2 factory setting - do not alter
- JP3 factory setting - do not alter
- JP5 factory setting - do not alter

13.6 Power amplifier

The power amplifier is available in a 30W and a 60/100W version.

Final power stage is secured to a heat-sink fin in the centre of the device and housed in a fully shielded metal enclosure secured to the central section of the equipment.

The R.F. signal from the PLL/DRIVER CARD, which is about 200mW, reaches the pilot (MRF237, class C), is amplified up to about 1.5W and sent to the final stage (BLF245) that finally amplifies up to 30W.

The resulting signal is filtered by a low-pass filter to remove harmonic components.

A directional coupler located inside the final stage measures forward and reflected power of the load and sends the relating signals to the power supply for verification.

A -30dB level output for output power is available on a BNC connector located on the rear panel, under the transmitter output connector.

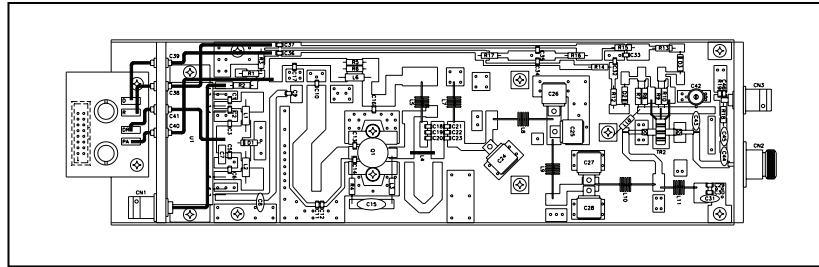
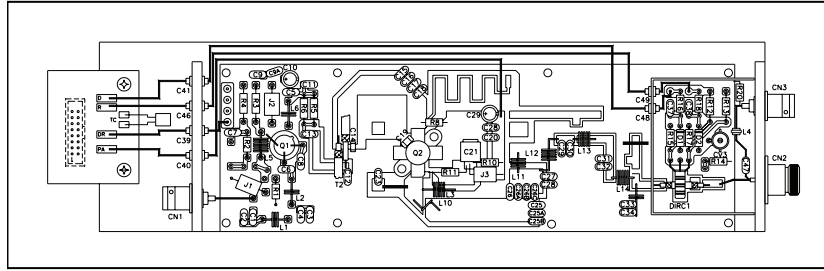

13.7 Panel Card

This card is located in the front end of the device and provides an interface between the CPU card and the remaining **PTX-LCD** cards.

This card handles all signals from/to LCD, Encoder, LED Indicators, Power Supply Card, Audio Mainboard and external telemetry card, in other words, all input/output signals of the CPU card.

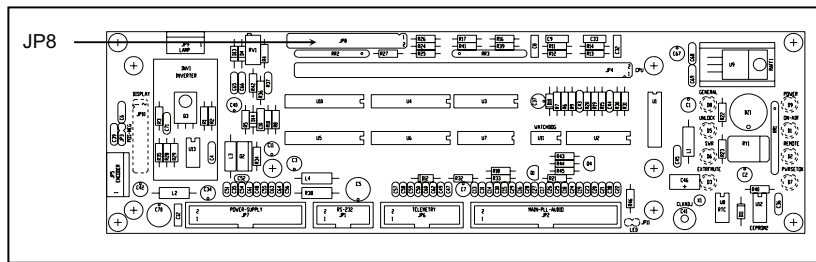

13.7.1 Adjustments, settings and indicators

JP8 Position of panel card jumpers.

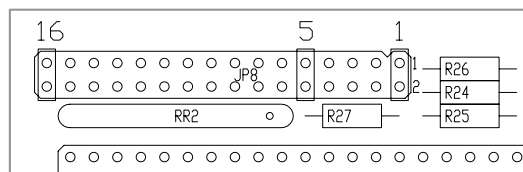

The software denotes jumper positions as follows (1 signifies a closed jumper, 0 open jumper, X any position):

Jump 5	Jump 6	Jump 7	Jump 8	Jump 9	Jump 10	Jump 11	Jump 12	Jump 13	Jump 14	Meaning
0	0	X	X	X	X	X	X	X	X	ExPwr, ExSts and ExFrq menu disabled
1	0	X	X	X	X	X	X	X	X	ExPwr and ExSts menu enabled, ExFrq menu disabled
0	1	X	X	X	X	X	X	X	X	ExPwr and ExSts menu disabled, ExFrq enabled
1	1	X	X	X	X	X	X	X	X	ExPwr, ExSts and ExFrq disabled
X	X	0	0	0	X	X	X	X	X	Default parameters set in case of exciter reset: CCIR for PLL at 10MHz
X	X	1	0	0	X	X	X	X	X	Default parameters set in case of exciter reset: FCC
X	X	0	1	0	X	X	X	X	X	Default parameters set in case of exciter reset: OIRT
X	X	1	1	0	X	X	X	X	X	Default parameters set in case of exciter reset: Japan
X	X	0	0	1	X	X	X	X	X	Default parameters set in case of exciter reset: Italia
X	X	1	0	1	X	X	X	X	X	Default parameters set in case of exciter reset: CSI
X	X	0	1	1	X	X	X	X	X	Reserved for future applications
X	X	1	1	1	X	X	X	X	X	Reserved for future applications
X	X	X	X	X	1	X	X	X	X	MAINS alarm enabling. NOTE: in this case is necessary to move the two jumpers from positions 3-5 and 4-6 to the positions 1-3 and 2-4, of Supply card JP6 jumper (see fig. below)
X	X	X	X	X	X	1	X	X	X	TRDSP optional card presence
X	X	X	X	X	X	X	1	X	X	13 MHz Quartz frequency on PLL card
X	X	X	X	X	X	X	X	1	X	Telemetry optional card presence
X	X	X	X	X	X	X	X	X	1	SPN software version (only for TRDSP)

- 1) In case of **ExFrq enabled** is necessary to modify the jumper JP6 on power supply, as indicated in the following figure, in order to enabled the alternatives frequencies that shall be used when the exciter is used as backup in a N+1 system.
- 2) In case of **MAINS alarm enabled** is necessary to modify jumper the JP6 on power supply, as indicated in the following figure, in order to validate the activation of the alarm.

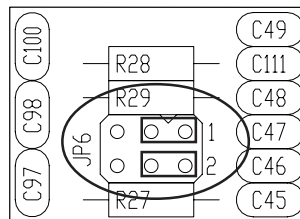

Example relating to MAINS ON on power supply card

13.8 CPU card (16-bit)

The CPU card is located at the front end of the device and is secured to the panel card.

This card is the heart of the transmitter as it handles and processes all information provided by the other cards and by other devices connected through the serial interface or the telemetry card.

The 1Mb Flash Memory enables firmware update through direct connection of **PTX-LCD** RS232 output to the serial port of a PC.

Card specifications are as follows:

- **Microprocessor:** 90F5436
- **Flash Memory size:** 1MBytes
- **Static RAM size:** 32KBytes
- **Communication Interface:** RS232-RS485 and I²C Bus
- **EEPROM size:** 2KBytes
- **Self-diagnosis LED:** 1 red led

The card requires no settings or adjustments.

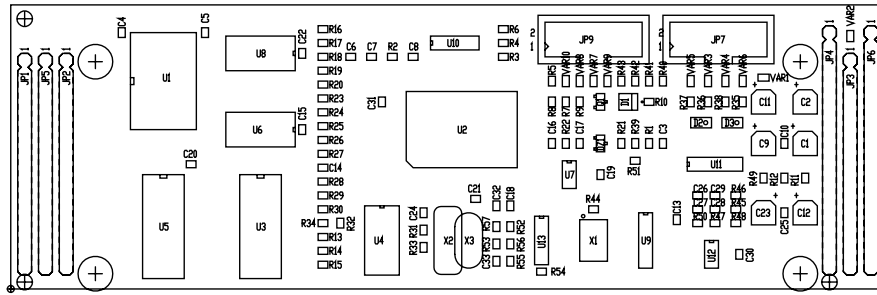

13.9 Telemetry card “SLTELEM00001” (optional)

This card has a female DB25 connector that can be accessed on the machine rear panel.

This card provides 8 programmable customized alarms that are discussed in paragraph 9.1.

This card enables user access to "TELEM" Menu measurements and controls. It can measure 8 analogue inputs from 0 to 5 V; it also controls two digital outputs that use relay contacts and an open-collector digital output.

The card requires no settings or adjustments.

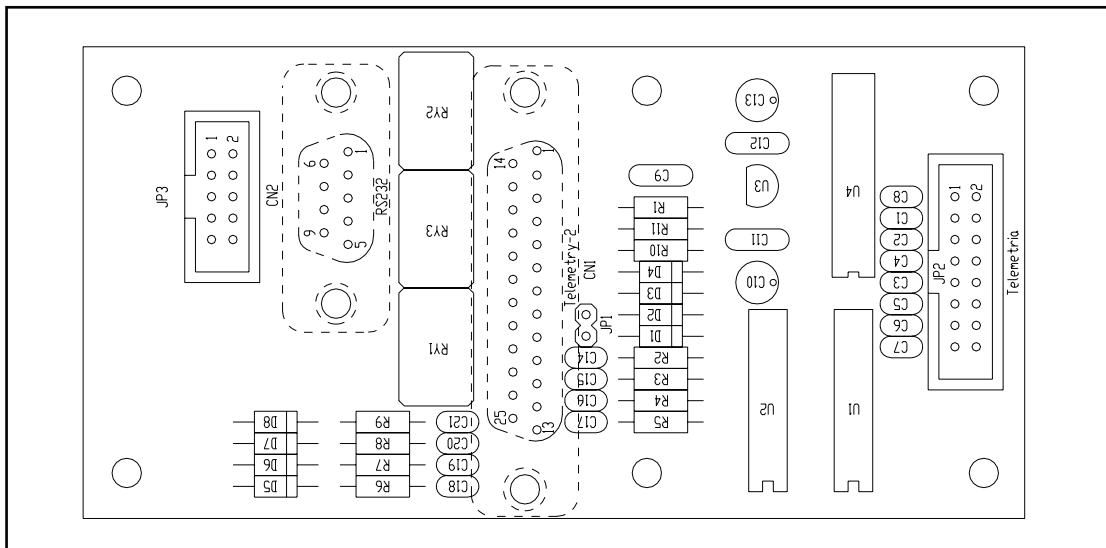

13.9.1 Telemetry

This optional menu displays the state of the optional add-on telemetry card.

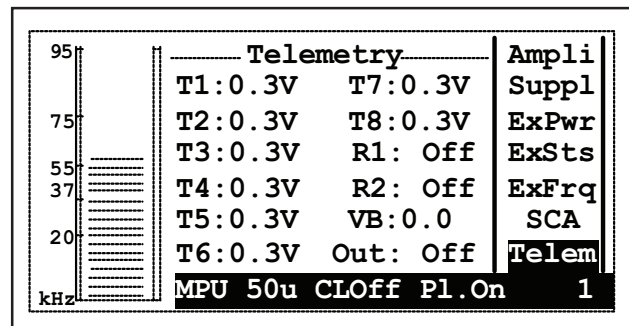

If the telemetry is not fitted, displayed values are not applicable. If the relevant option is installed (and the card 25-pin connector is fitted at the rear of the machine), the fields have the following meanings.

T1	voltage on pin 9 of telemetry card input connector.
T2	voltage on pin 22 of telemetry card input connector.
T3	voltage on pin 10 of telemetry card input connector.
T4	voltage on pin 23 of telemetry card input connector.
T5	voltage on pin 11 of telemetry card input connector.
T6	voltage on pin 24 of telemetry card input connector.
T7	voltage on pin 12 of telemetry card input connector.
T8	voltage on pin 25 of telemetry card input connector.
R1	service relay 1 enable/disable.
R2	service relay 2 enable/disable.
VB	battery supply voltage (only if optional 24 volts card is fitted).
OUT	supplemental service output (to control an external circuit).

13.10 Telemetry card "SLTELEM00002" (optional)

The customized **PTX-LCD** version is supplied with telemetry card SLTELEM00002 as standard; this card provides a parallel interface similar to that of other RVR Elettronica devices (PJ series amplifiers, HC series couplers).



The Pin 13 of the DB25 connector signifies "RF Enable" (interlock) and must be closed to ground to enable machine power output. Normally, this is accomplished by using an optional external "Power Good" card, device ESTX300, or a simple DB25 connector with pin 13 closed to ground (pin 3, 7 or 21).

13.10.1 TLC/TLS

When the telemetry card "SLTELEM0002" is used, the following menu is enabled.

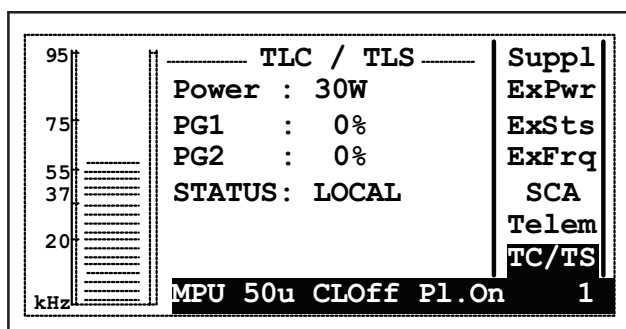

Power This line provides a settable software limit for the **PTX-LCD** maximum output power. Available options are "100 W" (no limit) and "30 W" (maximum PTXLCD output nearly 30 W).

PG1 Threshold level for "Power good 1" signal. Level is expressed in percent of set power level. Output PG1 of the telemetry card is on when **PTX-LCD** actual output power exceeds this percentage of set power. For example: Assuming that power set in the default menu is 70% of machine rated power ($70\% \times 100W = 70W$) and PG1 is set to 80% in the menu under discussion, the PG1 output at PIN 9 of the telemetry card will be on when actual output power exceeds $80\% \times 70W = 56W$.

PG2 Threshold level for "Power good 2" signal. Level is expressed in percent of set power level. Output PG2 at PIN 22 of the telemetry card is on when PTXLCD actual output power exceeds this percentage of set power. PG2 operates on the same logic as PG1.

STATUS Display and setting of the **PTX-LCD** mode of operation. "Local" or "Remote". When the machine is placed in "Local" mode, all settings included in the software are available (for example, frequency, power or audio levels), whereas the telemetry card inputs are inhibited. In the "Remote" mode, no changes may be made from machine menus (except returning to "Local" mode) and telemetry card inputs are enabled.

13.11 AUDINP-DIG Card (option)

The "/AUDINP-DIG" option permits to the **PTX-LCD** exciter the integration into systems using digital audio distribution.

This option is designed to replace the typical audio input section with no need for particular adjustments; no changes to exciter firmware (Releasexx04xxxx) are required after an update.

If present, a digital input will be automatically selected by the supplied logic.

Analogue (instead of digital) input selection can be forced using an external command.

A manual switch is available to choose between the balanced (AES/EBU) and unbalanced (TOSLINK and S/PDIF) digital input.

Two trimmers adjust converted digital input level to normalize R and L signals with respect to analogue input regulated level.

The D/A conversion is performed automatically by 24 bit converters using a sampling frequency from 32 to 96 KHz.

This option supports data formats S/PDIF, AES/EBU, IEC958 and EIAJ CP340/1201.

13.11.1 Functions description

The optional section is located in the **PTX-LCD** rear panel and is connected directly to the audio mainboard via a strip line connector. It includes three different cards.

The system provides for twelve cyclic system queries that enable quick fault location. If queries are not successful, a FAULT signal is sent to the CPU card that will take the necessary action to prevent additional faults.

The first card contains the balanced analogue inputs and the level trimmers for all analogue inputs and their filters; this is the same card used in PTX-LCD without AUDINP-DIG. The second card accommodates level adjustments and the software-based audio configuration switches. The third section helps convert the digital signal to "Left" and "Right" analogue signal and includes a matching level trimmer. This section also enables digital or analogue input selection: digital inputs are selected by default where fitted, whereas analogue inputs are selected using the Digital/Analog switch jack connector. A manual switch is available to choose between the balanced (AES/EBU) and unbalanced (TOSLINK and S/PDIF) digital input.

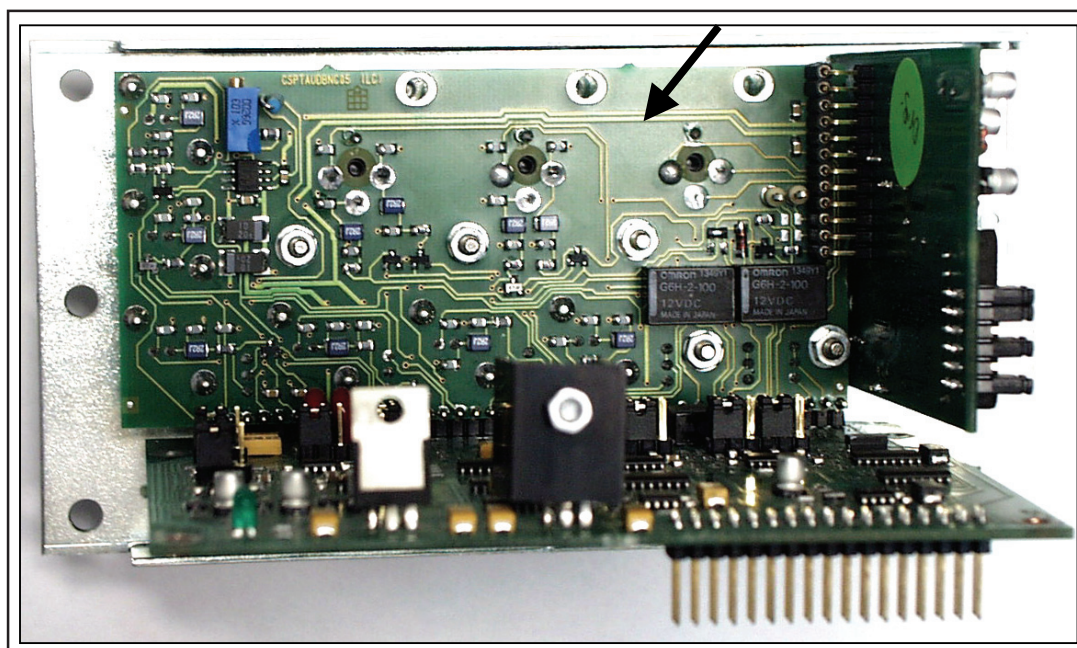

After the necessary elaboration (filtering, level adjustments, D/A conversion, selection), the audio input passes the signal on to the mainboard that routes it to the coder card.

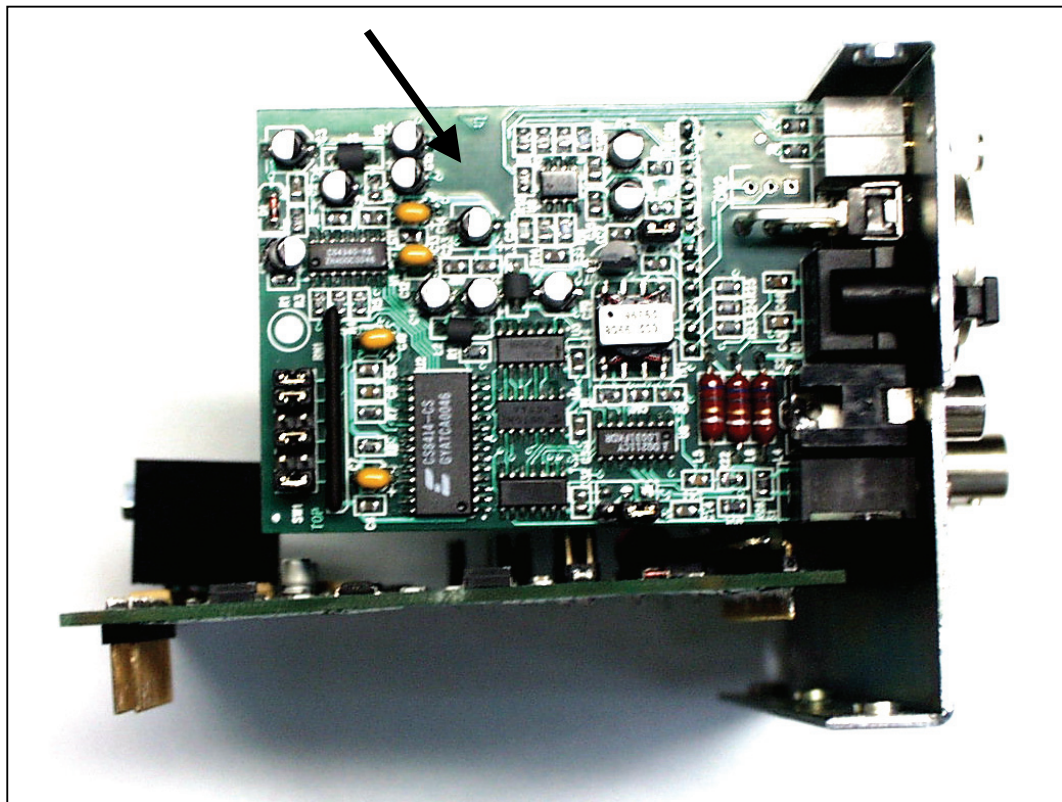
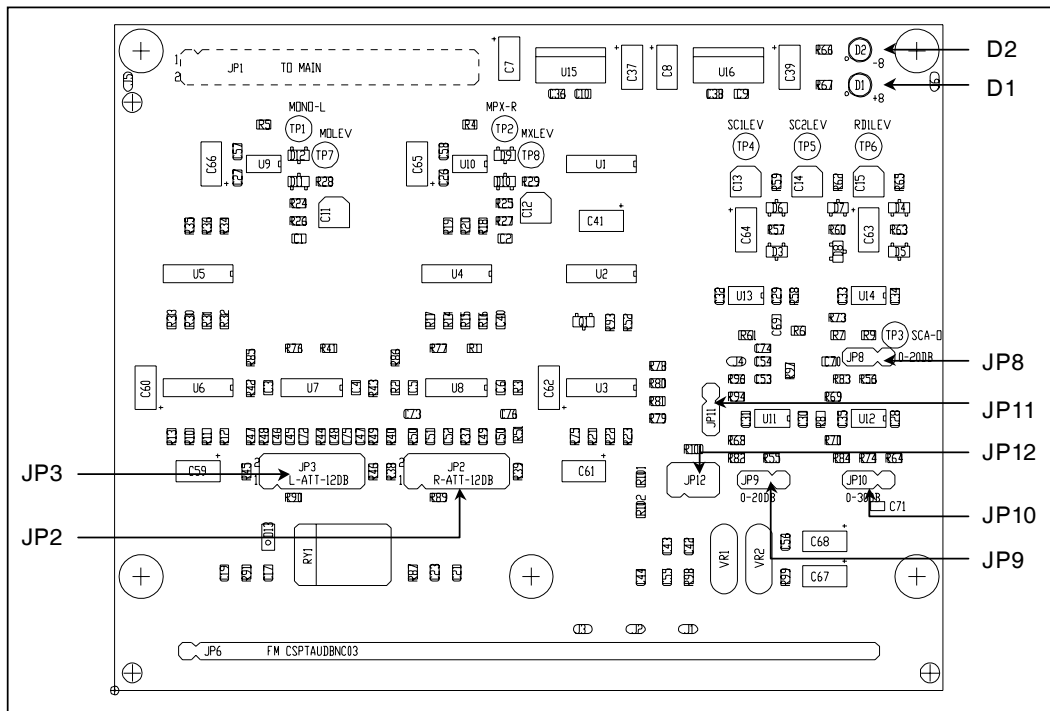

13.12 TRDSP card (optional)

Option TRDSP is a DSP-based digital circuit that performs the following tasks:

- input selection, level adjustment and processing (filtering and preemphasis)
- stereophonic coding
- RDS (Radio Data System) signal generation.

The TRDSP accepts audio inputs in digital form (AES/EBU) or Left and Right analogue inputs that are immediately converted into digital format (A/D). A digital input is automatically selected when present, but analogue input selection can be forced with the appropriate software settings.

The MPX stereophonic signal ("Main", "Sub" and 19 kHz subcarrier) is generated directly in digital form, starting with the Left and Right digital (or digitalised) channels.

The RDS is generated directly by DSP and then digitally added to the stereophonic audio signal. The messages transmitted by the RDS coder are programmed using a PC software supplied with the machine. It is also possible to disable the internal RDS coder and use an external coder.

The TRDSP option includes two electronic cards and a support panel with the input and output connectors. This subassembly is installed into **PTX-LCD** in place of the audio input and stereo coder sections (or Mono/MPX card). It can be easily retrofitted to standard **PTX-LCD** excitors.

The key advantage offered by the TRDSP option is enhanced performance in terms of:

- Amplitude/frequency response (± 0.01 dB, 30 Hz - 15 kHz)
- Stereophonic separation (65 dB, 30 Hz - 15 kHz)
- Distortion ($< 0.03\%$)

In addition, the digitally processed signal enables frequency deviation limitation while avoiding the distortion issues typically experienced with analogue clippers.

At TRDSP output, the total signal (MPX + RDS) is converted into analogue form (D/A) and passed on to the standard VCO/PLL section of **PTX-LCD**.

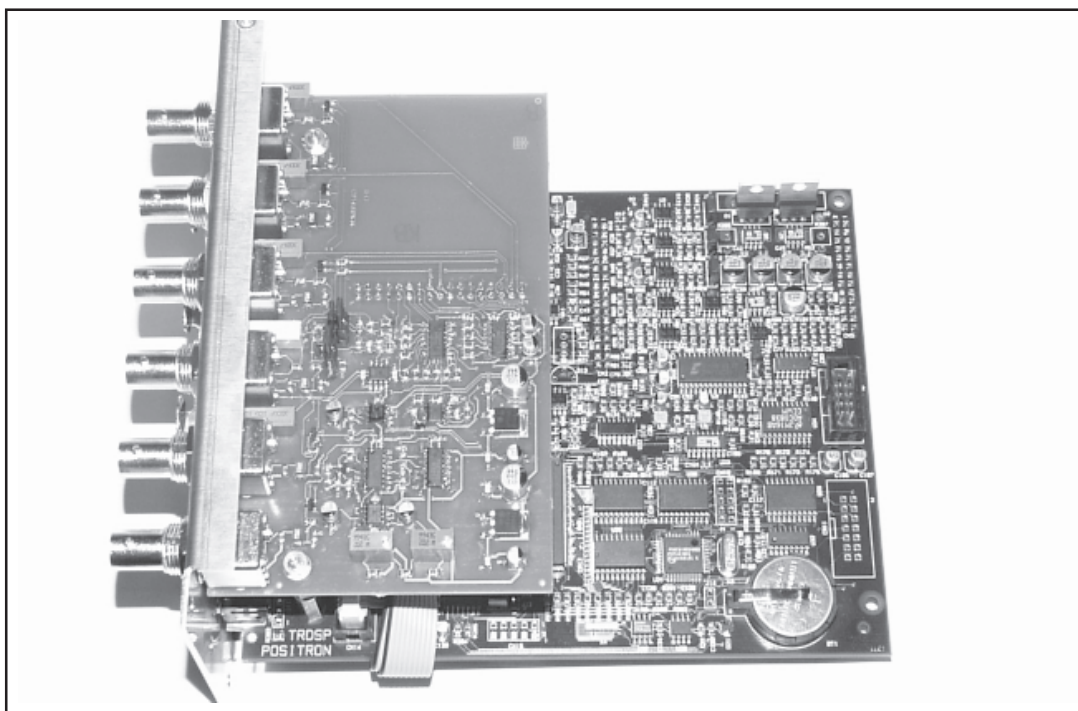

The block diagrams of a standard PTX-LCD exciter and a PTX-LCD equipped with TRDSP are compared in the figure below, with special regard to the input card.

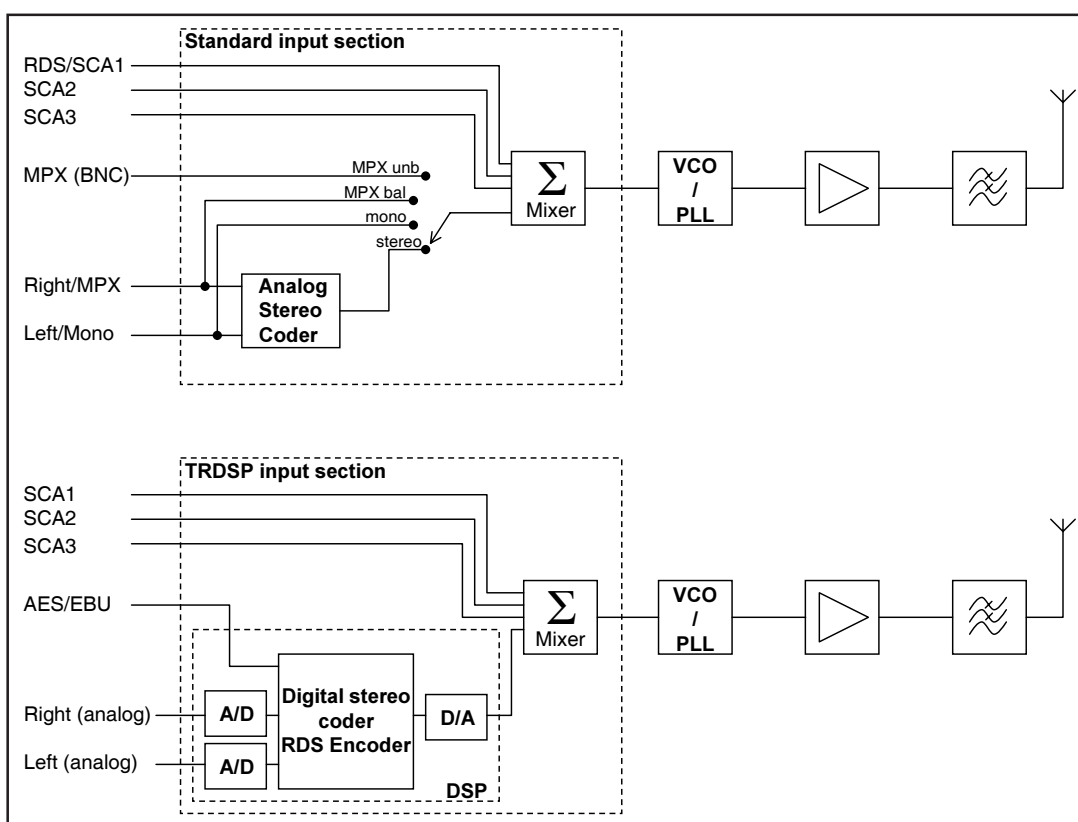

13.12.1 Operating system and TRDSP

When TRDSP is installed, new screens are added to the administration menu to handle the key operating parameters of the card.

13.12.1.1 RF Status

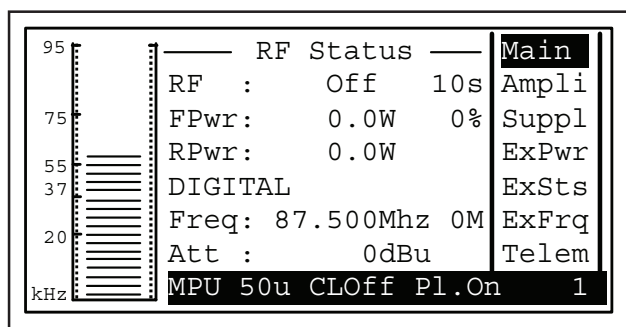

RF RF power output On / Off. Reading and setting of time taken by PTX to reach set power; setting range 1 to 100s

FPwr Output power reading and setting. Reading is expressed in Watts, whereas setting is in percentage of maximum power. If the encoder is pressed when the cursor is on this option, measurement unit label changes from "W" to "%" and the desired percentage can be set by turning the encoder. Press the encoder to store the new setting.

RPwr Reflected power reading in watts.

DIGITAL
Mode of operation of TRDSP card.

0% Output power setting in percent.

Freq Operating frequency. Press the encoder when this parameter is highlighted and then turn the encoder to change frequency value. When the encoder is pressed to store the new frequency setting, the software will prompt for a confirmation ("Are you sure?"). Highlight "Yes" and press the encoder to confirm the new frequency setting or select "No" to abandon change. Value "0M" near the MHz indication identifies the current frequency selection (set from menu "ExFrq") in the event the frequency switching feature is on (switching occurs based on the voltages present at connector DB15).

Att Gain set at audio inputs.

13.12.1.2 Stereo Set

Configuration menu for stereo coder card (where relevant option is installed).

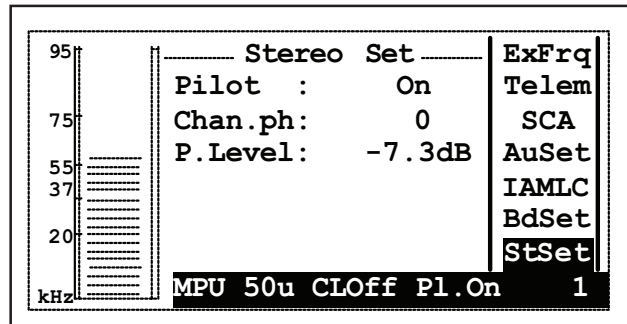

- Pilot Add/remove pilot tone (convenient for some types of measurements).
- Chan.ph Right channel phase, may be 0 or 180 (signal reversal, convenient when measuring "Sub to Main")
- P.Level Pilot tone phase adjustment from -32.8dB to -7.3 dB (only available if PTX-LCD has the optional TRDSP card installed)

13.12.1.3 TrDsp

Optional TrDsp card setup menu.

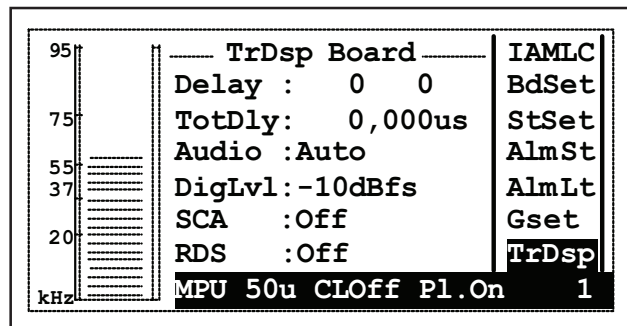

- Delay Signal time delay setting, when used for isofrequency applications with poor step adjustment. The setting range for the first parameter is from 0 to 1900 steps of 5,25 μ s each. The second parameter range is from 0 to 127 steps of 0,05 μ s. The maximum time delay that can be set is 5.47 milliseconds. The actual time delay set is shown under item "Totdly"; it is expressed in microseconds up to a maximum value of 9981,35 μ s.

If **PTX-LCD** is interfaced with a GSM modem, parameter DELAY can be set via SMS.

Two SMS commands are available: DELAY and STEP. DELAY is used to set delay in microseconds. For example, message "DELAY 624" would set delay to 624 μ s (with some minor approximation). STEP is used to make corrections in steps of 0.05 μ s each (+ or -). For example, message "STEP +10" adds 0.5 μ s to the time delay set previously, giving 624.5 μ s. The **PTX-LCD** sends back an SMS message that contains total time delay set, for example "Total Delay Set: 624.5 μ s".

TELECON adds two items to the "General" window: "Delay 1" and "Delay 2 ". They can be adjusted in steps; meaning is as outlined above.

Audio	Input channel mode selection; possible options are digital, analogue or automatic mode.
DigLvl	Digital audio input level setting. It can be adjusted in 1 dBm steps from 0 to -10 dBfs.
SCA	Software switch to enable or disable the SCA inputs of the RDS coder.
RDS	Software switch to enable or disable the RDS coder.

13.12.1.4 I.T.U.

I.T.U. and A.G.C. (Automatic Gain Control) feature setup menu.

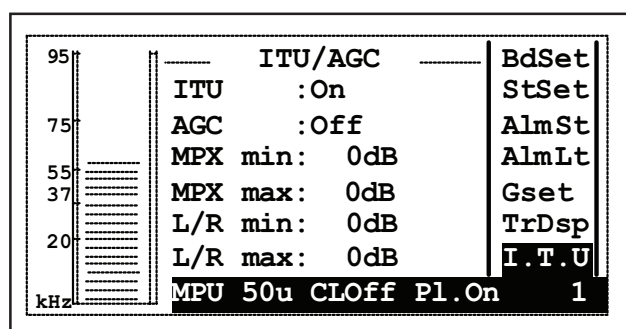

ITU	Enables automatic reduction of signal modulation energy according to standard I.T.U. 412. This feature is always given priority over the A.G.C. feature.
AGC	Mean operation time for Automatic Gain Control. Available options are "OFF", "SLOW", "MIDDLE" and "FAST" mode.
MPX min	Minimum audio level operation threshold in the MPX mode; A.G.C. kicks in when threshold is exceeded; range is 0 to -4 dB.

MPX max

Maximum audio level operation threshold in the MPX mode; A.G.C. kicks in when threshold is exceeded; range is 0 to +4 dB.

L/R min

Minimum audio level operation threshold in the Mono/Stereo mode; A.G.C. kicks in when threshold is exceeded; range is 0 to -12 dB.

L/R max

Maximum audio level operation threshold in the Mono/Stereo mode; A.G.C. kicks in when threshold is exceeded; range is 0 to +12 dB.

13.12.1.5 Isofreq

Setup menu for PTX-LCD isofrequency mode operating parameters.

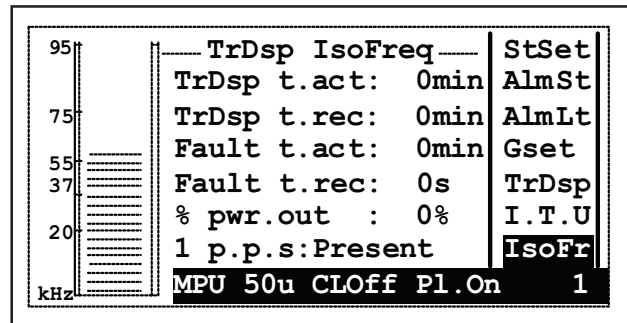

TrDsp t.act

Hysteresis setting for automatic power reduction activation, adjustable from 0 to 120minutes. After the set time has elapsed, power is reduced by the specified percent. The timer starts counting the sync loss reported by the TRDSP card; this feature activates when sync loss duration exceeds set time.

TrDsp t.rec

Power restore hysteresis time setting, can be adjusted from 0 to 120 minutes. Principle of operation is as described above; when back in sync, PTX LCD goes back to delivering the same output power as before reduction .

Fault t.act

Hysteresis setting for automatic power reduction activation, can be adjusted from 0 to 6 hours in 6 min. steps. After the set time, power is reduced by the specified percent. The timer starts counting the sync loss caused by an external "FAULT" indication (e.g.: problems with GPS antenna, etc.), which must persist longer than set time in order for the related feature to activate. Fault signal is provided by PIN4 of the telemetry DB15 connector (see sect. 6.6.1).

Fault t.rec

Power restore hysteresis time setting, can be adjusted from 0 to 6 hours. Principle of operation is as described above; when back in sync, the **PTX-LCD** goes back to delivering the same output power as before reduction .

% pwr.out Power reduction percent of power set in menu "RF Status" under item FPwr. For example, if % pwr.out is set to 50%, and item FPwr in "RF Status" menu is set to 30% of power output, resulting output is 15%.

These parameters can also be set using the "Telecon" software. If power reduction occurs when "low FWD Power" alarm is active, an SMS message that reads "ALARM: low FWD power - Out of Sync" is transmitted.

13.12.1.6 FSK

The **PTX-LCD** operating parameter setup menu for FSK signalling, in which a Morse-coded 6-character alphanumeric code is sent at regular intervals using transmission frequency shift.

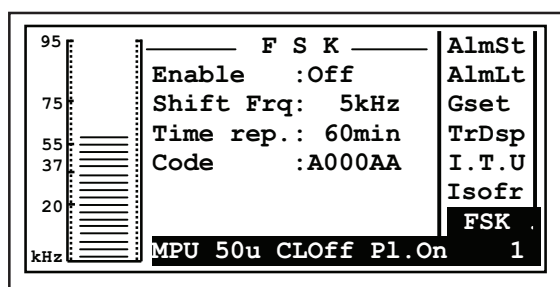

Enable Enables / disable the FSK feature.

Shift Frq Frequency shift with respect to carrier, can be adjusted from 5 to 25 KHz.

Time rep. Repetition time for Morse code transmission, can be adjusted from 0 to 240 minutes.

Code Morse Code sent (composed from a character, three figures and two characters)