

SCM1+1

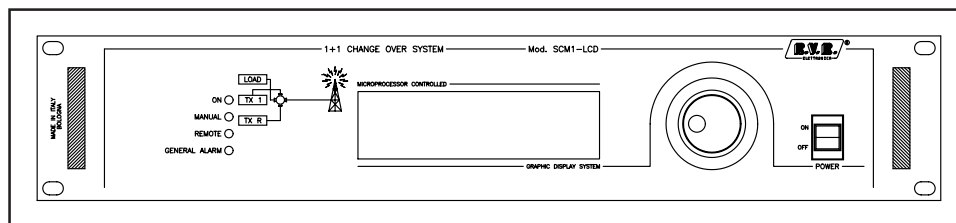

User Manual

LCD Version

Manufactured by  Italy



File name: SCM1+1_EN.p65

Version: 1.0

Date: 02/10/2002

Revision History

Version	Date	Reason	Editor
1.0	02/10/2002	New version	J. Berti

SCM1+1 - User anual
Version 1.0

© Copyright 2002
R.V.R. Elettronica SpA
Via del Fonditore 2/2c - 40138 - Bologna (Italia)
Telefono: +39 051 6010506
Fax: +39 051 6011104
Email: info@rvr.it
Web: www.rvr.it

All rights reserved

Printed and bound in Italy. No part of this manual may be reproduced, memorized or transmitted in any form or by any means, electronic or mechanic, including photocopying, recording or by any information storage and retrieval system, without written permission of the copyright owner.

Table of Content

1. Preliminary Instructions	1
2. Warranty	3
3. First Aid	5
3.1 Treatment of electrical shocks	5
3.2 Treatment of electrical Burns	6
4. General Information	7
4.1 Configuration	8
5. Quick reference	11
5.1 Using the encoder	11
5.2 Quick reference of the SCM1+1 system	12
6. System Status Enquiries	19
6.1 Local enquiries	19
6.2 Remote enquiries with remote control software	19
6.3 Remote enquiries with GSM modem + SMS	19
7. External Features	21
7.1 Description of SCM1+1	21
7.2 Change over card	24
7.3 Additional Standard Telemetry Card	32
7.4 Relay control card	34
7.5 Description of service connectors PIN	38
8. Identification and Access to modules	39
8.1 CPU card	39
8.2 Panel card	39
8.3 Telemetry card	40
8.4 Relay control card	41
8.5 Power supply	41
9. Card settings	43
9.1 Setting of the card internal address	43
9.2 Setting of the Dip-Switches	44
10. Software description	47
10.1 Flow chart	47
10.2 Main - Schermata principale	48
10.3 GSet - General settings	49
10.4 Info - Information about system configuration	50
10.5 Wait - Setting the time	50
10.6 Alarm - Alarm report	51
10.7 INP01, ..., N - Card input values	52
10.8 OUT01, ..., N - Relay output status	52

This page was intentionally left blank

1. Preliminary Instructions

This manual is written as a general guide for those having previous knowledge and experience with this kind of equipment, well conscious of the risks connected with the operation of electrical equipment.

It is not intended to contain a complete statement of all safety rules which should be observed by personnel in using this or other electronic equipment.

The installation, use and maintenance of this piece of equipment involve risks both for the personnel performing them and for the device itself, that shall be used only by trained personnel.

R.V.R. Elettronica SpA doesn't assume responsibility for injury or damage resulting from improper procedures or practices by untrained/unqualified personnel in the handling of this unit.

Please observe all local codes and fire protection standards in the operations of this unit.



WARNING: always disconnect power before opening covers or removing any part of this unit.

Use appropriate grounding procedures to short out capacitors and high voltage points before servicing.



WARNING: this device can irradiate radio frequency waves, and if it's not installed following the instructions contained in the manual and local regulations it could generate interferences in radio communications.

This is a "CLASS A" equipment. In a residential place this equipment can cause hash. In this case can be requested to user to take the necessary measures.

R.V.R. Elettronica SpA reserves the right to modify the design and/or the technical specifications of the product and this manual without notice.

This page was intentionally left blank

2. Warranty

Any product of **R.V.R. Elettronica** is covered by a 24 (twenty-four) month warranty.

For components like tubes for power amplifiers, the original manufacturer's warranty applies.

R.V.R. Elettronica SpA extends to the original end-user purchaser all manufacturers warranties which are transferrable and all claims are to be made directly to R.V.R. per indicated procedures.

Warranty shall not include:

- 1 danni verificatisi durante la spedizione della macchina alla R.V.R. per eventuali riparazioni;
- 2 Any unauthorized repair/modification;
- 3 Incidental/consequential damages as a result of any defect
- 4 Nominal non-incidentual defects
- 5 Re-shipment costs or insurance of the unit or replacement units/parts

Any damage to the goods must be reported to the carrier in writing on the shipment receipt.

Any discrepancy or damage discovered subsequent to delivery, shall be reported to **R.V.R. Elettronica** within **5** (five) days from delivery date.

To claim your rights under this warranty, you should follow this procedure:

- 1 Contact the dealer or distributor where you purchased the unit. Describe the problem and, so that a possible easy solution can be detected.

Dealers and Distributors are supplied with all the information about problems that may occur and usually they can repair the unit quicker than what the manufacturer could do. Very often installing errors are discovered by dealers.

- 2 If your dealer cannot help you, contact **R.V.R. Elettronica** and explain the problem. If it is decided to return the unit to the factory, **R.V.R. Elettronica** will mail you a regular authorization with all the necessary instructions to send back the goods.
- 3 When you receive the authorization, you can return the unit. Pack it carefully for the shipment, preferably using the original packing and seal the package perfectly. The customer always assumes the risks of loss (i.e., R.V.R. is never responsible for damage or loss), until the package reaches R.V.R. premises. For this reason, we suggest you to insure the goods for the whole value. Shipment must be effected C.I.F. (PREPAID) to the address specified by R.V.R.'s service manager on the authorization



DO NOT RETURN UNITS WITHOUT OUR AUTHORIZATION AS THEY WILL BE REFUSED

- 4 Be sure to enclose a written technical report where mention all the problems found and a copy of your original invoice establishing the starting date of the warranty.

Replacement and warranty parts may be ordered from the following address. Be sure to include the equipment model and serial number as well as part description and part number.



R.V.R. Elettronica SpA
Via del Fonditore, 2/2c
40138 BOLOGNA
ITALY
Tel. +39 51 6010506

3. First Aid

The personnel employed in the installation, use and maintenance of the device, shall be familiar with theory and practice of first aid..

3.1 Treatment of electrical shocks

3.1.1 If the victim is not responsive

Follow the A-B-C's of basic life support

- Place victim flat on his back on a hard surface.
- Open airway: lift up neck, push forehead back (Fig. 3-1).
- clear out mouth if necessary and observe for breathing
- if not breathing, begin artificial breathing (Figure 3-2): tilt head, pinch nostrils, make airtight seal, four quick full breaths. Remember mouth to mouth resuscitation must be commenced as soon as possible

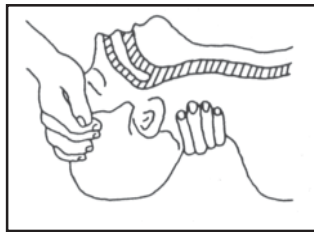

Figure 3-1

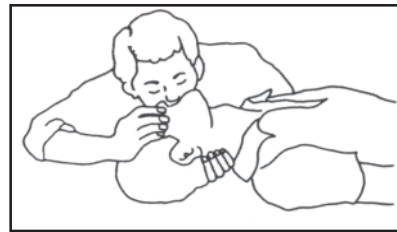

Figure 3-2

- Check carotid pulse (Fig 3-3); if pulse is absent, begin artificial circulation (Fig. 3-4) depressing sternum (Fig. 3-5)

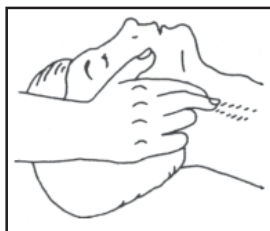

Figure 3-3

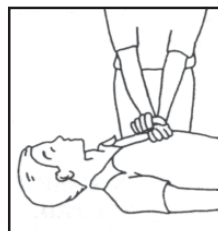

Figure 3-4

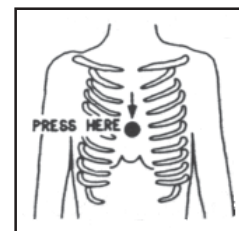

Figure 3-5

- In case of only one rescuer, 15 compressions alternated to two breaths.
- If there are two rescuers, the rythm shall be of one brath each 5 compressions.
- Do not interrupt the rythm of compressions when the second person is giving breath.
- Call for medical assistance as soon as possible.

3.1.2 If victim is responsive

- Keep them warm
- Keep them as quiet as possible
- Loosen their clothing (a reclining position is recommended)
- Call for medical help as soon as possible

3.2 Treatment of electrical Burns

3.2.1 Extensive burned and broken skin

- Cover area with clean sheet or cloth
- Do not break blisters, remove tissue, remove adhered particles of clothing, or apply any salve or ointment.
- Treat victim for shock as required.
- Arrange transportation to a hospital as quickly as possible.
- If arms or legs are affected keep them elevated

If medical help will not be available within an hour and the victim is conscious and not vomiting, give him a weak solution of salt and soda: 1 level teaspoonful of salt and 1/2 level teaspoonful of baking soda to each quart of water (neither hot or cold). Allow victim to sip slowly about 4 ounces (half a glass) over a period of 15 minutes. Discontinue fluid if vomiting occurs



DO NOT give alcohol

3.2.2 Less severe burns

- Apply cool (not ice cold) compresses using the cleansed available cloth article.
- Do not break blisters, remove tissue, remove adhered particles of clothing, or apply salve or ointment.
- Apply clean dry dressing if necessary.
- Treat victim for shock as required.
- Arrange transportation to a hospital as quickly as possible
- If arms or legs are affected keep them elevated.

4. General Information

The devices of which the SCM-TLC system consists are all made in 19" 2U rack containers, with the exception of the TLC300, which is 19" 1U size.

Entirely assembled with modules fitted on the base of the device and connected with snap-in fitting connectors, they are easily removed, substituted and added.

On the front panel is a clear graphical user interface which allows you to read and set the operating parameters; the entire system can be controlled using a simple knob (encoder).

On the front panel there is also a set of LEDs, again depending on the preset configuration, which show system status at a glance.

On the rear panel are all of the connectors to be used for connecting the device to the various station components.

The SCM-TLC automatic change over and telemetry system and relative management software were designed to solve all of those problems arising from the management of radio stations located in areas that are not easily reached or which would require a significant amount of time for the operator to reach.

The system has the following main functions:

- management of several radio stations by remote connection with a data-phone modem;
- telemetrization of all operating parameters of the devices present in each station;
- storage in the memory of events which caused faults;
- automatic change over in "1+1" or "N+1" radio transmission systems.

This system allows remote management of the radio station, allowing the operator to intervene immediately in the event of a fault.

The great flexibility of the SCM-TLC system allows an increase in the number of devices controlled or modification of the station layout at any time, without necessitating radical changes in the management system, but simply adding expansion cards which allow an increase in the number of operating parameters that can be managed.

The SCM-TLC system was designed to operate at its best with all R.V.R. devices, but can also function with devices not made by R.V.R., provided that they make the main operating parameters available externally by means of analog signals with values between 0 and +5V.

The management software has a user friendly interface and can be managed using any personal computer with the WINDOWS™ environment.

4.1 Configuration

The SCM-TLC system has two main types of operation, within which there may be various versions, depending on the number of data acquisition cards fitted: automatic change over (1+1 or N+1) and telemetry, or just telemetry.

4.1.1 Automatic change over and telemetry

Two types of devices control this type of operation:

- SCM 1+1-LCD: automatic change over between the main transmitter and a stand-by transmitter; supports up to 3 additional telemetry cards for a total of 30 balanced analog inputs, 58 digital/analog inputs and 24 relay outputs.
- SCM 4+1-LCD: automatic change over among several main transmitters (up to 4) and a stand-by transmitter, automatically configured to substitute the transmitter affected by the fault (the stand-by must have an external control for setting the operating frequency); supports up to 2 additional telemetry cards, for a total of 27 balanced analog inputs, 52 unbalanced digital/analog inputs and 16 relay outputs.

4.1.2 Telemetry

Two devices are available for station telemetry, depending on complexity and the number of parameters to be acquired:

- TLC300: includes 2 telemetry cards, for a total of 16 balanced analog inputs, 32 digital/analog inputs and 16 relay outputs.
- TLC2000: supports up to 6 additional telemetry cards, for a total of 48 balanced analog inputs, 96 unbalanced digital/analog inputs and 48 relay outputs.

The table below summarizes all possible SCM-TLC system configurations.

Device	Type	Version	bal. IN	dig./an. IN	OUT rly
SCM1-LCD	SCM 1+1 & TLM	T0	6	10	0
SCM1-LCD	SCM 1+1 & TLM	T1	14	26	8
SCM1-LCD	SCM 1+1 & TLM	T2	22	42	16
SCM1-LCD	SCM 1+1 & TLM	T3	30	58	24
SCM4/1-LCD	SCM N+1 & TLM	T0	11	20	0
SCM4/1-LCD	SCM N+1 & TLM	T1	19	36	8
SCM4/1-LCD	SCM N+1 & TLM	T2	27	52	16
TLC300	TLM	T1	8	16	8
TLC300	TLM	T2	16	32	16
TLC2000	TLM	T0 (*)	0	0	0
TLC2000	TLM	T1	8	16	8
TLC2000	TLM	T2	16	32	16
TLC2000	TLM	T3	24	48	24
TLC2000	TLM	T4	32	64	32
TLC2000	TLM	T5	40	80	40
TLC2000	TLM	T6	48	96	48

(*) External communications management only.



The version's name depends on the number of additional telemetry cards and is indicated by the number after the "T" (e.g.: T0 indicates that there are no telemetry cards, T1 indicates that one additional telemetry card is fitted and so on).

SCM1+1 \T0

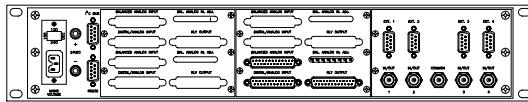

SCM1+1 \T1

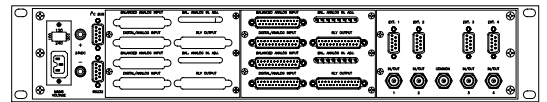

SCM1+1 \T2

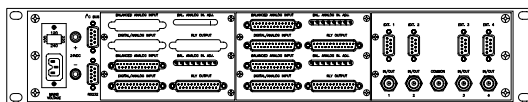

SCM1+1 \T3

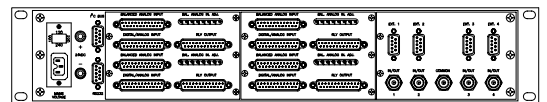

SCM4+1 \T0

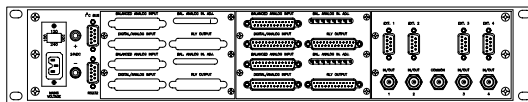

SCM4+1 \T1

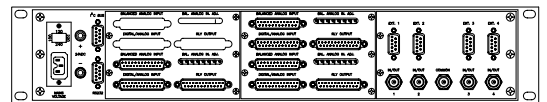

SCM4+1 \T2

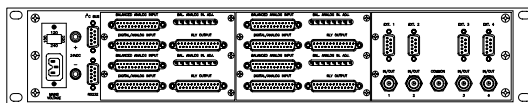

TLC2000 \T0

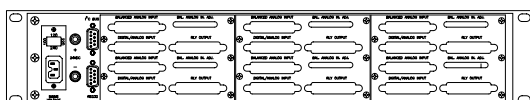

TLC2000 \T1

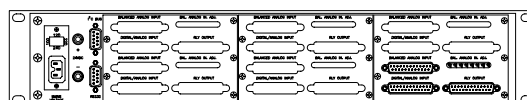

TLC2000 \T2

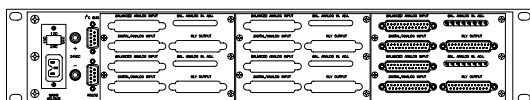

TLC2000 \T3

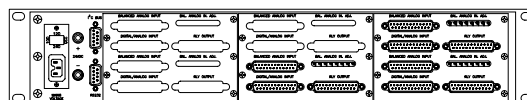

TLC2000 \T4

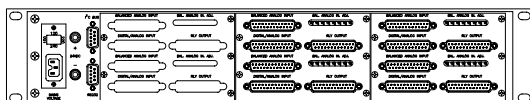

TLC2000 \T5

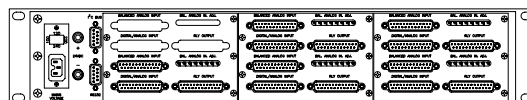

TLC2000 \T6

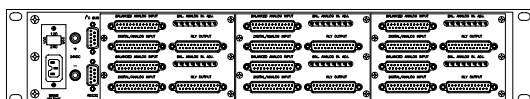

TLC300 \T0



TLC300 \T1



TLC300 \T2

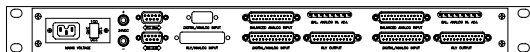

5. Quick reference

The purpose of this chapter is to summarize the points that should be adhered to for using the machines. Should any point not be fully comprehensible, such as how to operate the machine the first time, the description of the operating system should be read very carefully.

5.1 Using the encoder

The interaction between the user and the control software of the device takes place by means of the encoder.

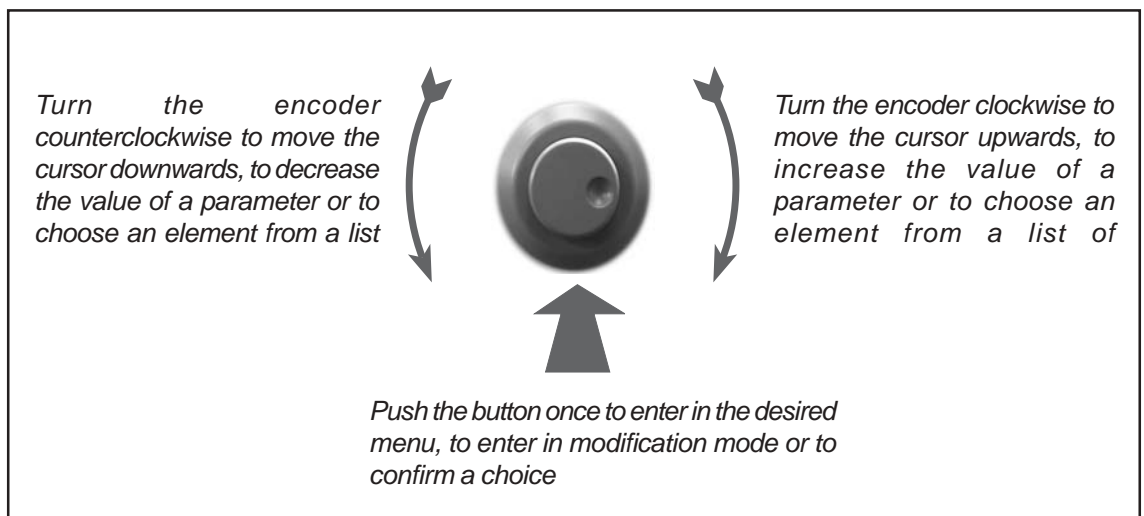

The following operations are performed on the encoder:

- **turning:** to move the cursor up or down on the display; turn the encoder to the left to move the cursor down, to the right to move the cursor up. Also used for increasing or decreasing the selected parameters (to the left to decrease the value, to the right to increase it) and for selecting an item from a list of options
- **pressing:** press the button once when the cursor is pointing to the name of a menu to access that menu, press the button when the cursor is pointing to a parameter to access the change mode (the cursor begins to blink). After having changed a parameter, press the button to store the new value.

After having changed a parameter, the cursor keeps blinking for about thirty seconds waiting for confirmation. If the user does not confirm the change, the machine emits a sound to warn the user that the change was not confirmed. As such, the cursor stops blinking and points to the selected parameter.

5.2 Quick reference of the SCM1+1 system

5.2.1 Manual change over

To set the manual change over mode, select the "RETRY" number in the main screen page and set it to zero. If the icon ☒ does not appear, select ○ and press the encoder.

This type of operation inhibits controls of the power and, if necessary, of the TX audio input: change over between the two TXs can only be provoked remotely with the remote control software, or locally by pressing the encoder when the arrow-shaped cursor indicates the coaxial relay in the main screen page.

The individual transmitters may be switched on and off, when not using the change over function, by pressing the encoder when the arrow-shaped cursor indicates the required transmitter.

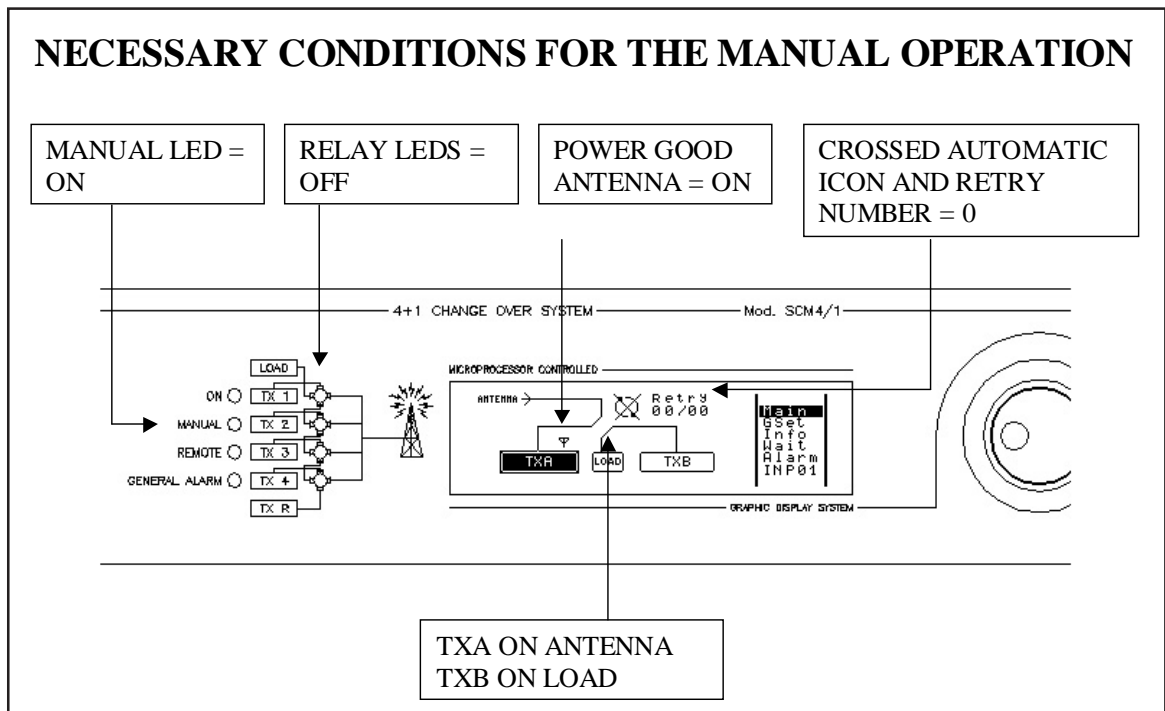

5.2.2 Automatic change over

To set the automatic change over mode, select the required "RETRY" number in the main screen page, select the icon at the top right-hand corner of the menu and press the encoder.

This type of operation enables controls of the power and, if necessary, of the TX audio input: the stand-by transmitter is activated automatically in lieu of the main transmitter when power is insufficient at TX output. Even in this case change over between the two TXs can be provoked remotely with the remote control software, or locally by pressing the encoder when the arrow-shaped cursor indicates the coaxial relay in the main screen page.

The individual transmitters may be switched on and off, when not using the change over function, by pressing the encoder when the arrow-shaped cursor indicates the required transmitter.

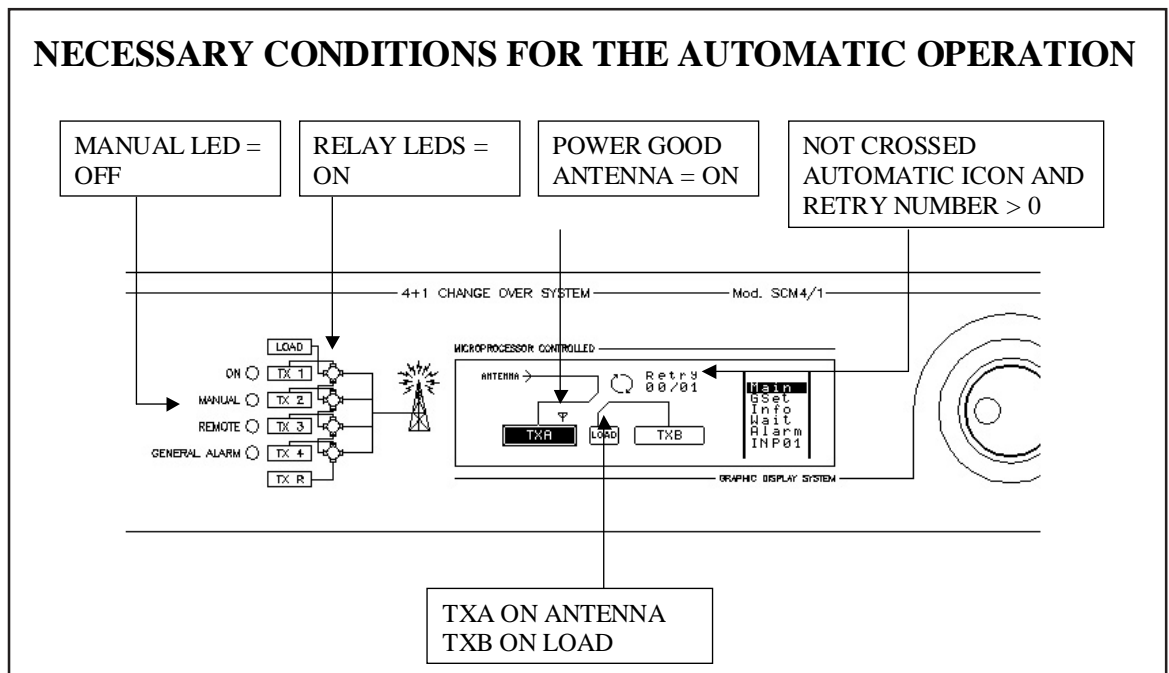

The wait time for every single change over is managed by and set in the "WAIT" menu.

Time Set		
Start SCM	: 05:00	Main
Before Switch	: 00:05	GSet
Wait Tx Off	: 02:00	Info
Wait Coax Ack	: 02:00	Wait
After Switch	: 03:00	Alarm
Audio Alarm	: 00:00	INP01

5.2.3 Alarm conditions

The different possible conditions indicated by the SCM are described in another section.

5.2.3.1 Transmitter fault

This occurs when the level of power supplied by TX drops below the analog Power Good level set and the digital Power Good input simultaneously goes to a high logic level, i.e.: when both of the Power Good inputs generate an alarm. This is the reason why only one of the two must be used: analog, inserting the pull-up at the digital input, or digital, leaving the analog input open.

Procedure for the management of a TX fault:

- switch off TX;
- check that TX is switched off;
- switch the coaxial relay;
- check that the coaxial relay has switched;
- switch on TXB.

The exclamation mark, which indicates TX fault, is displayed until the alarms are reset.



Both transmitters weigh the same and the change over is managed in both directions as many times as indicated in the "RETRY" number.

5.2.3.2 Audio signal missing (PTX-LCD only)

The audio signal presence control is carried out only if the exciter of the transmitters is a PTX-LCD series exciter; controls of this type, and relative management, are carried out only on the active exciters.

Management procedure for a missing audio signal on the transmitter:

- switch off TX;
- check that TX is switched off;
- switch the relative coaxial relay;
- check that the coaxial relay has switched;
- switch on TXB.

The exclamation mark, which indicates automatic transmitter change over, is displayed until the alarms are reset.

5.2.3.3 Dummy load fault

This situation is linked to overheating of the dummy load or absence of load ventilation,

detected by special sensors.

The SCM indicates this fault locally and remotely.

5.2.3.4 Coaxial relay fault

If the position signals from the coaxial relay are not coherent with the commands issued to it, the SCM considers the coaxial relay faulty, sets itself to manual mode and indicates this condition locally and remotely.

5.2.3.5 No mains power

If the SCM has battery backup, it can cope with an interruption of the mains power supply.

System status is frozen during the mains power cut.

When mains power is restored, the SCM waits until the power-up wait time set in the "WAIT" menu has elapsed and then takes into consideration any alarm conditions.

Therefore, set the power-up wait time to approx. 3 minutes, so that the various devices of which the system is composed have time to return to their normal operating states when mains power is restored, and the SCM does not provoke an unwanted change over.

5.2.3.6 Alarm default codes

CODE	Indication	Meant
001	Trasmitter Fault	Transmitter damage
002	Load Fault	Dummy load damage
003	Sw.Coax Fault	Coaxial relay damage
004	RESERVED	RESERVED
005	No Audio	Absence of audio signal
006	Low Power	Low power (-3dB) amplifier (*)
007	Fault Mains Power	Absence of mains power
008	Fault Mod I2C	I2C module damage
009	Restart	System restart
010	Interlock	Automatic change over Inhibition
≥ 011		General alarms adjustable from user

(*): Only for systems with dual exciter.

5.2.4 Alarm indications

The SCM indicates faults locally and remotely, by sending a series of messages according to methods which depend on the SCM configuration.

As is the case for alarm management, the SCM waits until the alarm management time set has elapsed before issuing indications.

5.2.4.1 Local indication

- The GENERALALARM LED on the front panel lights up;
- a line is added to the "Alarm" menu, indicating the time, date and code of the alarm.

5.2.4.2 Remote indication by data-phone modem

- The SCM calls all of the set telephone numbers in sequence and communicates the code, the TX in question and the alarm description (at the other end of the line a PC with the "Hyper Terminal" software, supplied with all Windows™ environments, must be connected in stand-by);
- the SCM repeats the series of calls, the number of times indicated in the remote programming, via remote control software.

5.2.4.3 Remote indication by pager

- The SCM calls all of the set pager numbers in sequence, communicating the relative alphanumeric code;
- it calls all of the set telephone numbers in sequence and communicates the code, the TX in question and the alarm description (at the other end of the line a PC with the "Hyper Terminal" software, supplied with all Microsoft Windows operating systems, must be connected in stand-by);
- the SCM repeats the series of calls, the number of times indicated in the remote programming, via remote control software.

5.2.4.4 Remote indication by GSM modem

- The SCM calls all of the set pager or modem numbers in sequence, communicating the relative alphanumeric code;
- it calls all of the telephone numbers indicated in the remote control software programming and communicates the code, the TX in question and the alarm description by means of SMS text messages.

CONDIZIONI NECESSARIE PER L'INVIO DEI MESSAGGI SMS

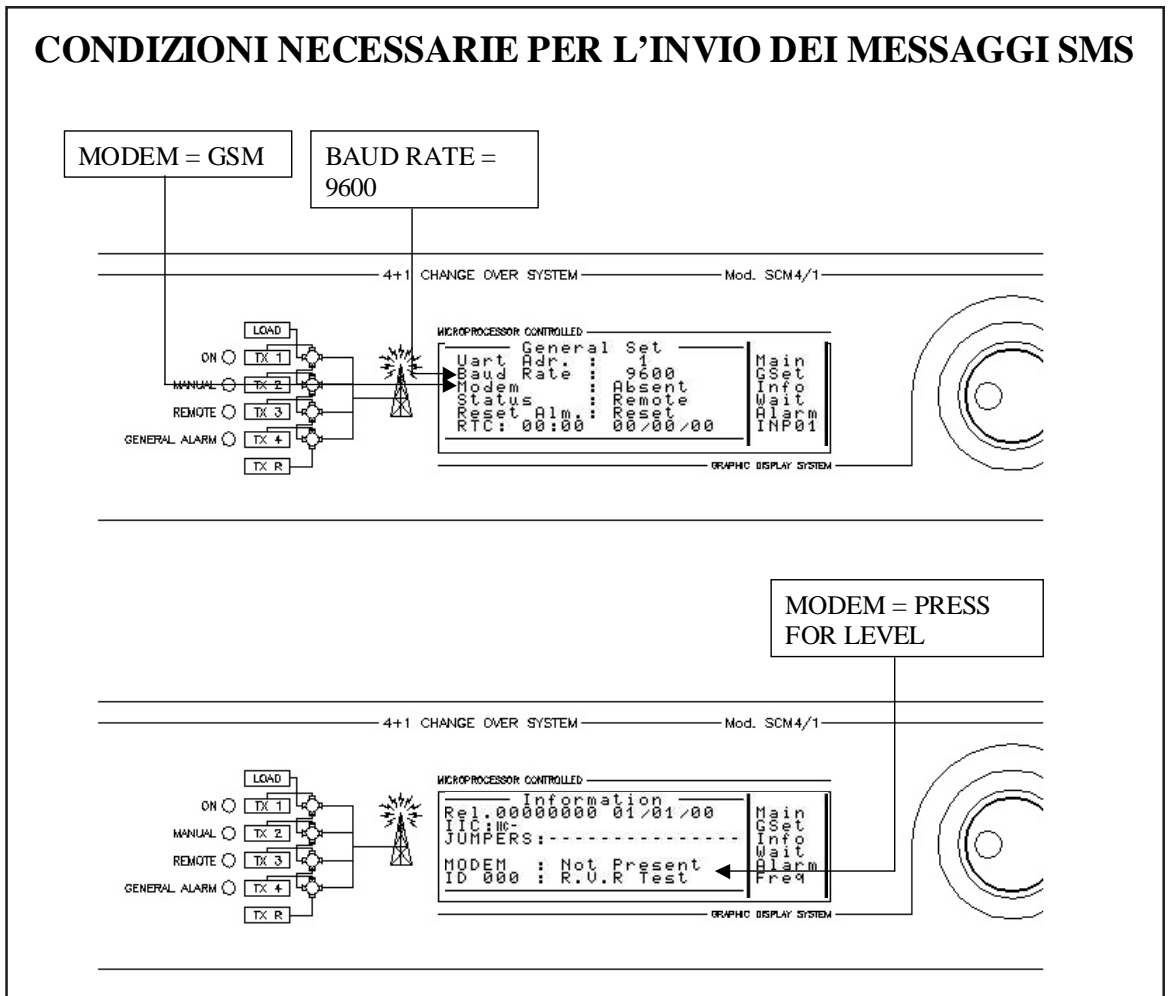

Keep in mind that to send SMS messages, the device must be programmed by the specific TELECON program in order to enter the number of the Service Center, which is essential for sending messages correctly.

This page was intentionally left blank

6. System Status Enquiries

6.1 Local enquiries

The SCM and TLC2000 devices indicate their status locally and concisely by means of the indicator lights on the front panel. More detailed information can be obtained from the setting and configuration menus.

6.2 Remote enquiries with remote control software

A PC with the Telecon telemetry and remote control software can be used to obtain a very detailed view of all system operating parameters and of all the settings both of the equipment and the devices connected to said equipment.

6.3 Remote enquiries with GSM modem + SMS

Any GSM mobile telephone can be used to query the devices with this system. The device will respond as outlined in the tables in the sections below.

Before querying the system by means of SMS messages, you must be connected by means of the "TELECON" program and set the number of the selected phone Service Center as well as the telephone numbers that can send this type of command to the devices.

6.3.1 List of SMS messages that can be sent to SCM1+1 devices

Send:	Answer:
INFO	Station Name: TXA Antenna / TXB Antenna / Coax Fault TXA ON / OFF TXB ON / OFF Automatic / Manual Retry:0/0 Load FAULT / OK Mains FAULT / OK Alarm: (lista allarmi presenti)
TXONn	Station Name: TX ON / se n > 2 o n < 1 Not Exist
TXOFFn	Station Name: TX OFF / se n > 2 o n < 1 Not Exist
TXSWNn	Station Name: TXA On Antenna
TXSWRn	Station Name: TXB On Antenna
RESETMOD	
RESET	Station Name: ALL RESET

This page was intentionally left blank

7. External Features

This chapter describes the components located on the front and rear panels of the SCM-TLC systems.

7.1 Description of SCM1+1

7.1.1 Front panel

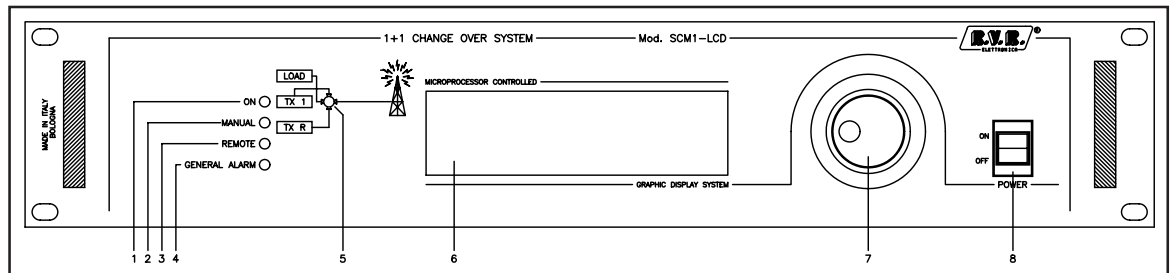

- | | |
|-------------------|---|
| [1] ON | Indicates that the device is switched on |
| [2] MANUAL | Indicates that the manual change over mode is set |
| [3] REMOTE | Fixed on, indicates that remote control is set; flashing, indicates that a connection via the RS232 serial port is in progress |
| [4] GENERAL ALARM | Indicates that an alarm occurred in the system |
| [5] TX | Indicates, if on, that the corresponding TX was changed over with the stand-by, i.e.: that the relative coaxial relay has switched and is in position 2 |
| [6] DISPLAY | Graphically managed LCD (240x64 pixels) and text (30x8 characters) |
| [7] ENCODER | Ball grip and button for software control |
| [8] POWER | Mains switch |

7.1.2 Rear panel

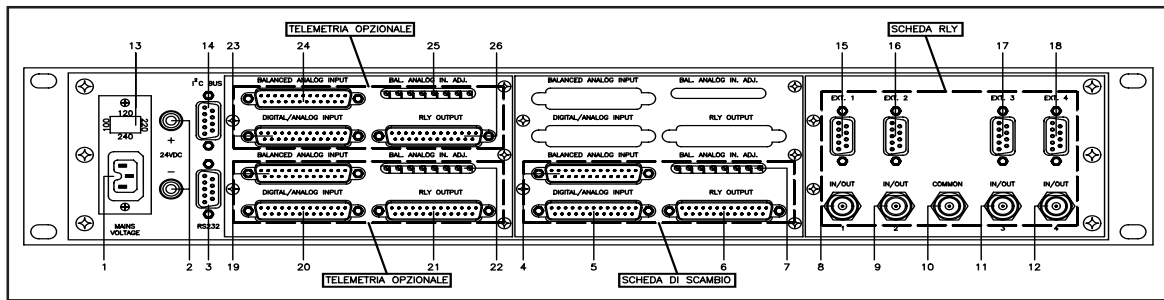

- | | |
|---------------------------------------|---|
| [1] MAINS VOLTAGE | Mains connector |
| [2] 24VDC | Socket for 24Vdc external power supply |
| [3] RS-232C | DB9 connector for direct communications or via serial modem |
| [4] BALANCED ANALOG INPUT 1 | DB25 input connector - each one is to connect eight balanced analog signals, provided that voltage is between 2 and 12V |
| [5] DIGITAL/ANALOG INPUT 1 | DB25 input connector - to connect sixteen unbalanced signals: in the case of digital inputs, configure as low active, in the case of analog inputs, the limit voltage is 5V |
| [6] RLY OUTPUT 1 | DB25 output connector - makes the outputs of eight bistable relay switches available |
| [7] BAL.ANALOG IN. ADJ. 1 | Trimmer for adjusting voltage at input of the machine's internal circuitry voltage |
| [8] IN/OUT 1 | TX1 audio input |
| [9] IN/OUT 2 | TX2 audio input, not used |
| [10] COMMON | TXR audio input |
| [11] IN/OUT 3 | TX3 audio input, not used |
| [12] IN/OUT 4 | TX4 audio input, not used |
| [13] VOLTAGE CHANGER & A.C. LINE FUSE | Fuse and voltage changer block. Use a small screwdriver to change the fuse or the mains voltage. Turn the block and position it at the arrow for the required voltage. |
| [14] I2C BUS | DB9 connector - for communications in I2C standard |
| [15] EXT. 1 | DB9 output connector - for signals which control coaxial relay switching |
| [16] EXT. 2 | DB9 output connector - for signals which control coaxial relay switching, not used |
| [17] EXT. 3 | DB9 output connector - for signals which control coaxial relay switching, not used |
| [18] EXT. 4 | DB9 output connector - for signals which control coaxial relay switching, not used |
| [19] BALANCED ANALOG INPUT 2 | DB25 input connector - each one is to connect eight balanced analog signals, provided that voltage is between 2 and 12V |
| [20] DIGITAL/ANALOG INPUT 2 | DB25 input connector - to connect sixteen unbalanced signals: in the case of digital inputs, configure as low active, in the case of analog inputs, the limit voltage is 5V |
| [21] RLY OUTPUT 2 | DB25 output connector - makes the outputs of eight bistable relay switches available |
| [22] BAL.ANALOG IN. ADJ. 2 | Trimmer for adjusting voltage at input of the machine's internal circuitry voltage |
| [23] DIGITAL/ANALOG INPUT 3 | DB25 input connector - to connect sixteen unbalanced signals: in the case of digital inputs, configure as low active, in the case of analog inputs, the limit voltage is 5V |

- [24] BALANCED ANALOG INPUT 3 DB25 input connector - each one is to connect eight balanced analog signals, provided that voltage is between 2 and 12V
- [25] BAL.ANALOG IN. ADJ. 3 Trimmer for adjusting voltage at input of the machine's internal circuitry voltage
- [26] RLY OUTPUT 3 DB25 output connector - makes the outputs of eight bistable relay switches available



NOTE: The figure shows the rear panel of an SCM1+1, T2 version.



NOTE: The DB25 connectors (4-6) and the trimmers (7) belong to standard telemetry card n.1, which is always present, whatever the SCM1+1 configuration. This card manages the commands, the telemetry operations and standard alarms.

If the parameters to be controlled must be increased, one or two additional telemetry cards are added (19-22 and 23-26).

7.2 Change over card

These are normal telemetry cards but are used by the managing firmware for controlling the parameters of the change over card which affect machine operations.

Acquires telemetry data in two ways:

- Balanced analog with a limit voltage which can be adjusted between 2V and 12V using a trimmer (eight inputs);
- Unbalanced analog with a limit voltage fixed at 5V, or digital with 2.2 KOhm internal pull-up which can be switched on using a jumper (sixteen inputs).

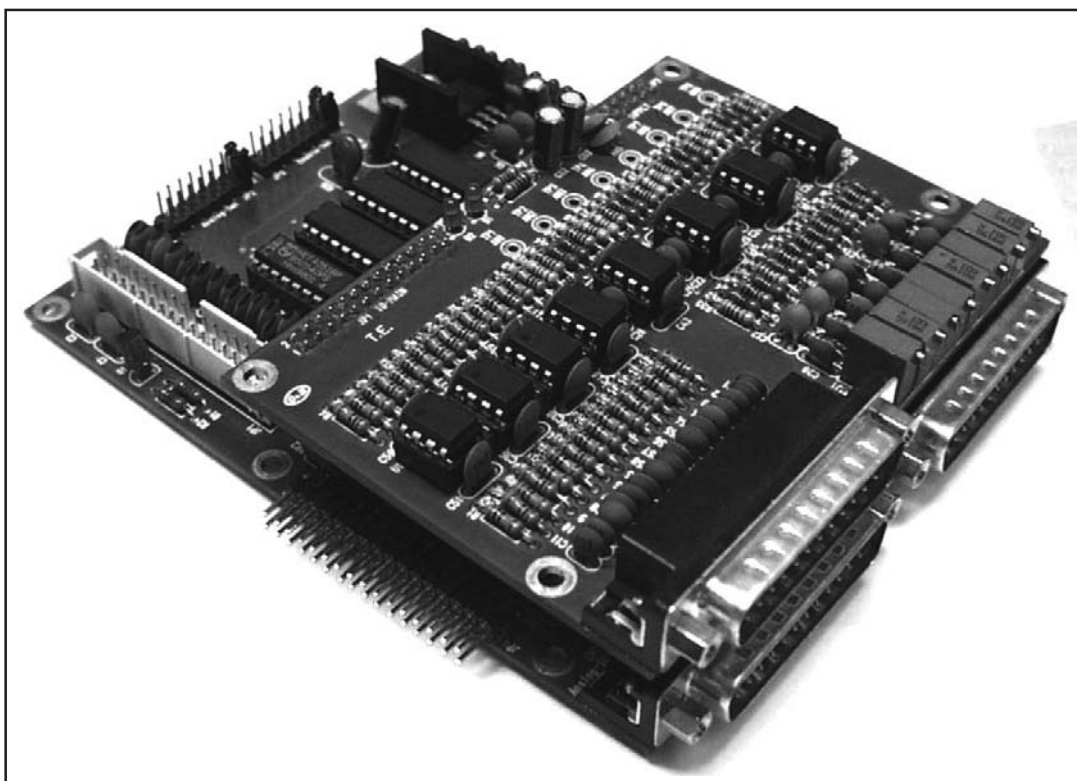

The telemetry card also makes the contacts of eight relay switches available in output (max. 24V - 0.5A).

7.2.1 Balanced Analog Input

Each of these connectors can be used to connect eight balanced analog signals to the device, as indicated in the table; each input accepts a voltage between 2 and 12V.

The table summarizes the functions to which a few balanced analog inputs of this card are dedicated.

Input No. 1 is used for setting, with the relative trimmer, the level of power supplied by TXA. On dropping below this level the transmitter is considered faulty; likewise, input No. 2 performs the same function for TXB.

Pin number	Meant	Adj. Trimmer
2 (+), 14 (-)	Power Good level of TXA	RV1
3 (+), 16 (-)	Power Good level of TXB	RV2
5 (+), 17 (-)	Available	RV3
6 (+), 19 (-)	Available	RV4
8 (+), 20 (-)	Available	RV5
9 (+), 22 (-)	Available	RV6
11 (+), 23 (-)	Available	RV7
12 (+), 25 (-)	Available	RV8
1, 4, 7, 10, 13, 15, 18, 21, 24	GND	

Limit voltages ranging from a minimum of 2V to a maximum of 12V can be applied to the balanced inputs. However, during data processing, the CPU works with a theoretical limit value of 5V. For this reason, there are eight trimmers (RV1-RV8), next to the connector, one for each input, which are used to adjust the limit value set externally to that of the internal circuitry.

To prevent the non-linearity introduced by protective diodes, do not exceed the 4V limit.

The foregoing table shows each balanced input with the relative adjustment trimmer.

7.2.1.1 Adjusting the Power Good levels

To adjust the TX minimum power level, below which it is considered faulty:

- on the SCM open the main screen page;
- set the TX in question so that it supplies the minimum acceptable power: the antenna symbol appears above the TX;
- adjust the relative trimmer until the antenna symbol above the TX in question disappears.

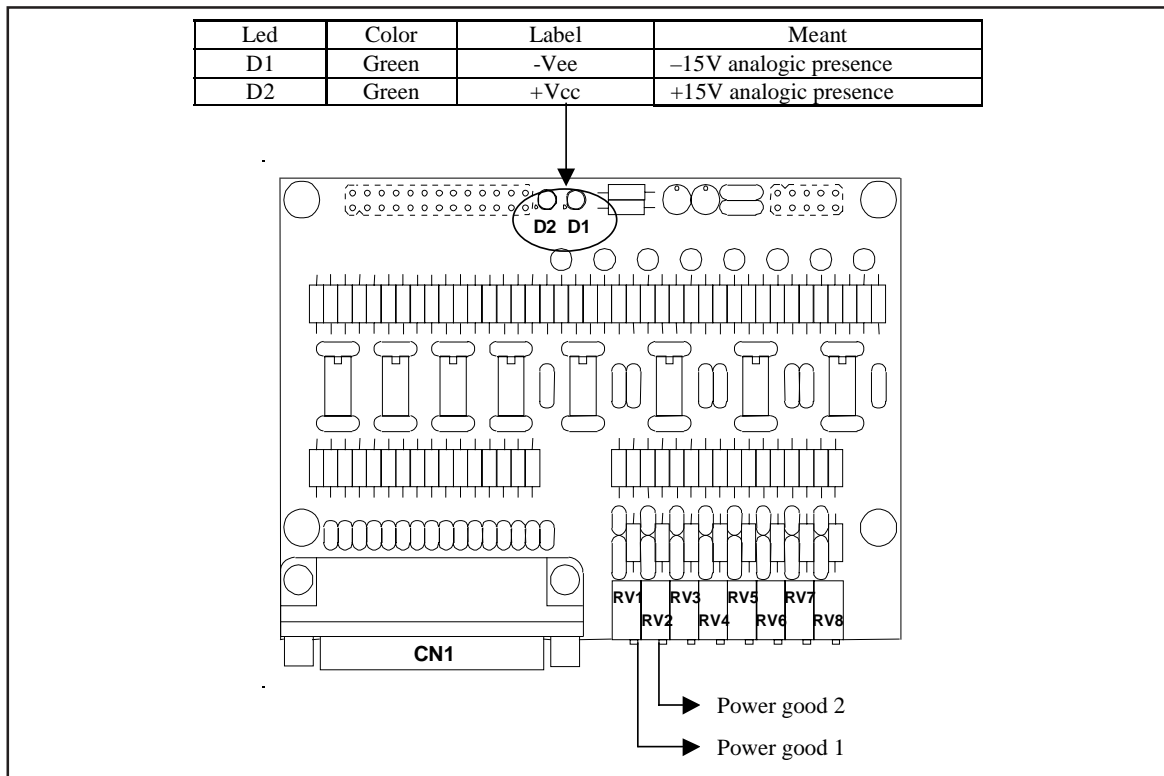

7.2.2 Digital/Analog Input

This connector can be used to connect sixteen unbalanced inputs to the device. The type of input (analog or digital) depends on the system controlled, the program stored in the Eprom and loaded by the CPU at power up.

In the case of analog inputs, the limit voltage is 5V; this too should be limited to 4V due to the non-linearity of the protective diodes.

The table summarizes the functions to which some of the unbalanced analog/digital inputs on this card are dedicated.

Inputs No. 1 and No. 2 are the digital Power Good inputs of TXA and TXB and are connected in AND to the respective analog Power Good inputs. A low logic level means that the TX is operating normally.



NOTA: If using a system with a dual exciter, a high logic level at input No. 3 indicates an amplifier fault.

A low logic level on input No. 6 indicates a fault in the dummy load.

Input No. 7 indicates that there is no mains power, obviously, provided that the SCM system has battery backup.

A low logic level at input No. 8 sets the machine in stand-by, inhibiting the automatic change over operations.

Inputs No. 9 and No. 13 can be used to provoke manual change over of the TXA or TXB on the dummy load. This occurs when the input is brought to the low logic level for at least half a second.

Led	Color	Label	Meant
D28	Red	RLY1	Relay coax n°1 Off
D29	Red	RLY2	Relay coax n°2 Off
D33	Red	RLY3	Relay coax n°3 Off
D34	Red	RLY4	Relay coax n°4 Off
D30	Red	RLY5	Relay coax n°5 Off
D32	Red	RLY6	Relay coax n°6 Off
D35	Red	RLY7	Relay coax n°7 Off
D31	Red	RLY8	Relay coax n°8 Off
D36	Green	+5V	+5V digital presence
D2	Green	-Vee	-15V digital presence
D3	Green	+Vcc	+15V digital presence
D1	Red	TEST	Data passage check

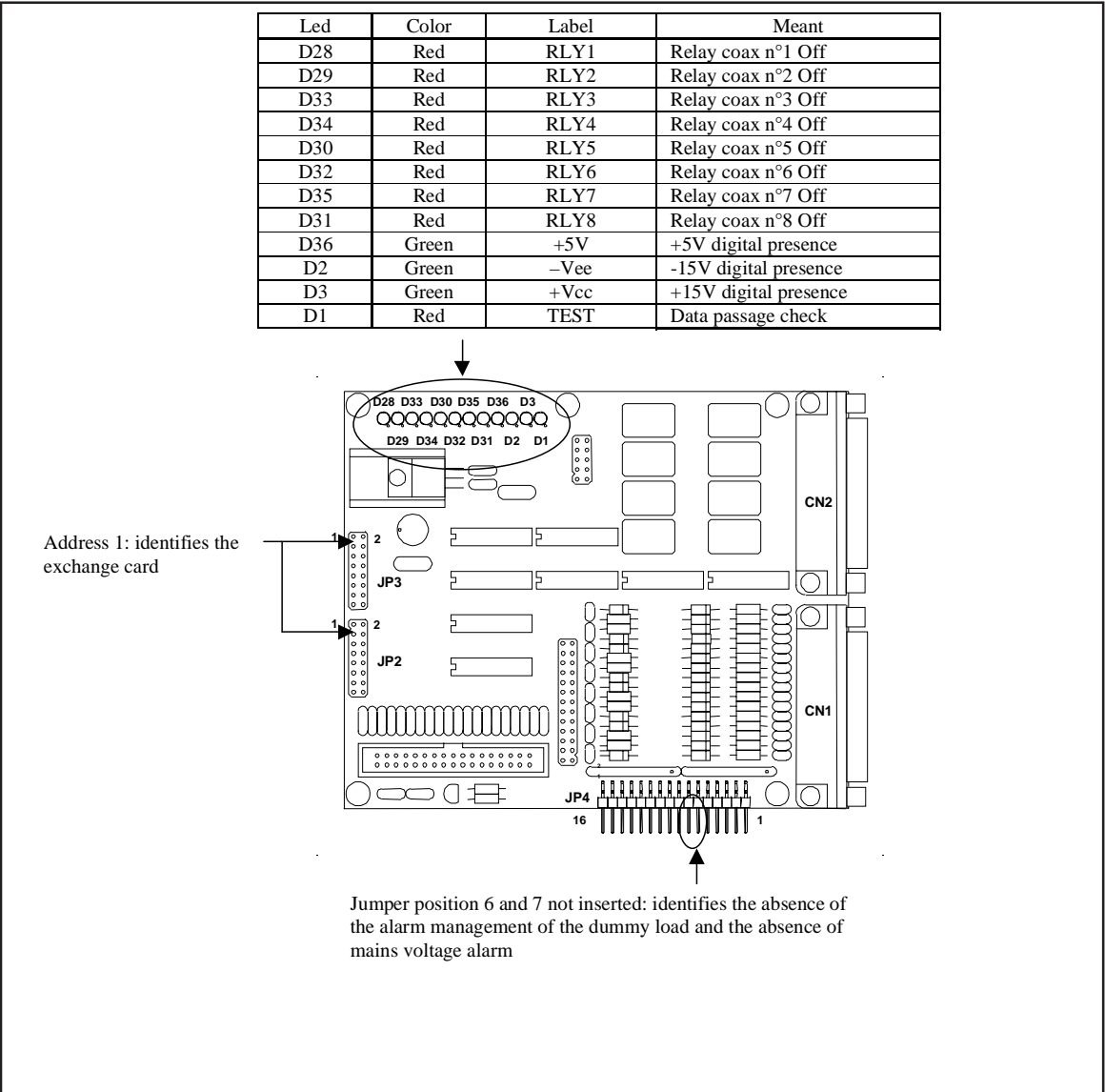

Pin number	Meant	Jumper on JP4
2	Digital power Good TXA	pos. 1 inserted
15	Digital power Good TXB	pos. 2 inserted
3	Low Power (-3dB)	pos. 3 inserted
16	Available	pos. 4 inserted
4	Available	pos. 5 inserted
17	Dummy load alarm	pos. 6 inserted
5	Absence of mains voltage (*)	pos. 7 inserted
18	Interlock (Inhibit)	pos.8 inserted
21	Manual exchange of TXA with TXB	pos. 9 inserted
9	Available	pos. 10 inserted
22	Available	pos. 11 inserted
10	Available	pos. 12 inserted
23	Manual exchange of TXB with TXA	pos. 13 inserted
11	Available	
24	Available	
12	Available	
1, 6, 7, 8, 13, 14, 19, 20, 25	GND	

(*) Only if the SCM has battery backup.

Use only one type of Power Good for each TX: analog (balanced analog input with intervention level adjustment), or digital (low active unbalanced digital/analog input).

The jumper on JP4 must always be inserted.

7.2.3 Rly Output

This connector makes the contacts of 8 bistable relay switches available in output. The figure shows a diagram of the relay home or Off position.

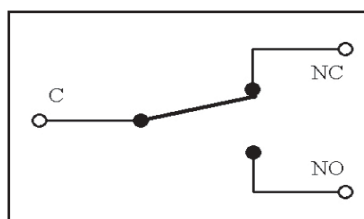

The maximum current which can be passed through the contacts is 500mA at 24V.

The contacts of the relay switches of this connector are used for commanding the switching on and off of both TXs.

Pin number	Relay	Interlock mode	On/Off mode
1 (C), 14 (NC), 2 (NO)	1	Interlock	Interlock EXC1
15 (C), 3 (NC), 16 (NO)	2	Interlock	Interlock EXC1
4 (C), 17 (NC), 5 (NO)	3	Interlock	Interlock EXC2
18 (C), 6 (NC), 19 (NO)	4	Interlock	Interlock EXC2
7 (C), 20 (NC), 8 (NO)	5	On/Off	PA1 ON
21 (C), 9 (NC), 22 (NO)	6	On/Off	PA1 OFF
10 (C), 23 (NC), 11 (NO)	7	On/Off	PAA ON
24 (C), 12 (NC), 25 (NO)	8	On/Off	PAA OFF
13		GND	GND

7.2.4 Description of connectors reserved PINs

This section deals with the connectors used by the device for the change over operations.

7.2.4.1 Balanced analog input 1 (Connector [4])

Type: DB25 female

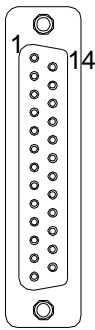

1	GND
2	TXA Power Good level (+)
3	TXB Power Good level (+)
4	GND
5	Spare Input No.3 (+)
6	Spare Input No.6 (+)
7	GND
8	Spare Input No.5 (+)
9	Spare Input No.6 (+)
10	GND
11	Spare Input No.7 (+)
12	Spare Input No.8 (+)
13	GND
14	TXA Power Good level (- or GND)
15	GND
16	TXB Power Good level (- or GND)
17	Spare Input No.3 (-)
18	GND
19	Spare Input No.4 (-)
20	Spare Input No.5 (-)
21	GND
22	Spare Input No.6 (-)
23	Spare Input No.7 (-)
24	GND
25	Spare Input No.8 (-)

7.2.4.2 Digital/analog input 1 (Connector [5])

Type: DB25 female

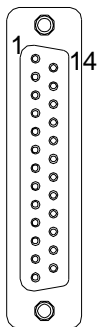

1	GND
2	TXA digital Power Good (jumper pos.1 inserted on telemetry card)
3	Spare Input
4	Spare Input
5	Mains power fault (jumper pos.7 inserted on telemetry card)
6	GND
7	GND
8	GND
9	Spare Input
10	Spare Input
11	Spare Input
12	Spare Input
13	GND
14	GND
15	TXB digital Power Good (jumper pos.2 inserted on telemetry card)
16	Spare Input
17	Dummy load interlock (jumper pos.6 inserted on telemetry card)
18	Spare Input
19	GND
20	GND
21	TXA manual change over on load with TXB connected to antenna (jumper pos.9 inserted on telemetry card)
22	Spare Input
23	TXB manual change over on load with TXA connected to antenna (jumper pos.13 inserted on telemetry card)
24	Spare Input
25	GND

7.2.4.3 Rly output 1 (Connector [6])

Type: DB25 female

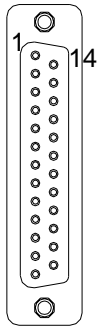

- | | |
|----|----------------------|
| 1 | Interlock 1 TXA (C) |
| 2 | Interlock 1 TXA (NO) |
| 3 | Interlock 2 TXA (NC) |
| 4 | Interlock 1 TXB (C) |
| 5 | Interlock 1 TXB (NO) |
| 6 | Interlock 2 TXB (NC) |
| 7 | Switch on TXA (C) |
| 8 | Switch on TXA (NO) |
| 9 | Switch off TXA (NC) |
| 10 | Switch on TXB (C) |
| 11 | Switch on TXB (NO) |
| 12 | Switch off TXB (NC) |
| 13 | Not connected |
| 14 | Interlock 1 TXA (NC) |
| 15 | Interlock 2 TXA (C) |
| 16 | Interlock 2 TXA (NO) |
| 17 | Interlock 1 TXB (NC) |
| 18 | Interlock 2 TXB (C) |
| 19 | Interlock 2 TXB (NO) |
| 20 | Switch on TXA (NC) |
| 21 | Switch off TXA (C) |
| 22 | Switch off TXA (NO) |
| 23 | Switch on TXB |
| 24 | Switch off TXB (C) |
| 25 | Switch off TXB (NO) |

7.3 Additional Standard Telemetry Card

This is a normal telemetry card, but the system management software uses it to control other parameters. The card internal address must always be the last one of the chain.

7.3.1 Balanced Analog Input

The balanced analog inputs of this special card are all available by connecting the signals as indicated in the specific chapter.

7.3.2 Digital/analog Input

The unbalanced digital/analog inputs of this special card are all available by connecting the signals as indicated in the specific chapter.

Pin number	Meant	Jumper on JP4
2	Name and type adjustable through PC	pos. 1
15	Name and type adjustable through PC	pos. 2
3	Name and type adjustable through PC	pos. 3
16	Name and type adjustable through PC	pos. 4
4	Name and type adjustable through PC	pos. 5
17	Name and type adjustable through PC	pos. 6
5	Name and type adjustable through PC	pos. 7
18	Name and type adjustable through PC	pos. 8
21	Name and type adjustable through PC	pos. 9
9	Name and type adjustable through PC	pos. 10
22	Available	pos. 11
10	Available	pos. 12
23	Available	pos. 13
11	Available	pos. 14
24	Available	pos. 15
12	Available	pos. 16
1, 6, 7, 8, 13, 14, 19, 20, 25	GND	

The jumper on JP4 must always be inserted at the corresponding position.

7.3.3 Rly output

All of the contacts of the relay switches of this connector are available and work in 3 ways:

- Generic: it switches to On and Off status statically.
- ToggleOff: always Off and switches to On for a short length of time.
- ToggleOn; always On and switches to Off for a short length of time.

Pin number	Relay	Mode
1 (C), 14 (NC), 2 (NO)	1	Adjustable through PC
15 (C), 3 (NC), 16 (NO)	2	Adjustable through PC
4 (C), 17 (NC), 5 (NO)	3	Adjustable through PC
18 (C), 6 (NC), 19 (NO)	4	Adjustable through PC
7 (C), 20 (NC), 8 (NO)	5	Adjustable through PC
21 (C), 9 (NC), 22 (NO)	6	Adjustable through PC
10 (C), 23 (NC), 11 (NO)	7	Adjustable through PC
24 (C), 12 (NC), 25 (NO)	8	Adjustable through PC
13		GND

7.3.4 Description of general alarms connector PIN

This section deals with the connector used by the device for the triggering of the general RVR alarms (settable via the "TELECON" program).

This connector refers to the last telemetry card inside the machine.

7.3.4.1 Digital/analog input

Type: DB25 female

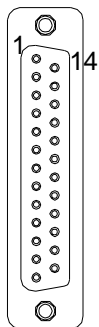

1	GND
2	Alarm custom 1 "MAINS" (jumper pos.1 inserted on telemetry card)
3	Alarm custom 3 "AUDIO EXT" (jumper pos.3 inserted on telemetry card)
4	Alarm custom 5 "CONT GROU" (jumper pos.5 inserted on telemetry card)
5	Alarm custom 7 "OPEN" (jumper pos.7 inserted on telemetry card)
6	GND
7	GND
8	GND
9	Alarm custom 10 "ALARM 12" (jumper pos.10 inserted on telemetry card)
10	Spare Input
11	Spare Input
12	Spare Input
13	GND
14	GND
15	Alarm custom 2 "USER" (jumper pos.2 inserted on telemetry card)
16	Alarm custom 4 "LINK SAT" (jumper pos.4 inserted on telemetry card)
17	Alarm custom 6 "FUEL" (jumper pos.6 inserted on telemetry card)
18	Alarm custom 8 "ALARM 10" (jumper pos.10 inserted on telemetry card)
19	GND
20	GND
21	Alarm custom 9 "ALARM 11" (jumper pos.9 inserted on telemetry card)
22	Spare Input
23	Spare Input
24	Spare Input
25	GND

7.4 Relay control card

This is the card from which the commands for coaxial relay switching are issued. The card internal address must always be number 7. Externally it is always connected to DB9 connectors EXT1...4 and to BNC connectors IN/OUT1...4 and COMMON.

Controls automatic change over operations:

Led	Color	Label	Meant
D5	Green	RLY1	Relay coax n°1 Off
D6	Green	RLY2	Relay coax n°2 Off
D7	Green	RLY3	Relay coax n°3 Off
D8	Green	RLY4	Relay coax n°4 Off
D3	Green	+Vcc	+15V analogic presence
D2	Green	-Vee	-15V analogic presence
D1	Red	TEST	Data passage check
D9	Green	+5V	+5V digital presence

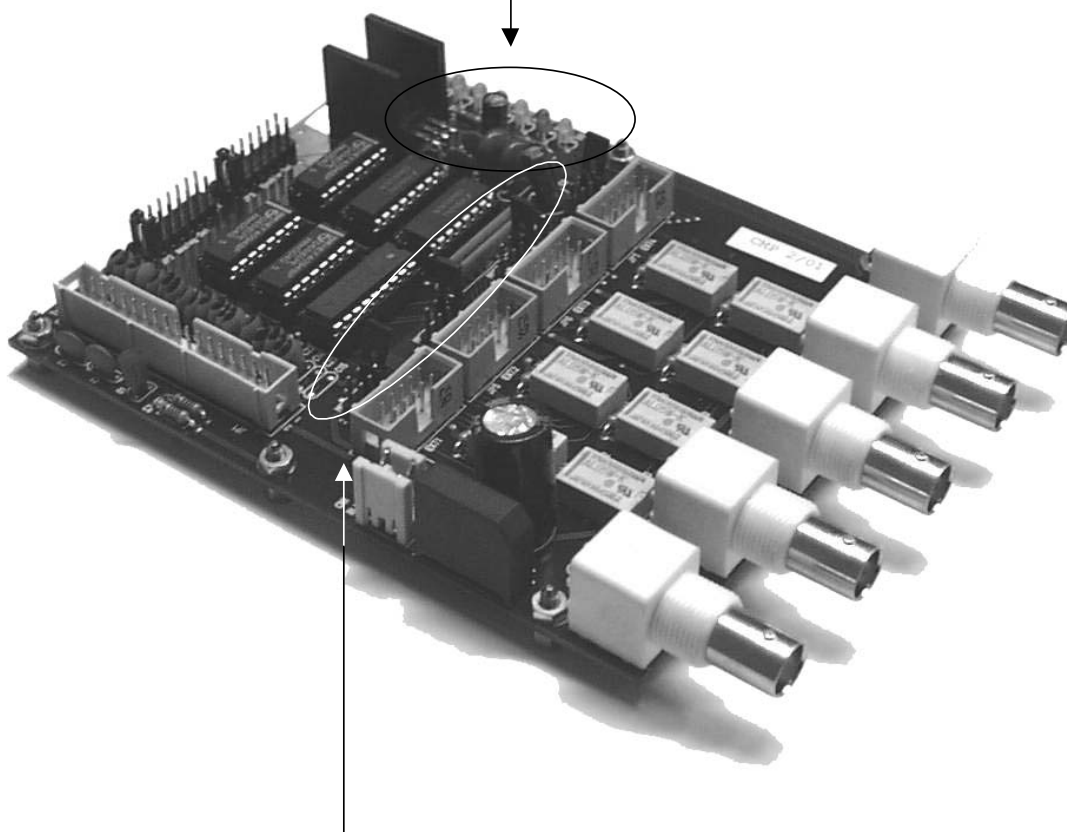

Jumper on JP8+JP11	Command mode
pos. 1-2	+12V or +24V DC
pos. 3-4	-12V or -24V DC
pos. 5-6	Common on pin 8

- by controlling in various ways ($\pm 12V$ DC, $\pm 24V$ DC, free switch) up to four coaxial relays and supervising their movements (3 digital inputs for each relay: limit switch position 1, limit switch position 2 and relay in movement);
- by switching the audio signal through five BNC connectors, connected as 4-position switches and one common connector.

7.4.1 Coaxial relay control voltage

To select the coaxial relay control voltage, move the terminal indicated by the arrow, located inside the device, in the bottom right-hand corner, between the toroidal transformer and the main ON/OFF switch.

The values available are 12V (figure on the right) or 24V (figure on the left).

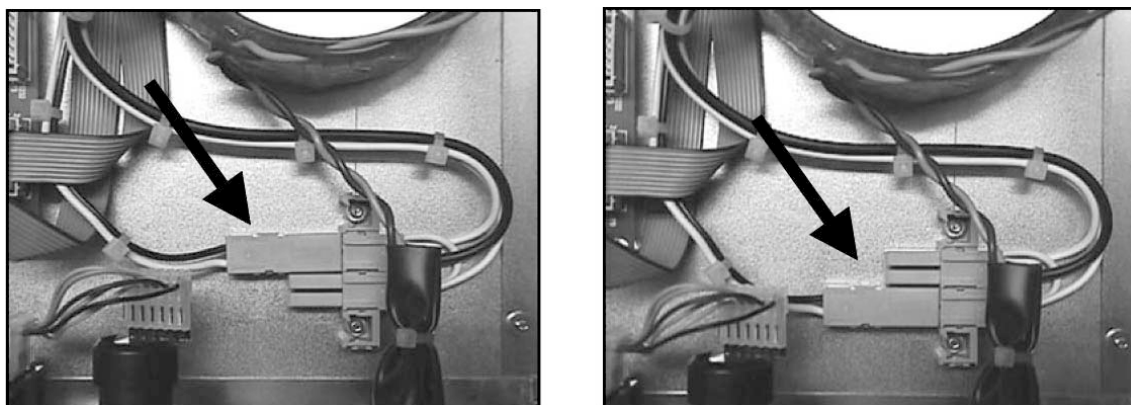

7.4.2 Coaxial relay control mode for SCM systems

Jumpers JP8, JP9, JP10 and JP11 in the figure are used to set the type of control for the coaxial relay used.

The coaxial relay can be controlled with positive voltage, negative voltage or by opening and closing a contact (table below); other possibilities can be implemented by using a connecting cable between the coaxial relay and the SCM which exploits the signals made available in output by the latter.

Jumper on JP8+JP11	Command mode
pos. 1-2	+12V o +24V DC
pos. 3-4	-12V o -24V DC
pos. 5-6	Common on pin 8

7.4.3 Ext. 1..4

The DB9 connectors carry the signals which control coaxial relay switching.

Type: DB9 female

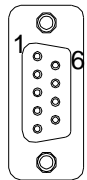
	1	Control voltage (+)
	2	Control voltage (-)
	3	Relay in position 1 (OFF)
	4	Relay in position 2 (ON)
	5	GND
	6	Switching to pos. 2 / NO
	7	Switching to pos. 1 / NC
	8	Common (when selected)
	9	Relay Switching

Pins 1 and 2 are outputs on which the relay control voltage is made available (12V or 24V DC); both contacts are floating as compared to all of the other positive or negative voltages.

Connected to pins 3 and 4 are the relay limit switches, two contacts which alternately close towards the ground when the relay is in the normal position (TX1 connected to antenna, pin 3 closed to ground) or switched (TXR connected to antenna, pin 4 closed to ground).

Pins 6 and 7 are the commands which cause the coaxial relay to switch from the normal position (Off) to the switched position (On) and vice versa; the type of command depends on the coaxial relay used and the position of the jumper on JP8 (for Ext. 1), JP9 (for Ext. 2), JP10 (for Ext. 3) or JP11 (for Ext. 4) on the relay control card, as well as the connecting cable between the SCM and the coaxial relay.

One of the possible positions of the control mode selection jumper makes available on pin 8 the common contact of a switch, of which pin 6 is the normally open (NO) contact and pin 7 is the normally closed (NC) contact.

Pin 9 is an open contact until switching begins, and is closed to ground when the relay has reached the new position.

7.4.4 IN/OUT 1..4 and COMMON

These BNC connectors are used to switch the audio signal parallel with the change over of the TXs connected to the antenna.

Connected to the BNC INPUTS/OUTPUTS are the respective TXs input audio signals, whilst COMMON constitutes the TXR audio input.

When the conditions which require the change over of the TXR connected to the antenna arise, the audio signal at the faulty TX input is simultaneously switched to the COMMON connector.

These connectors are not used in the SCM1+1: the audio signal is simultaneously connected to the inputs of TX1 and TXR.

7.4.5 Indicator lights

The green LEDs D5-D8 indicate the status of coaxial relay switching: they are lit when the corresponding relay is in the normal position.

The other green LEDs (D2, D3 and D9) indicate the presence of the power supply voltages (-15V and +15V analog, +5V digital).

The last LED, the only red one, controls communications between the CPU and the card: when the LED flashes the data is transferred correctly.

Led	Color	Etichetta	Significato
D5	Green	RLY1	Coax relay n°1
D6	Green	RLY2	Coax relay n°2 Not connected
D7	Green	RLY3	Coax relay n°3 Not connected
D8	Green	RLY4	Dummy load ventilation command
D3	Green	+Vcc	+15V analogic presence
D2	Green	-Vee	-15V analogic presence
D1	Red	TEST	Data passage check
D9	Green	+5V	+5V digital presence

7.5 Description of service connectors PIN

7.5.1 RS232 Interface

The DB9 connector in question is the SCM and TLC communications port through which the system is controlled remotely.

The meaning of the signals present at the pins is immediate. Notice that the CTS is not managed, in the sense that it is always active.

Type: DB9 female

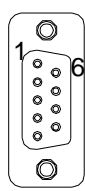
	1	N.C.
	2	TX_D
	3	RX_D
	4	N.C.
	5	GND
	6	+15V
	7	N.C.
	8	CTS
	9	N.C.

7.5.2 I²C Interface

The I²C bus serial interface is used to transfer data between the SCM, the PTX-LCD series exciters, the TLC telemetry system and the PJ-LCD amplifiers.

Pin 2 carries the data (Serial DATA), pin 3 the sampling clock (Serial CLOCK).

Pin 4 is a device external reset input (low active).

Type: DB9 female

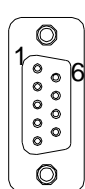
	1	GND
	2	SDA
	3	SCL
	4	Reset Esterno
	5	GND
	6	N.C.
	7	N.C.
	8	N.C.
	9	N.C.

8. Identification and Access to modules

8.1 CPU card

The heart of the device is the CPU card, which manages and processes all data from the telemetry cards and the relay control card, as well as data from the devices connected via the I2C bus serial interface.

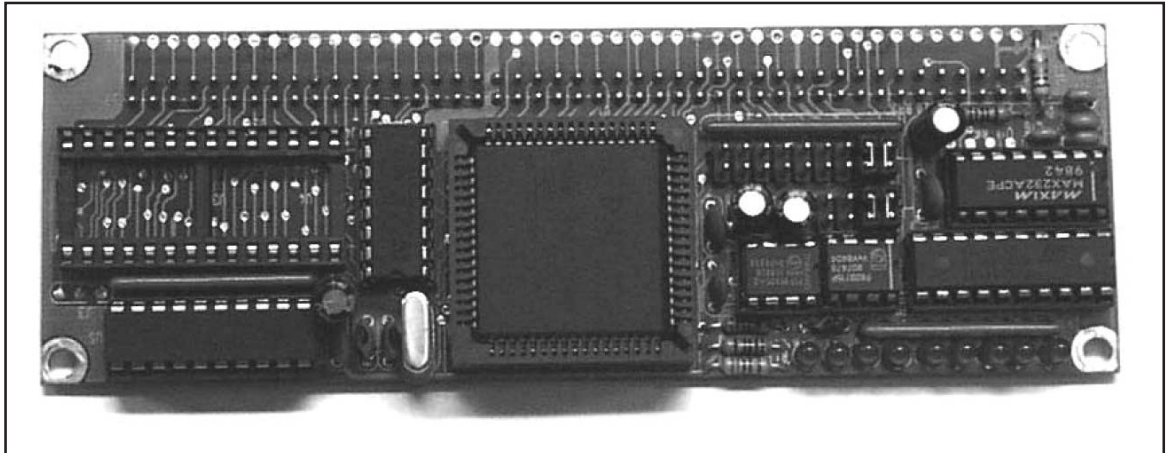

Another important function is the management of the graphical interface, which makes setting and execution of the various operations on the system particularly easy.

8.2 Panel card

This card is fitted with all the connectors in which to insert the CPU card, the connector that carries data and power supply to the telemetry cards and the communications connectors.

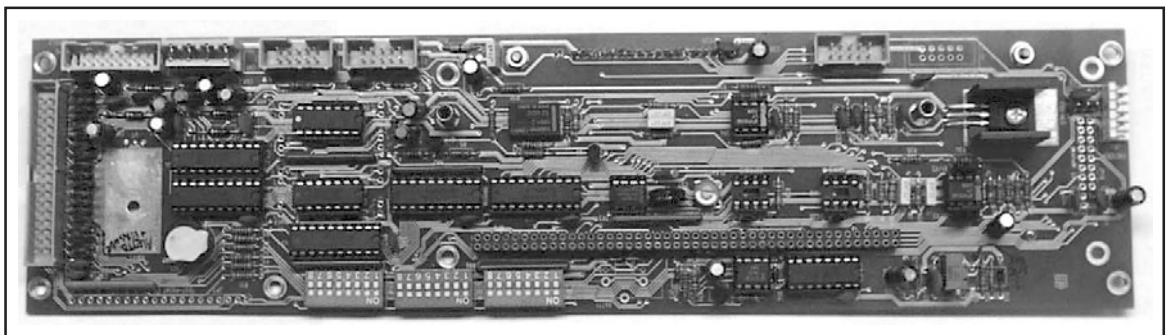

Includes a liquid crystal graphics display, the encoder and several LEDs. This card is not present in model TLC300.

8.3 Telemetry card

Acquires telemetry data in two ways:

- balanced analog with a limit voltage which can be adjusted between 2V and 12V using a trimmer (eight inputs);
- unbalanced analog with a limit voltage fixed at 5V, or digital with 2.2 KOhm internal pull-up which can be switched on using a jumper (sixteen inputs).

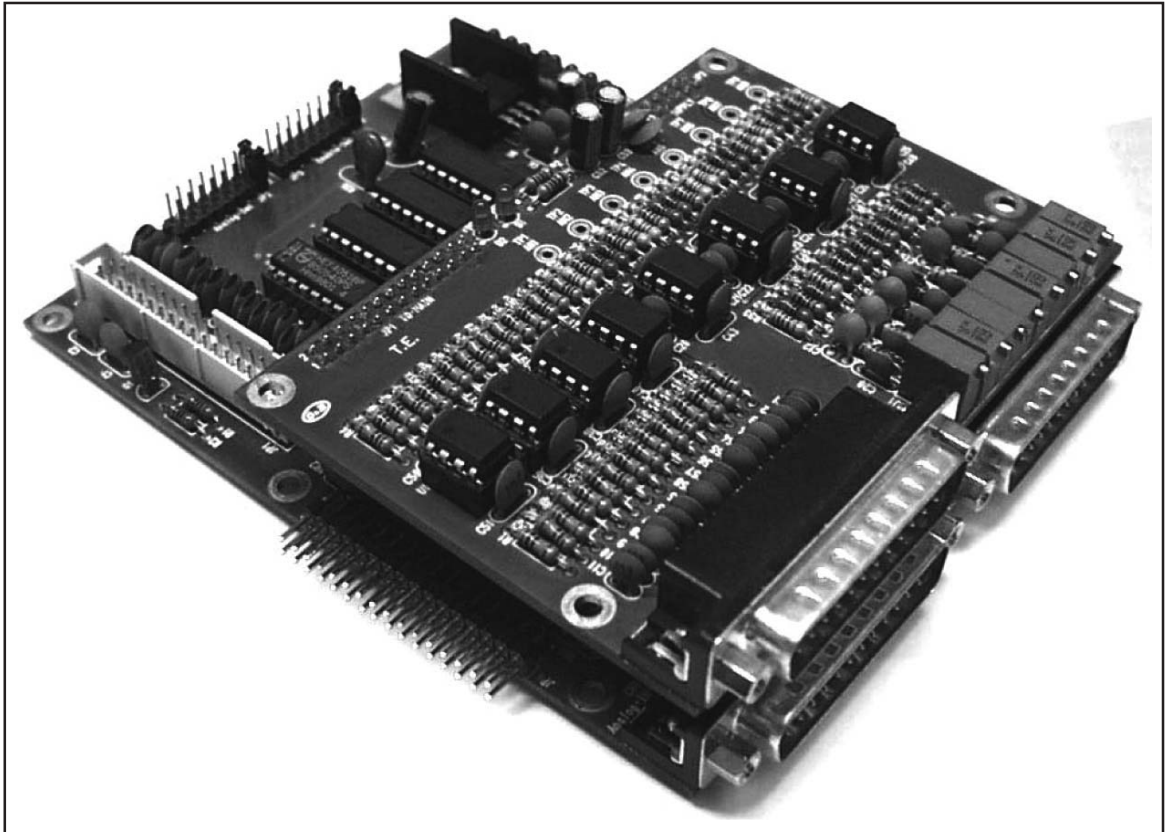

The telemetry card also makes the contacts of eight relay switches available in output (max. 24V - 0.5A).

8.4 Relay control card

Controls automatic change over operations:

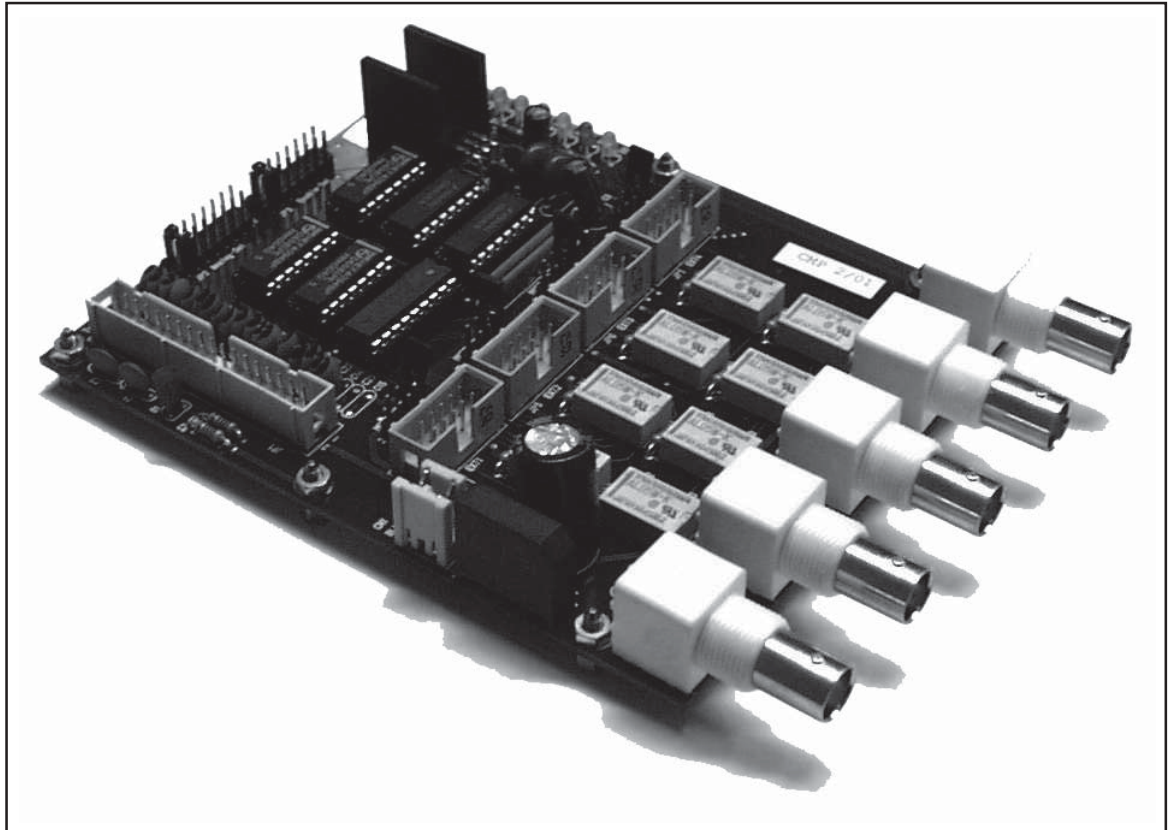

- by controlling in various ways ($\pm 12V$ DC, $\pm 24V$ DC, free switch) up to four coaxial relays and supervising their movements (3 digital inputs for each relay: limit switch position 1, limit switch position 2 and relay in movement);
- by switching the audio signal through five BNC connectors, connected as 4-position switches and one common connector.

This type of card is not present in the devices for telemetry only (TLC300 and TLC2000).

8.5 Power supply

Alternating current with mains voltage 100-120-220-240V which can be selected externally, or 24V direct current.

The power supply unit which powers the various cards in the device is of the switching type.

Models SCM1+1 and SCMN+1 also have a terminal board for selection of the coaxial relay control voltage (12V or 24V).

This page was intentionally left blank

9. Card settings

9.1 Setting of the card internal address

A unique address must be assigned to each card, whether relay control or telemetry, which characterizes it and makes it unique for the CPU. Therefore insert a jumper on each of the JP2 and JP3 connectors in the position indicated in the table below.

Address	jumper on JP2	jumper on JP3	Board type
1	1-2	1-2	Base Telemetry
2	3-4	3-4	Base Telemetry
3	5-6	5-6	Telemetry
4	7-8	7-8	Telemetry
5	9-10	9-10	Telemetry
6	11-12	11-12	Telemetry
7	13-14	13-14	Relais command
8	15-16	15-16	Relais command

Keep in mind that:

- a fixed address interval is assigned to every type of card;
- addresses 1 and 2 are reserved to standard telemetry cards No. 1 and No. 2, respectively;
- address 7 is reserved to the relay control card;
- always assign the lowest free address for each type.

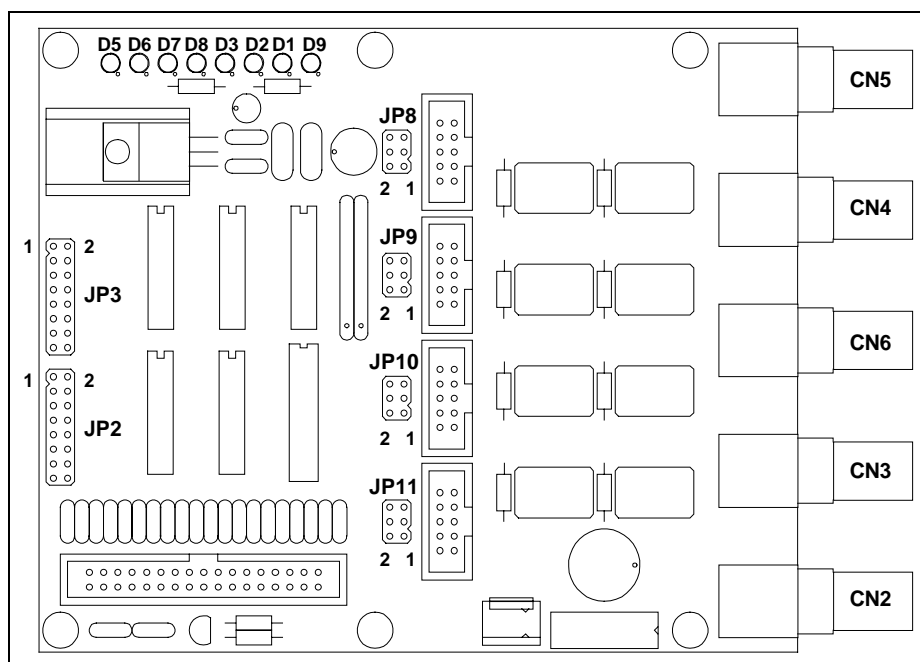

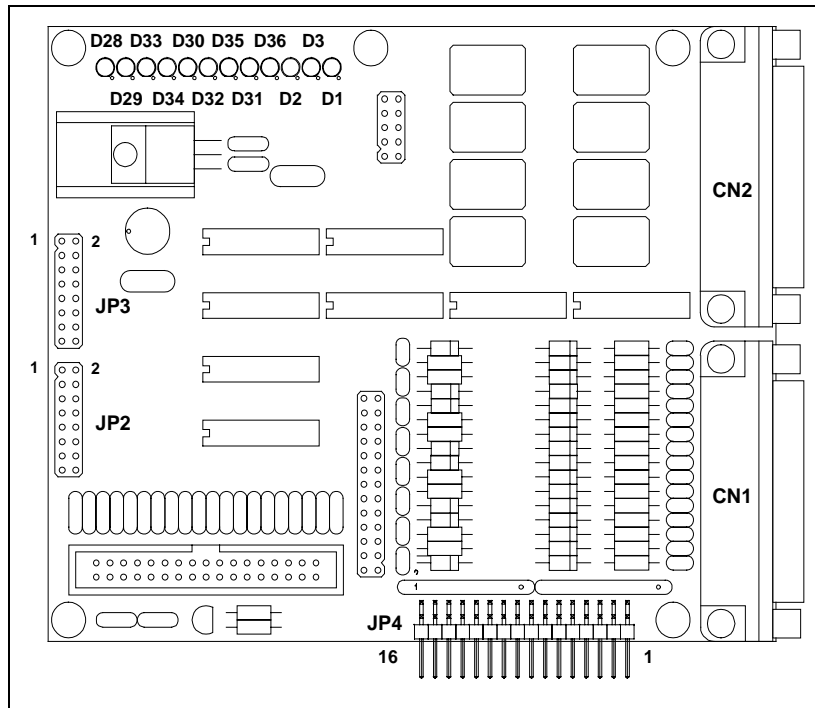

9.2 Setting of the Dip-Switches

The figure shows a part of the panel card that highlights the 24 Dip-Switches, divided into 3 parts of 8 switches each, numbered from one to three. Use the following numbering to determine the position of the individual switch:

- Sw1.1: this is the first switch of the first part.
-
- Sw8.3: this is the last switch of the last part.

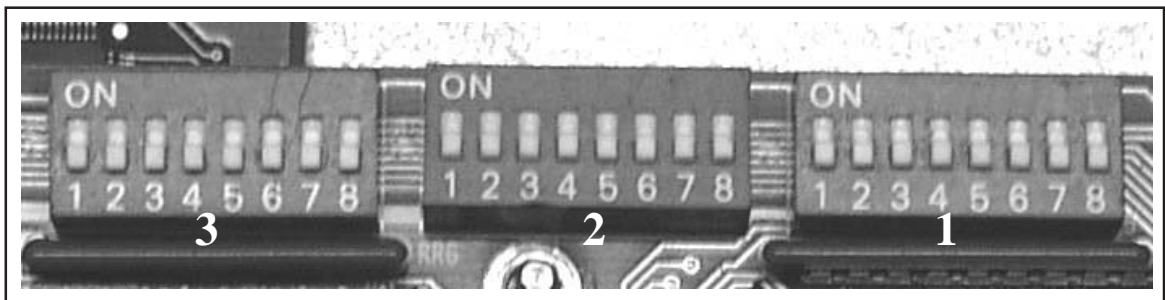

9.2.1 Setting of the Dip-Switches

9.2.1.1 Number of peripheral units in I²C bus

The number of the devices connected via I²C bus is determined by Dip-Switches from Sw1.1 to Sw1.8, in binary format.

	Sw 1.1	Sw 1.2	Sw 1.3	Sw 1.4	Sw 1.5	Sw 1.6	Sw 1.7	Sw 1.8
0								
1	On							
2		On						
3	On	On						
4			On					
5	On		On					
6		On	On					
7	On	On	On					
8				On				
				...				
16					On			
				...				
32						On		
				...				
64							On	
				...				
128								On
				...				

9.2.1.2 Enabling of Interlock input

To enable this input, set switch 2.1 to ON. The operation of this input is defined in the following chapter and is enabled every time the device is configured with Dual Exciter in change over mode.

9.2.1.3 Enabling of Low Power input

To enable this input, set switch 2.2 to ON. The operation of this input is defined in the following chapter and is enabled every time the device is configured with Dual Exciter in change over mode.

This page was intentionally left blank

10. Software description

The software which manages the SCM systems was designed to allow easy consultation and setting of the parameters relative to the system supervised by the device.

For this reason, a pyramid structure is used which, starting with the main screen page when the device is powered up, allows access to increasingly specific sub-menus using the encoder on the front panel.

To change the various items, press the encoder when the cursor is positioned on the desired parameter, then turn it to scroll through the values which can be set.

10.1 Flow chart

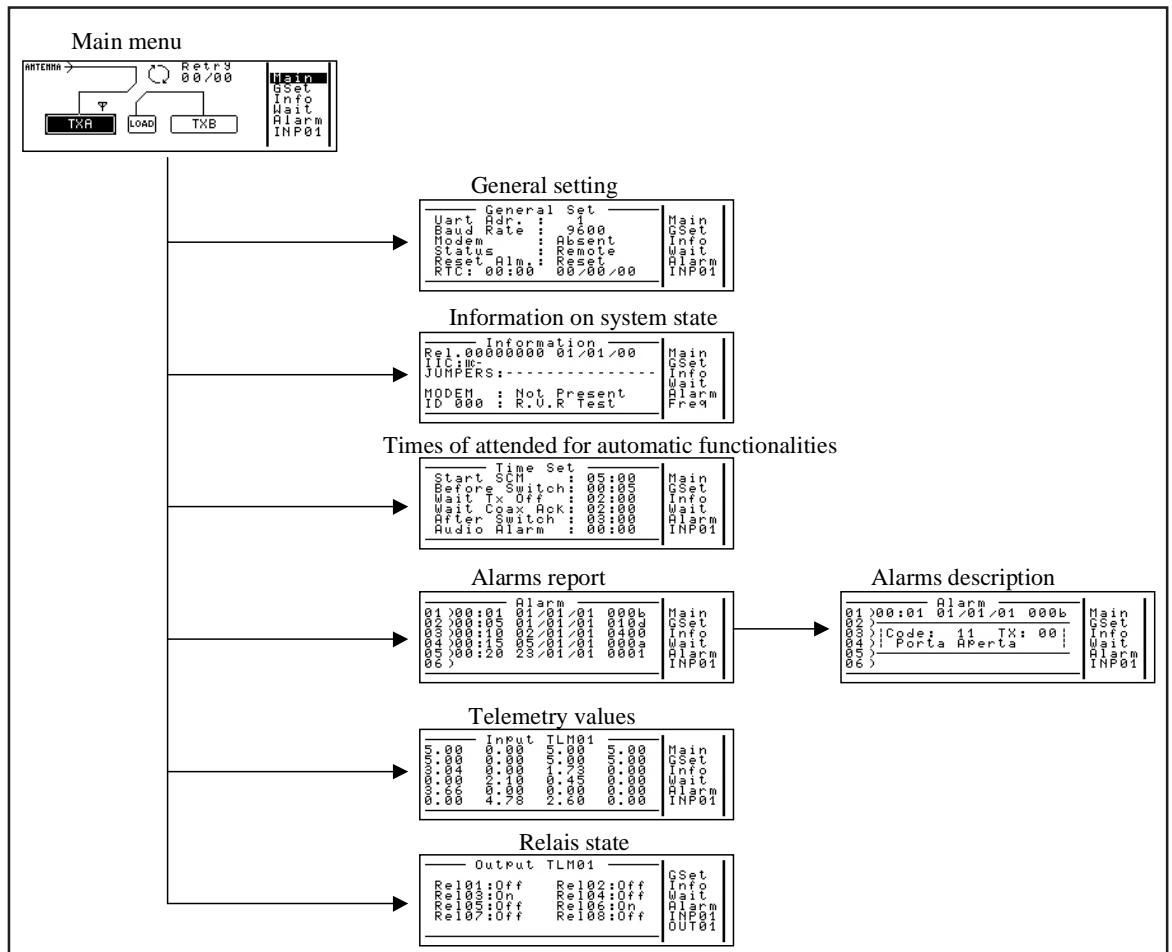



The figure shows the screen pages in the SCM 1+1.

10.2 Main - Schermata principale

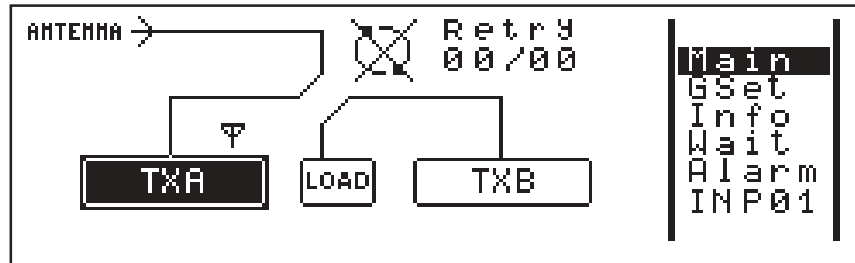
When the device is switched on using the ON/OFF switch on the front panel, the LCD displays a screen page indicating the overall situation of the system transmitters and the position of the coaxial change over relay.



Three different symbols may appear above the transmitter symbols:

-  (exclamation mark): indicates that automatic change over has occurred (excluding TXB);
-  (antenna): power good; indicates TXA output power;
- : indicates that the presence of a PTX-LCD was detected and the communication occurs via IIC bus.

Turn the encoder and an arrow-shaped cursor moves to indicate the symbols of the TXs, the coaxial relay, the manual/automatic symbol and the "RETRY" number or the scroll menu on the right-hand side of the screen. Press the encoder to obtain a different effect depending on the item indicated by the cursor at that moment, i.e.:

- TX: switches the selected TX on or off;
- Relay: effects manual change over between the selected TX connected to the relay and the TXB;
- Automatic/manual icon: switches the device in automatic or manual change over mode;
- Retry: defines the number of automatic change over operations before switching to the manual change over mode;
- : Fault main, indicates current is missing and disables the automatic change over.
- Scroll menu: displays a bar which scrolls through the menu and is used to select one of the various sub-menus.

Use the scroll menu to open the screen pages to set and/or read the various system parameters:

- Main: main screen page;
- GSet: general settings;
- Info: read information about system configuration;



- Wait: set the change over time;
- Alarm: read alarm report;
- INP01, 02, ..., N: read analog and digital input values (there are as many as there are relay control and telemetry cards in the system);
- OUT01,02, ... , N: read relay output status (there are as many as there are relay control or telemetry cards in the system).

10.2.1 Main - Main screen page in Dual Exciter configuration

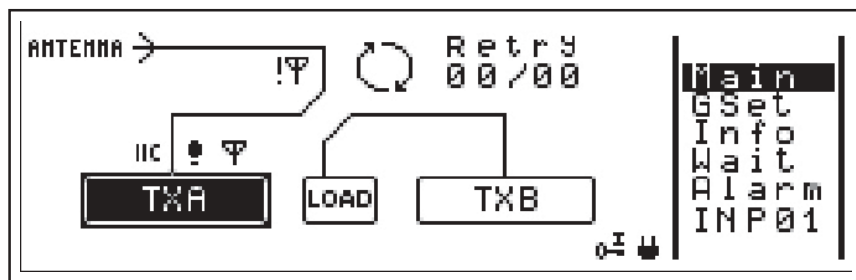
When the SCM1+1 is configured in "Dual Exciter" mode, two more signals must be monitored.



Therefore the following symbols could be displayed if an alarm is triggered:

- : indicates that the SCM is in wait condition in the event one of the two transmitters switches off, closing the INTERLOCK signal to ground;
- : indicates low power if the transmitter power has dropped below the adjustable level of Power good 2.

10.3 GSet - General settings

This menu is used to set the general and communication parameters of the change over system.

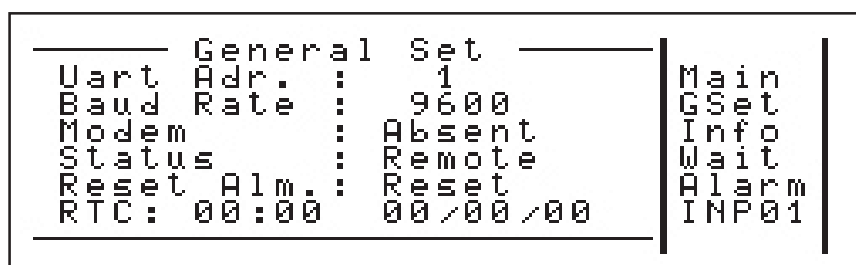

- Uart Adr.: sets the address of the change over unit; this is important in a system in which there are several telemetry and remote control devices operating in series;
- Baud Rate: sets the data transmission speed, from 1200 to 19200 baud.
- Modem: sets the type of modem:
 - 1) Not Present: no modem connected;

- 2) Present: data-phone modem;
- 3) Pager: data-phone modem with alarm indication in the form of pager messages;
- 4) GSM: GSM modem with alarm indication in the form of SMS messages;
- Status: sets the system control mode:
 - 1) Remote: remote control;
 - 2) Local: local control;
- Reset Alm.: completely clears the alarm report and switches off the "GENERAL ALARM" LED on the main panel;
- RTC: allows you to set the time and date of the internal Real Time Clock.

10.4 Info - Information about system configuration

Displays some parameters characteristic of system configuration. These parameters cannot be modified.

```

----- Information -----
Rel.00000000 01/01/00      Main
IIC:IIC-              GSet
JUMPERS:-----         Info
                          Wait
MODEM  : Not Present     Alarm
ID 000  : R.V.R Test     INP01
-----
  
```

- Rel. : identifies the software release number and the issue date;
- IIC: a symbol is displayed next to the number that represents address I2C:
 - - (minus): indicates that the device does not respond to the requests and as such there is no communication.
 - IIC: indicates that the device is present and communicates correctly.
- If there is no symbol this means that there are no devices that can communicate with this mode or that the dip-switches, relative to the number of devices present, have not been set correctly.
- Info: if a modem is present, the initialization and operating stages are specified;
- Modem : indicates that the modem is or is not present.

10.5 Wait - Setting the time

Use this menu to set the time of the individual change over procedures, the wait time of the device at start-up and the audio alarm delay.

```

----- Time Set -----
Start SCM          : 05:00
Before Switch     : 00:05
Wait Tx Off       : 02:00
Wait Coax Ack     : 02:00
After Switch      : 03:00
Audio Alarm       : 00:00
-----
Main
GSet
Info
Wait
Alarm
INP01
-----

```

The following items can be changed:

- **Start SCM:** defines the period during which the device remains in a status of inactivity after being started up. Said time is also used if power failures occur so that when power is supplied again the transmitters can attain full power.
- **Before Switch:**
defines the wait period from the moment in which a transmitter malfunctions, before initiating the change over procedure.
- **Wait TX Off:**
defines the maximum wait period for the switching off condition of the faulty transmitter.
- **Wait Coax Ack:**
defines the maximum wait period for the coaxial relay to stabilize in the correct position.
- **After Switch:**
defines the maximum wait period after the completion of the change over procedure to permit the transmitter, which was switched on during the procedure, to attain full power.
- **Audio Alarm:**
If greater than 0, it enables alarm detection and delays its indication, otherwise it disables said alarm.

10.6 Alarm - Alarm report

Displays the time and date of the last six alarm events detected by the SCM.

```

----- Alarm -----
01 )00:01 01/01/01 000b
02 )00:05 01/01/01 010d
03 )00:10 02/01/01 0400
04 )00:15 05/01/01 000a
05 )00:20 23/01/01 0001
06 )
-----
Main
GSet
Info
Wait
Alarm
INP01
-----

```

Select the desired alarm and another screen page appears showing the alarm code, the transmitter affected and the cause of the alarm event indication.

```

Alarm
01 >00:01 01/01/01 000b
02 >
03 >|Code: 11 TX: 00|
04 >|Porta APerta |
05 >
06 >
Main
GSet
Info
Wait
Alarm
INP01

```

10.7 INP01, ..., N - Card input values

The scroll menu contains as many items of this type as there are relay control or telemetry cards in the system supervised by the SCM.

This menu is used to display all of the values of the analog or digital inputs on the selected card (between around 0 and 5V).

```

Input TLM01
05.00 0.00 5.00 0.00
03.00 0.00 5.00 0.00
04.00 0.00 1.73 0.00
0.00 2.10 0.45 0.00
0.66 0.00 0.00 0.00
0.00 4.78 2.60 0.00
Main
GSet
Info
Wait
Alarm
INP01

```

The first two lines (8 values) refer to the balanced analog inputs; the other four (16 values) refer to the unbalanced digital/analog inputs.

The first, "INP01", always refers to the standard telemetry card; the last shows the values of the relay control card digital inputs.

To find out which devices the values of the other cards refer to (if fitted), consult the station technical manual.

10.8 OUT01, ..., N - Relay output status

The scroll menu contains as many items of this type as there are relay control or telemetry cards in the system supervised by the SCM.

This menu is used to display the ON/OFF status of the relays on the selected card.

```

----- Output TLM01 -----
Rel01:Off   Rel02:Off
Rel03:On    Rel04:Off
Rel05:Off   Rel06:On
Rel07:Off   Rel08:Off
-----
GSet
Info
Wait
Alarm
INP01
OUT01
-----

```

The first, "OUT01", always refers to the standard telemetry card; the last shows the status of the coaxial relays.

To find out which devices the values of the other cards refer to (if fitted), consult the station technical manual.

The relay switches on the telemetry cards can be controlled only using the remote control software. Enabling of local control is optional.

This page was intentionally left blank

Appendix A **Descrizione del software Telecon / *Telecon software description***

Questa parte del manuale contiene informazioni e dettagli tecnici riguardanti l'uso del software di telecontrollo per i sistemi SCM-TLC.

This part of the manual contains informations and technical details about the use of remote control software for SCM-TLC systems.

Table of Content

1. Remote Control Software Description	1
1.1 Functioning	1
1.2 Installation	1
1.3 Esecution	2
1.4 Functioning	4
1.5 Programation of a remote station	11
1.6 Structure of the stations.	14
1.7 Structure of the database	16
1.8 Creation of groups and stations	19
1.9 Creation and editing of the Personalization window	24
2. Monitoring Telemetry Stations	33
2.1 Functioning	33
2.2 Installation	33
2.3 Telemetry software	33
2.4 Scheduling functions	37
2.5 Technical information concerning the realization	39
3. Interconnection example (TLC)	43
3.1 In Digital with RVR's LCD Equipment	43
3.2 In Analogic with RVR's LCD Equipment	44
3.3 In Analogic with Generic Equipment	44
4. Commands from remote (TLC)	47
5. Massages on the Modem State (only TLC2000)	49

1. Remote Control Software Description

1.1 Functioning

The program exploits the serial connection through RS232 with a modem for the connection to a remote RVR station.

Each RVR station is composed of several parts called "modules" that can be called sequentially in order to receive and send data. These data are interpreted in order to obtain the measurement value to which they refer.

The connection is always realized starting from the first module, either when the station is composed of several modules (TLC300, TLC2000, SCM) or when the station is composed of a single module (PTXLCD).

The maximum connection speed is 19200 baud when transmitting with a traditional telephonic line and 9600 baud when transmitting with a GSM telephone line.

1.2 Installation

- Insert the CD-ROM in the CD-ROM player.
- From the desktop, open "Program Manager".
- Double click on the CD-ROM player icon to display its content.
- If you are using Windows2000, double click on the program "setup_telecon_win2k.exe" to install the software
- If you are using Windows95, 98 or Me, double click on the program "setup_telecon_win9x.exe" to install the software
- It may be required to install the necessary drivers for the access to data, before installing the software.
- When the installation is completed, the "Tlc32bit" group which contains the programs: "Telecon 32bit" and "GSM Init" will be created, then the connection icons will appear on the Desktop.

System Requirements:

- Windows 95 ®, Windows 98 ® either first or second edition, Windows ME ®, Windows NT ® and Windows 2000 ®.
- Processor:
Intel Pentium ® 75 MHz or better.
- Minimum Memory required:
16MB Ram.
- Minimum capacity on Hard Disk required:
50Mb.

1.3 Esecution

Double click on the "Telecon 32bit" icon present on the desktop or select Telecon 32bit from the "Start" menu -> Programs -> TLC32bit -> ", in order to start the program.

1.3.1 How to choose and configure a station

In the main window it is possible to choose the station you wish to call and edit the parameters that refer to communication.

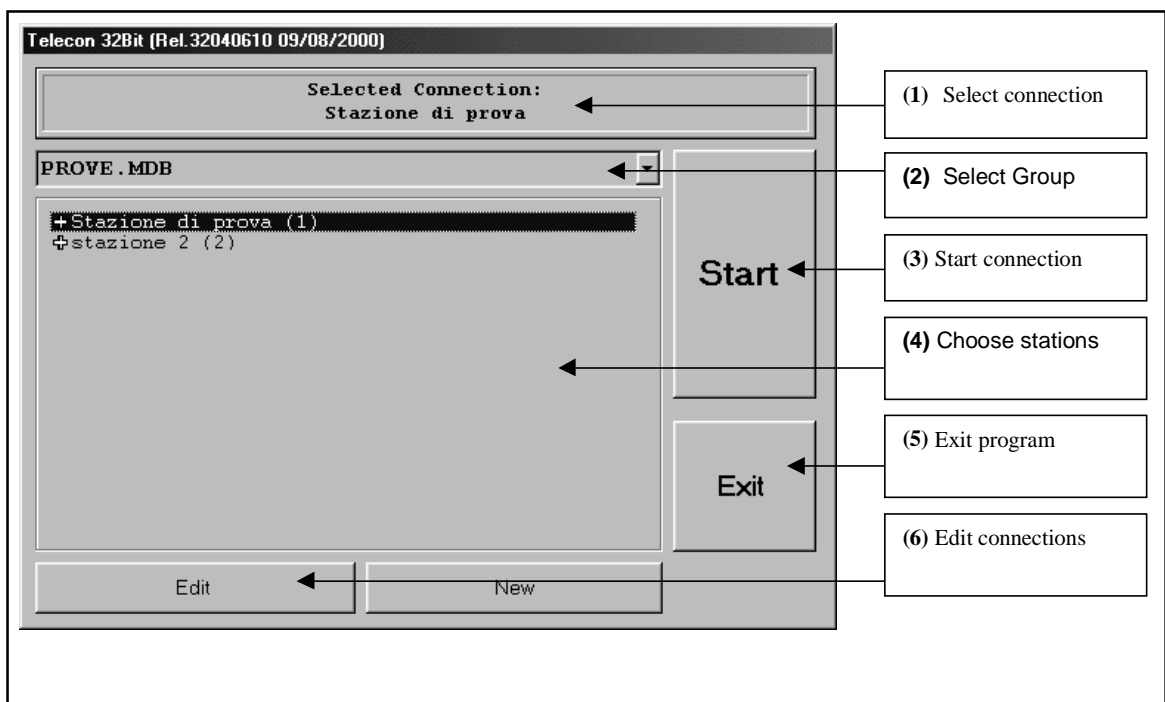

- The window showing the "Chosen connection " (1) indicates which station will be called when the "START" button is selected (3).
- When clicking on "Select Group" menu (2) it is possible to choose between the different groups of stations (if saved)
- The "START" button (3) launches the call to the station.
- The "EXIT" button (5) exits the program.
- When clicking on "Select stations" (4) it is possible to choose among the present stations which one will be called, the selection inside the window will then change (1).

When pressing the cross situated on the left side of the name of the station, the description of the station is displayed.

The station is composed of 2 menus:

- "Connection Configuration" containing the connection parameters (init string of the modem, telephone number, etc..),

- "Station Configuration" containing the composition of the station.

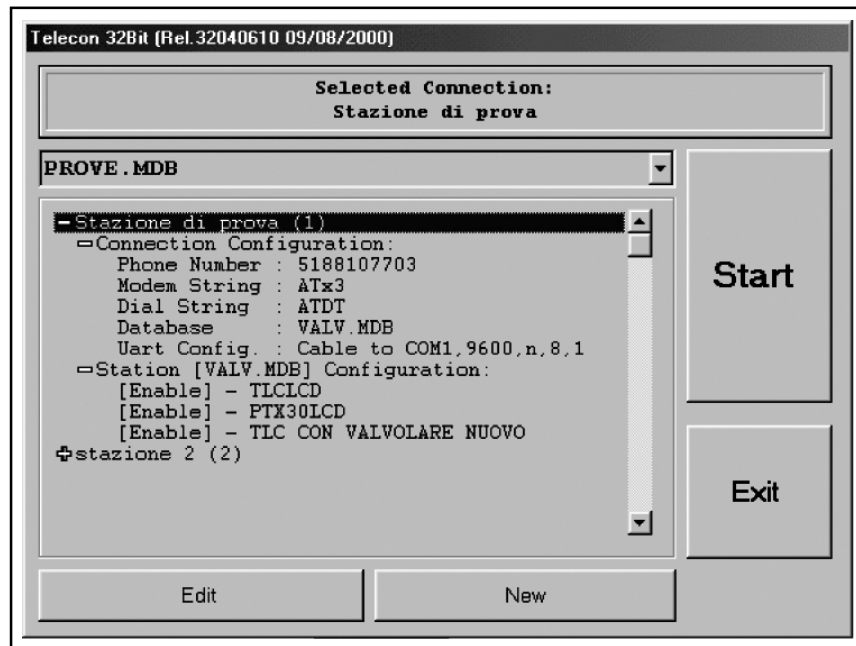

- When you click on the "Edit connections" button (6) the window shown in fig 3 is displayed, from there you can edit the different connection parameters of each station.

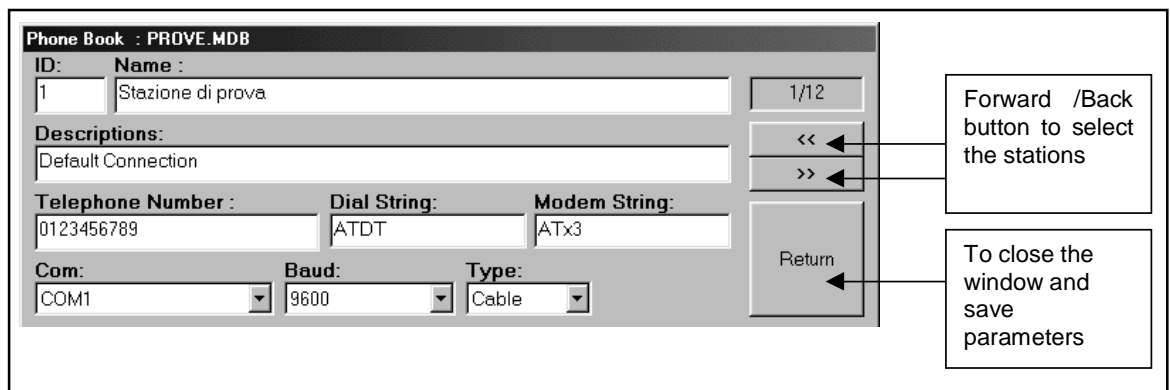

The first time you use the software, it is necessary to enter:

- The telephone number,
- The COM port used,
- the Baud rate,
- the type of connection (direct through cable, through telephonic modem or GSM).

In order to avoid functioning problems, we will not give instructions concerning stations

building. Please kindly contact R.V.R. S.p.A. if you wish to put additional stations.

1.3.2 Connection

When the station is selected, press "START" (3).



The connection window is displayed, and it will remain displayed until the connection is completed.

In case the telephone line is busy, it will be possible to make a new connection attempt by pressing the "Retry" button.

The "More Detail >>" button enables to get further information concerning the status of the station.

The "Exit" button brings you back to the "station selection" window.

1.4 Functioning

The program has 2 interfaces:

1.4.1 How to personalize

The first interface called "Personalization" is displayed when the station is connected.

This interface is easy to use and it enables the user to check, whenever he wants, the status of the station in a fast way (fig. refers to the personalization of a VJ25000).

Apart from the various indicators either analogical or digital and the alarm leds, there are also a few buttons that enable to select most frequently needed functions (switch on/off, alarm reset).

When pressing one of these buttons, the user is asked to confirm the current function selected.

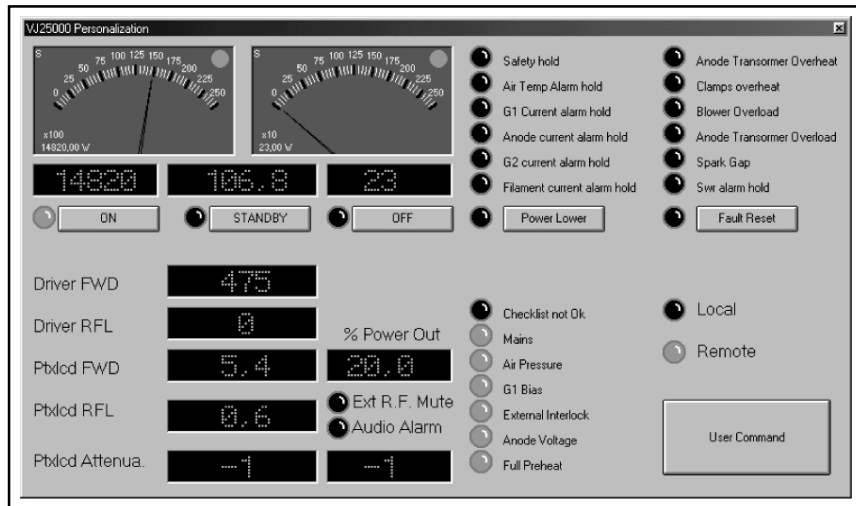

In order to change some levels such as attenuation of the inputs and the output power percentage of the PTXLCD, double click on the measurement that you wish to change and insert the new value required.

If you wish to create or modify the personalization, please refer to Chapter "Creation and editing of the personalization window".

1.4.2 Standard interface

Behind the Personalization window, there is the standard Telecon interface.

It is composed of 5 main areas:

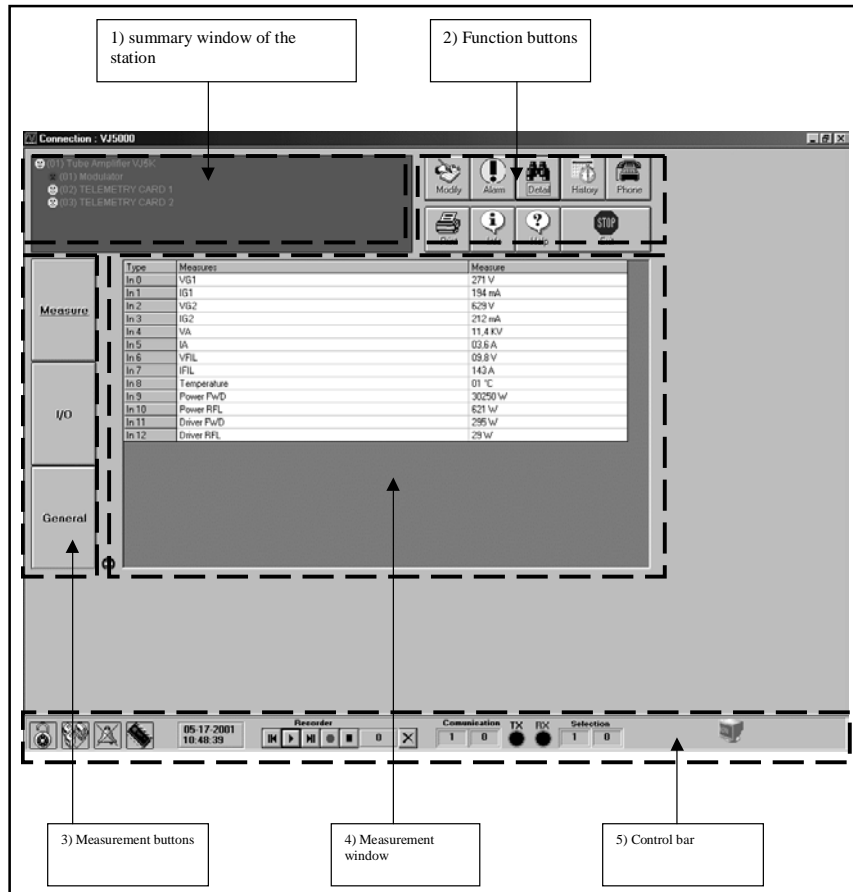

1) **Summary window of the station**



As you can understand from its name, it indicates the parts that compose the station (obviously as far as telemetry is concerned).

When you click on the components (modules), the window with the data concerning measurements are displayed (3).

2) Function of the different buttons



- "Alarm" button:

The "Alarm" button enables to open the window showing the chronological list of the alarms that may have appeared (only for SCM and TLC units).

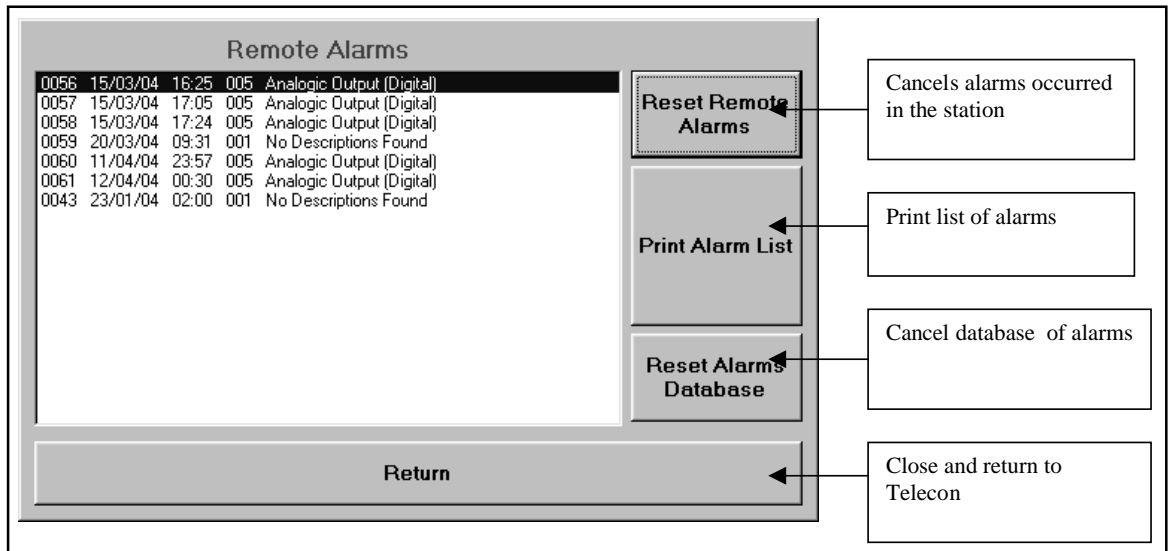

Apart from being saved in the station, the occurred alarms are included in the database of the station itself.



- "Detail" button:

The "Detail" enables to open the personalization (See point 10.4.1).



- "History" button:

The "History" button enables to open the window containing the schedule (this function is not available in this software version).



- "Print" button:

The "Print" button enables to print the status of the station: a page for each module with the different measurements as displayed on the measurement window (3).



- "Info" button:

The "Info" button enables to open a window in which it is possible to select the modules in order to get information concerning the software and hardware versions, the number of analogical and digital I/O.

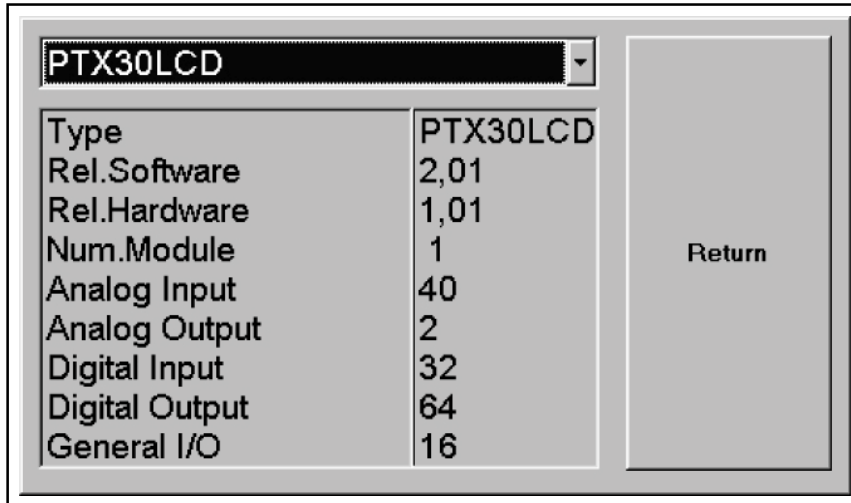

- "Phone" button:



The "Phone" button enables to open the window showing the set-up of the telephone numbers saved in the memory of the SCM.

N.B. This option is only valid if the SCM is connected to an analogical modem.

- "Help" button:



The "Help" button enables to open the online guide.

- "Exit" button:



The "Exit" button enables to exit the program.

3) **The buttons to select measurements:**

- "Measure" button:



The "Measure" button enables to visualize the inputs, either balanced analogical or analogical/digital, in the "Measurement window "(4).

- Il tasto "I/O":



The "I/O" button, enables to visualize the outputs of the "Measurement window "(4).



- “General” button:

The "General" button, enables to visualize the general measurements of the "Measurement window "(4).

4) The measurements window:

Measurement type	Measurement name	Received value
Type	Measures	Measure
In 5	RDS	0 %
In 2	Modulazione	5 KHz
In 6	Varicap Voltage	8,45 V
In 7	Negative Voltage	-11,38 V
In 8	LCD Inverter	0,00 V
In 9	Internal 15V	15,25 V
In 10	CPU Voltage 5V	5,06 V
In 13	Pa Voltage	5,62 V
In 14	PA Current	0,08 A
In 17	Dirver Voltage	2,64 V
In 18	Driver Current	0,13 A
In 19	Temperature	25,43 °C
InD 24	External Interlock	RF On
Out 0	% Power Out	0,4 %

- The "Type" column indicates the type of measurement:

“In” -> analogical input,

“InD” -> digital input,

“Out” -> output.

When you click on any of the measurements, the window of the measurements set-up is displayed (obviously only for "I/O" and "General" measurement types enabled).

To enter a new value, it is necessary to write it in the "Data" box and press enter.

Measure Setting

<i>Type</i>	<i>Name</i>	
Out 0	% Power Out	
<i>Data</i>		<i>Unit</i>
10,0 %		%

Return

5) **The control bar:**

The control bar is composed of 3 parts:

- The control icons:



The password: The first icon represents the password. If this icon is activated in the station a closed lock appears on a yellow background, otherwise it is open as shown on the picture.

When you click on the icon, the window for the password selection is displayed.

The measurement cycle lock: The second icon indicates the status of the interrogation cycle of the modules. When clicking on the icon you obtain a lock of the selected module in the window displaying the summary information concerning the station (1):

It is used when it is necessary to update only a few measurements faster.

When the icon is selected, its background is coloured in red.

The bell: The third icon enables to launch the acoustic indicator in case an alarm is received.

The programation of a station: When the third icon is selected, the remote programation window is displayed in the preset stations.

When the station is preset, it is not necessary to program the data on the SIM card of the GSM modem since they are saved in the unit itself.

Please read Chapter 5: "Programation of the remote station" to know more about this function.

When you select the fifth icon, time and date are displayed.

- The recorder:

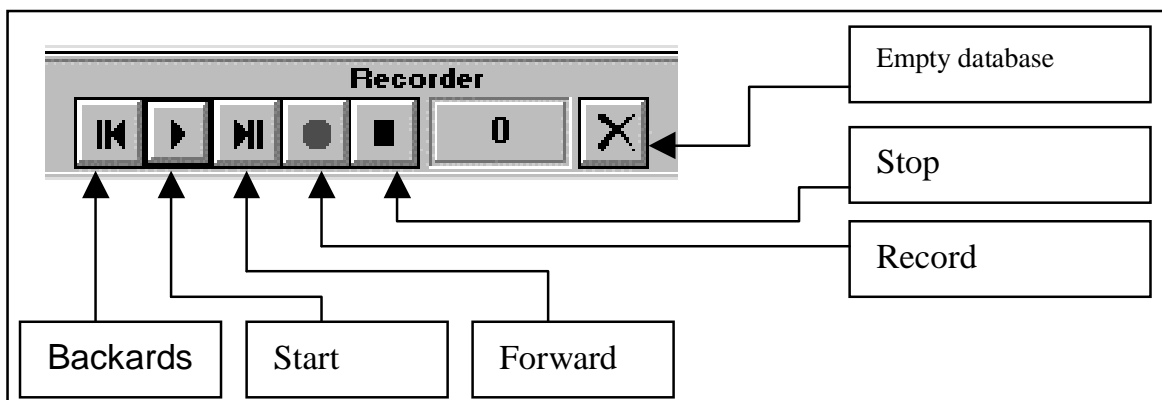

It enables to record in a database all the data received from the station.

Its functioning is similar to this of a normal tape-recorder.

- The communication status icons:

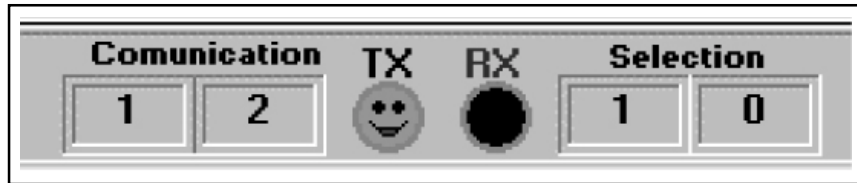

They enable to analyze the status of the serial communication.

On the left, under the word "Comunication", the nod number and the identification number of the interrogated module are displayed.

In the middle, there are two icons that indicate the status of the transmission and serial reception (green=OK, red=No).

On the left, under the word "Selection" the selected node and the module are displayed in the window displaying the summary information concerning the station (1).

1.5 Programation of a remote station



By clicking on this icon the window showing the programation of the remote station is displayed.

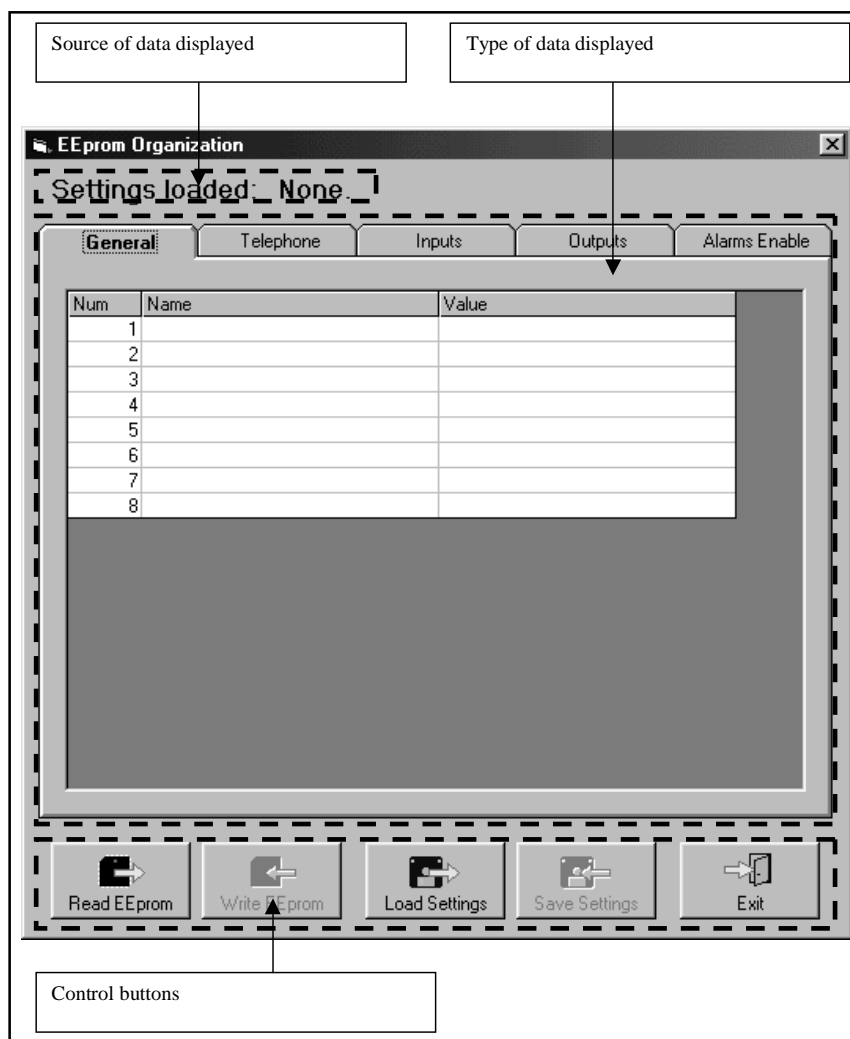

From this window it is possible:

- To read and write the parameters of the remote station,
- Enter and save the parameters in the database of the station itself.

When the window is displayed it does not contain any data, it is necessary to read them from the remote station or from the database.

1.5.1 How to select functions



Press this button in order to read the parameters of the station.



Press this button in order to program the parameters in the station.



Press this button in order to read the parameters from the database of the station.



Press this button in order to write the parameters in the database of the station.

In this way, each station memorized in the Telecon software contains the programmed parameters.

The type of data identify the groups of options that can be programmed:

- 1) General: these are the parameters common to all the types of RVR stations.
 - ID of the station
 - Name of the station
 - Number of the SMS Assistance Center
 - Number of SMS attempts
- 2) Telephone:
 - Phone numbers recognized by the station
 - Enables to send SMS messages to the system
 - Enables the reception of SMS messages.
- 3) Inputs: monitoring of the auxiliary inputs that generate alarms (in the predisposed systems).
 - Name of the alarm (that is transmitted in the message)
 - Intervention threshold of the alarm in percentage (0% = 0VDC, 100% = 5VDC)
 - Alarm activation front (indicates whether the alarm is activated or not in case of supply failure).
- 4) Outputs: monitoring of the outputs (in the predisposed systems)
 - Type of output commutation (status, impulsive ON or impulsive OFF).
- 5) Alarms Enable: (in the preset systems)
 - Enables the standard alarms of the station.

When you click on the parameter that you intend to modify, the data entering window is displayed.

The window is slightly different in function of the type of measurement that is to be modified.

Window for the entering of names and numbers. It is possible to write whatever.

Window for the entering of data. It is necessary to choose between the proposed options.

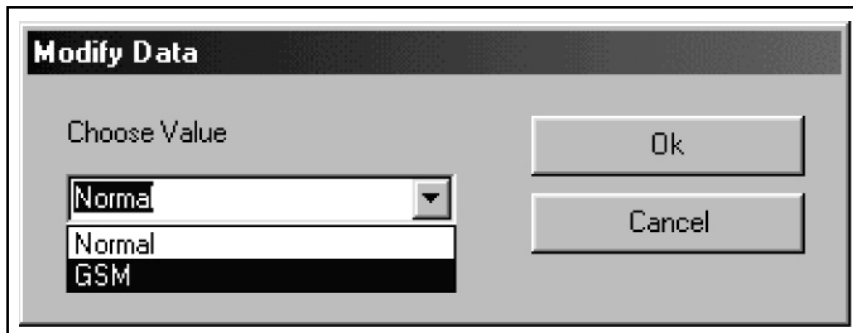

1.6 Structure of the stations.

The Telecon software works exclusively with databases.

Each station present in the Telecon, is composed of several blocks called Modules.

Inside the program folder, there are four folders called: Default, Module, Phbook and Stations, which contain the database of the stations.

Structure of the stations:

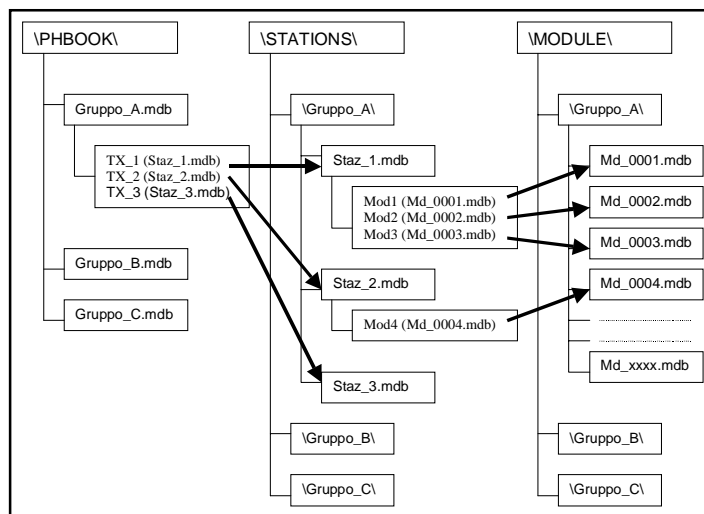

When the program is started the database used situated in the folder \PHBOOK\ is shown, ex. "Group_A.mdb". Each group represents a series of stations.

The database situated in the folder \PHBOOK\ contain the general information concerning the stations: telephone number, connection Baud Rate, COM port used, etc.

Each station included in a "Group_A.mdb" has a connection to a database situated in the folder \STATIONS\Group_A\, which contains the names of the database of the modules that compose it. Such databases are situated in the folder \MODULE\Group_A\ and are copied and renamed when the creation of the station from the folder \DEFAULT\ happens.

Example: Let's imagine a group called "Radio1", which contains one station only called "TX500".

The record of the database "Radio1.mdb" will be composed in the following way:

D	Name	Descriptions	Phone	ModemString	DialString	DBName	Com	Baud	Type	InitString	Protocol
1	TX500	-- None --	01239	ATX3	ATDT	TX500.MDB	1	4	0	9600,n,8,1	PROTOCOL_RVR

The area "DBName" contains the name of the database (TX500.mdb) situated in the folder \STATIONS\Radio1\ which contains the information concerning the composition of the station.

The database of the station, is composed by five tables:

- Alarm

Contains the data concerning the received alarms.

- Alarm_Storic

Not exploited.

- Configuration

Contains the data concerning the composition of the station.

- Measure_Storic

Not exploited.

- Personal_Window

Contains data concerning the personalization window.

Therefore in the "Configuration" table of the database \STATIONS\Radio1\TX500.mdb you will find information concerning the composition of the station.

Structure of the "Configuration" table.

Node	Module	Name	DBName	Module Number	Enabled	Type	Configuration
0	0	Total Node		1	0		
1	0	TLCLCD	MD_0001	3	-1	TLCLCD	>_ _
1	1	PTX30LCD	MD_0002	0	-1	PTX30LCD	>_ _e_
1	2	TLM PJ500	MD_0003	0	-1	TLM2	>_ _._

The area "DBName" contains the name of the databases situated in the \MODULE\Radio1\ folder which contain the information concerning the modules.

1.7 Structure of the database

The TLC300 has one (or two) telemetry cards (8 balanced analogical inputs, 16 analogical/digital inputs and 8 relay outputs) and one I2C.

When seen through the Telecon, each telemetry card present and each unit connected through I2C appear as Modules

There are some acknowledgements to respect:

- 1) The first Module (number 0) ALWAYS contains the unit which is equipped with telemetry.
- 2) Then the units connected through I2C Bus are shown.
- 3) Then the telemetry cards

Let's analyze an example of typical station: TX500 equipped with telemetry (TLC300/T1).

The TX500 is composed of: one PTX30LCD, one PJ500MC and obviously the TLC300.

The station, for the Telecon, will be composed of:

- 0 - TLC300
- 1 - PTX30LCD
- 2 - Telemetry card for PJ500MC

1.7.1 The modules

Each Module has a corresponding database which contains the data concerning the available measurements.

The database, contains seven tables:

- Alarm Name
contains the information concerning the alarms
- Analog Input

contains the data concerning the analogical inputs

- Analog Output

contains the data concerning the analogical outputs

- Digital Input

contains the data concerning the digital inputs

- Digital Output

contains the data concerning the digital outputs

- General

contains the data concerning the general measurements

- Info

contains the information concerning module

N.B. In function of the type of unit that they represent, the tables can also contain data.

Let's Analyze the module related to the standard telemetry card: it contains: 24 analogical inputs (8+16) and 8 relay outputs; therefore data will be found only in the Analog Input and Digital Output tables.

Similarly, for the PTXLCD (which has 39 analogical inputs, 2 analogical outputs, 8 digital inputs, 29 digital outputs, 8 general measurements), data will be found in all the tables.

All the tables (except Info and Alarm Name) have the same structure:

Name of area	Type of data	Description
Key	Numerical	Univocal identification key
ID Measure	Numerical	Identification of the measurement
Display Order	Numerical	Ordering displayed data
Enable Input	Yes/No	Enable input
Enable Display	Yes/No	Enable display
Name	Text	Measurement Name
Measure Unit	Text	Measurement Unit
Conversion Type	Text	Type of conversion
End Scale	Numerical	End scale
Start Scale	Numerical	Start scale
Max	Numerical	Maximum value
Nominal	Numerical	Nominal value
Min	Numerical	Minimum value (offset)
Format	Text	Displaying Format
Input Mask	Text	Input Mask
Resolution ADC	Numerical	Resolution ADC converter
Type	Numerical	Type of measurement
Text for Max	Text	Text to be displayed when maximum value is reached
Text for Min	Text	Text to be displayed when minimum value is reached

For example:

The first analogical input of the telemetry card is composed in the following way:

Key	0	Number of the measurement
ID Measure	0	Position in the order display
Display Order	1	It is possible to enter values (not for the inputs)

Enable Input	Si	It is displayed on the Telecon grids
Enable Display	Si	Name of the measurement
Name	Analogical 1	Name of the measurement
Measure Unit	V	Measure unit, Volt
Conversion Type	TENS/CORR	Conversion for voltage and current measurements
End Scale	5	Value displayed when input at the maximum
Start Scale	0	Value displayed when input at the minimum
Max	6	Value after which the alarm is generated
Nominal	0	Not used parameter
Min	0	Value under which alarm is generated
Format	#0.0	the datum has a number after the comma
Input Mask	###	Not used parameter
Resolution ADC	1024	ADC resolution (useful for calculations)
Type	1	1 = analogical input
Text for Max	???	Text displayed when at the maximum (only digital input)
Text for Min	???	Text displayed when at the minimum (only digital input)

With such settings, the voltage present at the input will be displayed.

1.7.2 How to modify the database

If the user needs to modify the measurements on already existing databases, the parameters to modify are the following:

- Conversion Type
- End Scale
- Max
- Enable Input
- Enable Display

Conversion Type: determines the calculations to make with the received datum.

The different algorithms were created in function of the requirements of the equipment manufactured by R.V.R. and include power measurements, voltage and current, logical status, etc.

End Scale: indicates the maximum value displayed corresponding to the maximum voltage applied at the input.

Max: value indicating the threshold for the generation of a visible alarm on the Telecon grids.

Enable Input: value Yes/No which indicates whether it is possible to set a measurement value.

Ex. When an input is selected it is on "No" because it is not possible to set an input value, while for measurements like i.e. the output power of the PTXLCD, it is on "Yes" because the user can choose the value he wants to enter.

Enable Display: value Yes/No which indicates whether the measurement appears in the Telecon grids has also a consequence in the personalization.

1.8 Creation of groups and stations

In this chapter we will deal both with the creation of a station and with the creation of a group.

1.8.1 How to create a group

From the main window, select the button "New".

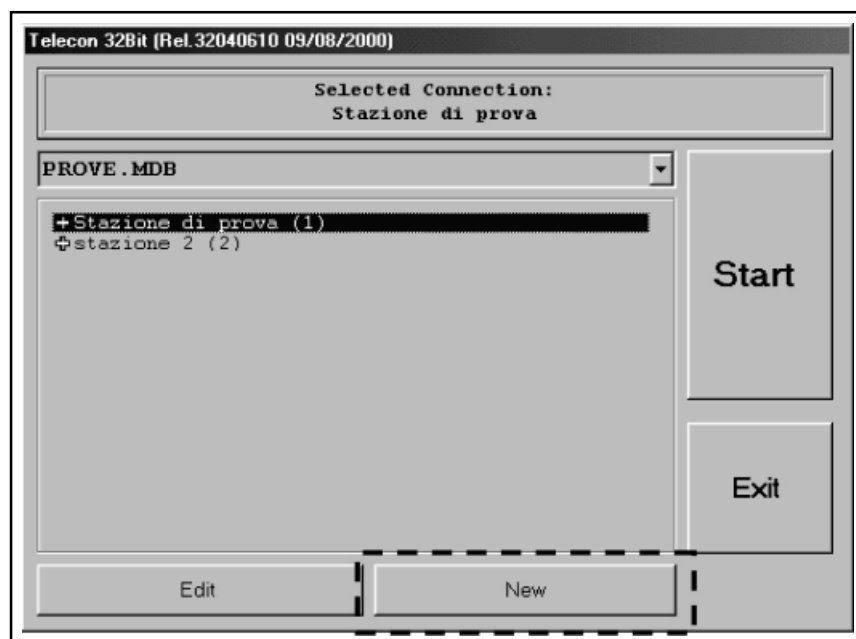

The program will ask you if you want to copy the list of stations which are part of the selected group and then it will ask the name of the new group.

At the end of the creation process, you will obtain a new group with a station called

"Default" in case you have chosen not to copy the list of stations, otherwise you will find the same list of stations that composed the original group.

1.8.2 How to create a station

From the main window, select the "Edit" button.

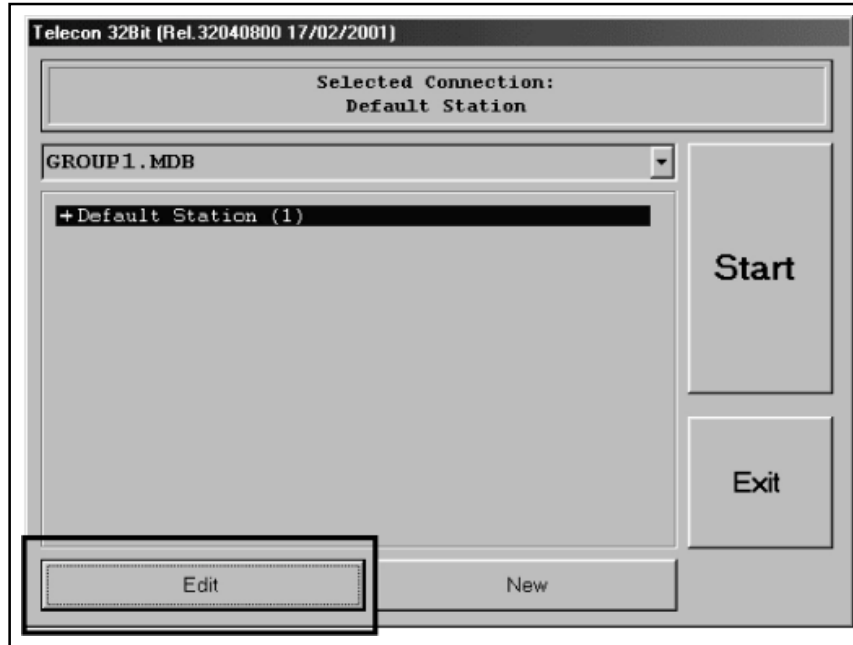

The editing window of the station will be displayed. It is important to mention that the stations are composed of two parts, one is situated in the "Phone book" window where the connection is monitored while another is situated in the structure of the station.

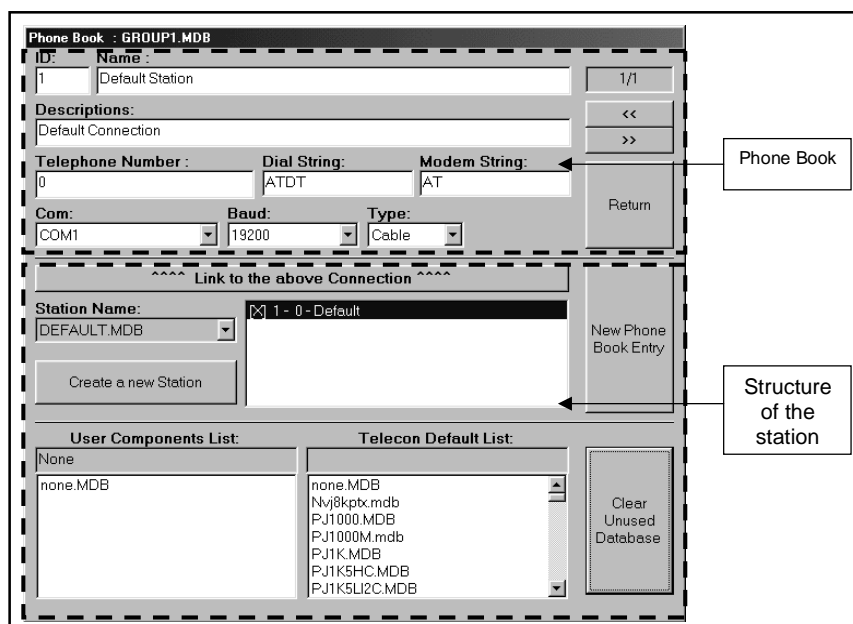

Structure of the station:

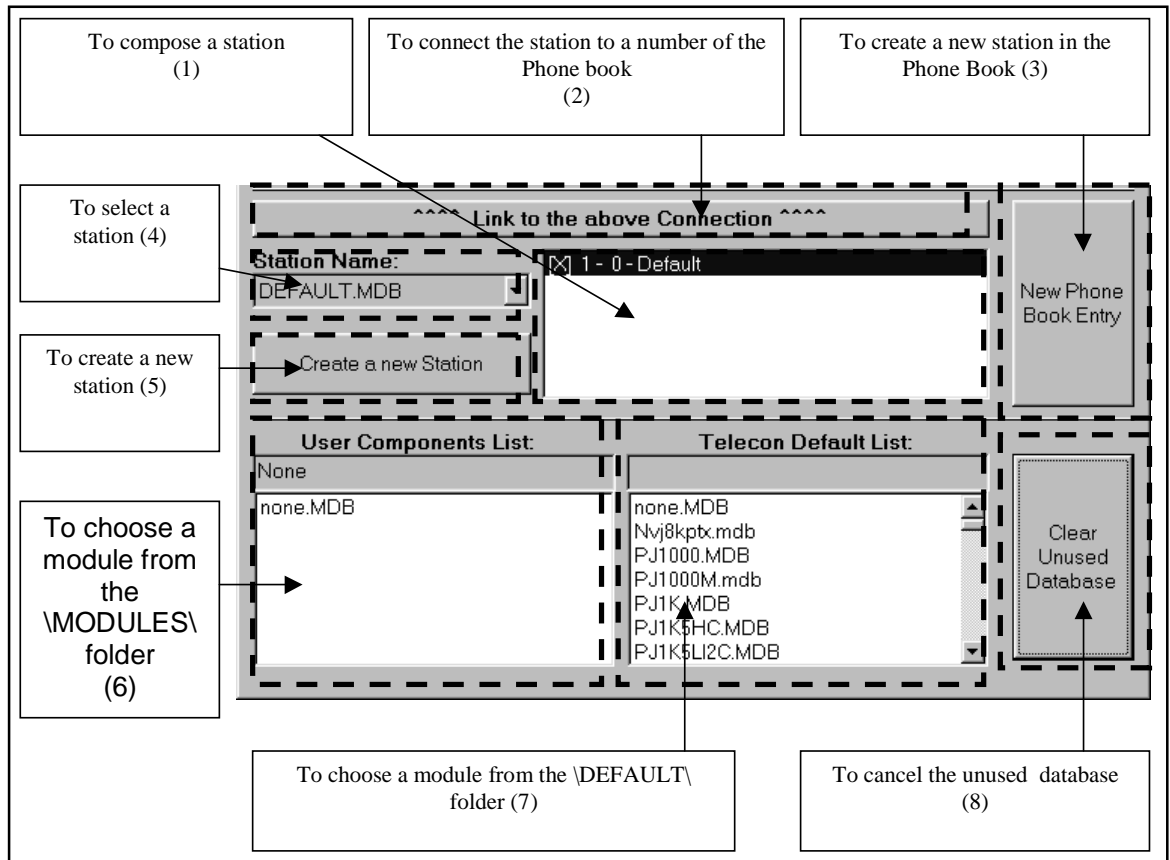

The steps for the creation of a station are the following:

The chosen station is TX500 with telemetry.

As already mentioned in Chapter 7, the station will be composed of three modules,

- 0 - TLC300
- 1 - PTX30LCD
- 2 - Telemetry of the PJ500MC

It is necessary to create a new name in the Phone Book, which can be done by selecting button (3).

- 1) Select button (5): the program will ask you whether you want to copy the station that is currently select, press "no"; enter the name of the new station (Ex.TX500).
- 2) Select the new created station from the menu (4).
- 3) In the window "Station composition " (1), you will find:

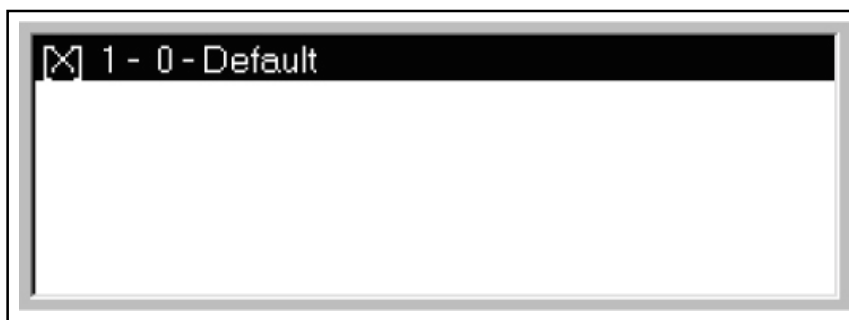

- 4) Search the module "TLC300.mdb" in the list (7)
- 5) Click on the module and keep the left button of your mouse pressed, and drag it into the window (1).

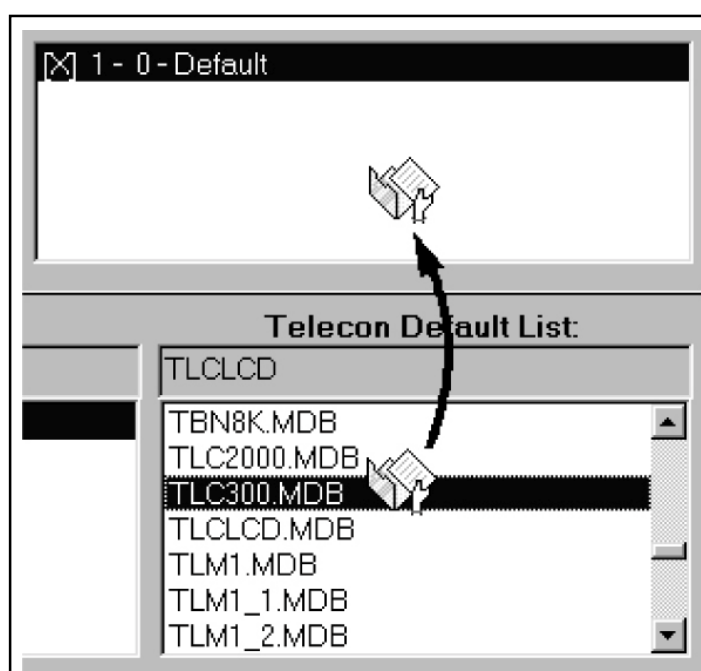

- 6) The program will ask you whether you want to replace the selected module (Default) by the module you have chosen. Select "Yes".

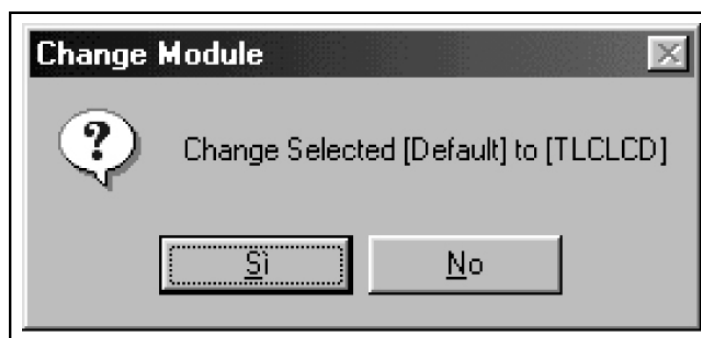

In this way you will replace the "Default" module by "TLCLCD", which are the letters identifying of the TLC300.

- 7) In the window (6) "Md_00001.mdb" is displayed, which is the "TLC300.mdb" database renamed and copied in the folder \MODULE\Group1\.
- 8) Search the module "PTX30LCD.mdb" in the list (7).
- 9) Click on the module and keep the left button of your mouse pressed, and drag it into the window (1)

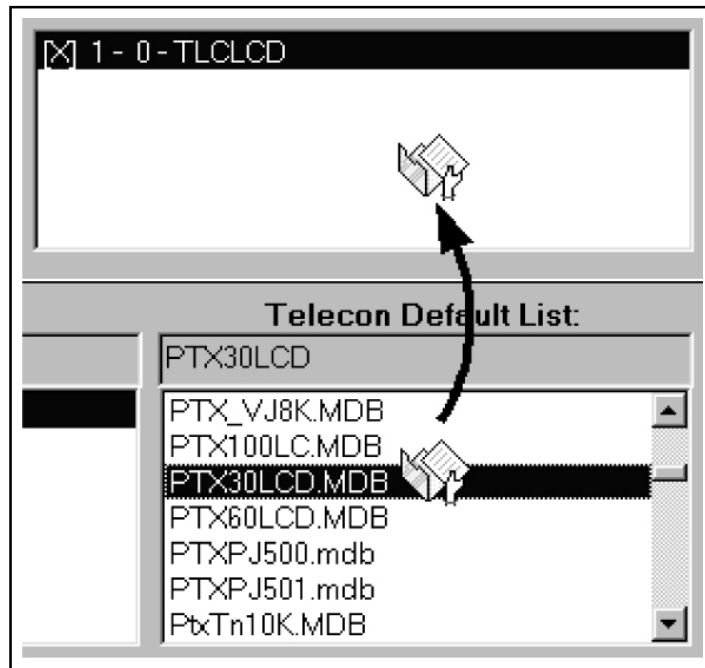

- 10) The program will ask you whether you want to replace the selected module (TLCLCD) by the module you have chosen. Select "No".

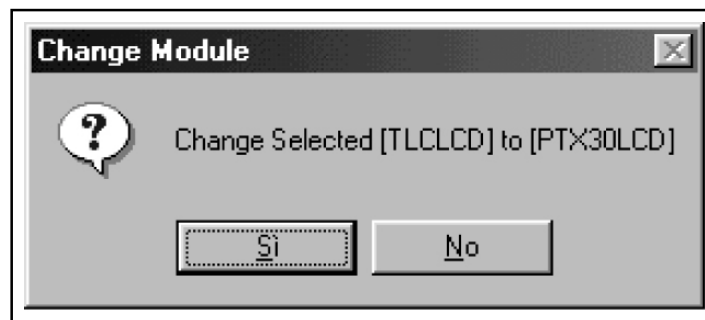

The program will ask you whether you want to add (append) the module to the configuration of the station. Select "Yes". If you choose "No" the module will not be added to the station. The program will ask you to confirm the node and module numbers, the program automatically chooses the values so they should not be changed.

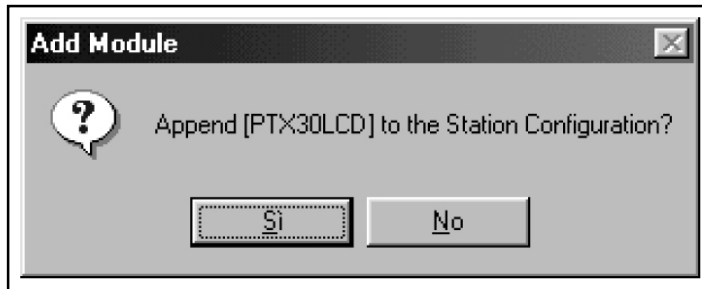

In the window (6) "Md_00002.mdb" is displayed, which is the "PTX30LCD.mdb" database renamed and copied in the \MODULE\Group1\ folder.

- 11) Search the module "PJ500.mdb" in the list (7).
- 12) Repeat 8 and 9. You should obtain the situation shown in Figure:

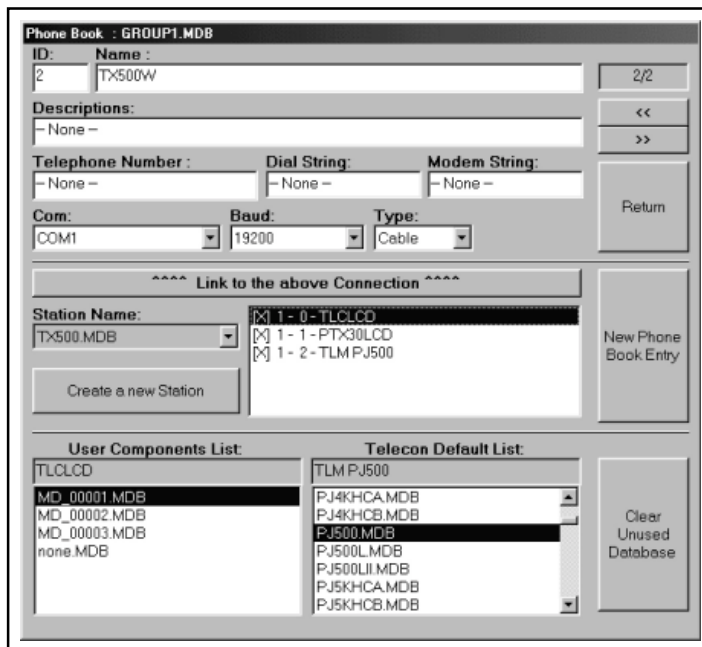

- 13) The structure of the station is completed, so it is now necessary to connect it to a number from the Phone book. In order to do so, press button (2).
The guided creation of a station is completed.

1.9 Creation and editing of the Personalization window

1.9.1 Preliminary acknowledgements

In this chapter we will analyze the creation of a personalization, starting from an empty window.

Press the "Detail" button to enter the Personalization window





Click on button "F4" situated on the window to enter the "edit" mode, the shape of the mouse cursor will change  .

Click with the right button of your mouse to enter the menu with three options:

- Add Control.

To add a control

- View Grid.

To switch on or off the display of the grid

- Save Window.

To save the personalization window.

N.B. We advise you to use this function very often in order to avoid loosing the realized work

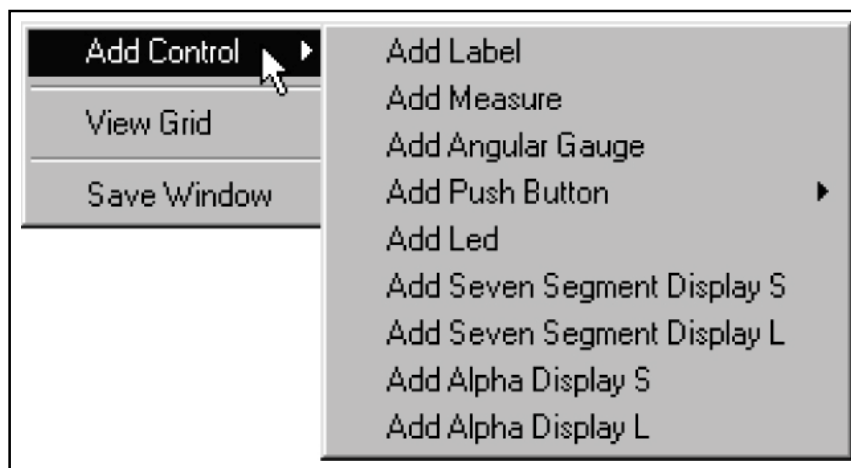

The "Add Control" menu contains the submenus from where you can choose the items that can be added in the window:

- Add Label.

Frequency

To add a label.

- Add Measure.

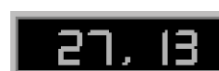

To add a numerical measurement (the use of the "Alpha Display") control is anyway advised

- Add Angular Gauge.

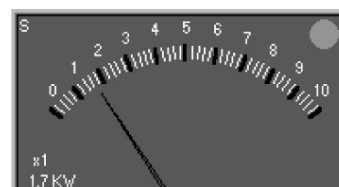

To add an analogical instrument.

- Add Pushbutton.

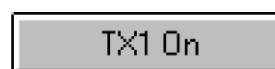

To add a button in order to send commands.

- Add Led.



To add a signalisation led.

- Add Seven Segment Display (S o L).

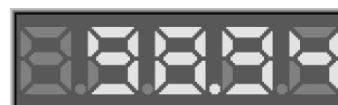

To add a LCD type display for numerical measurements

- Add Alpha Display (S o L).



To add an alphanumeric display, which may be used

1.9.2 Guided creation of a personalization

In this brief instruction chapter, we will explain the operations which are necessary in order to create a personalization window.

La station used as a reference will be a TX500 (TLC300, PTXLCD, PJ500MC)

In order to add an instrument to indicate the output forward power.

- 1) Press F4 in order to enable the EDIT mode
- 2) Click with the right button of your mouse on the area where you want to add the command.
- 3) Select "Add Angular Gauge" from the "Add Control" menu
- 4) The selection window will be displayed

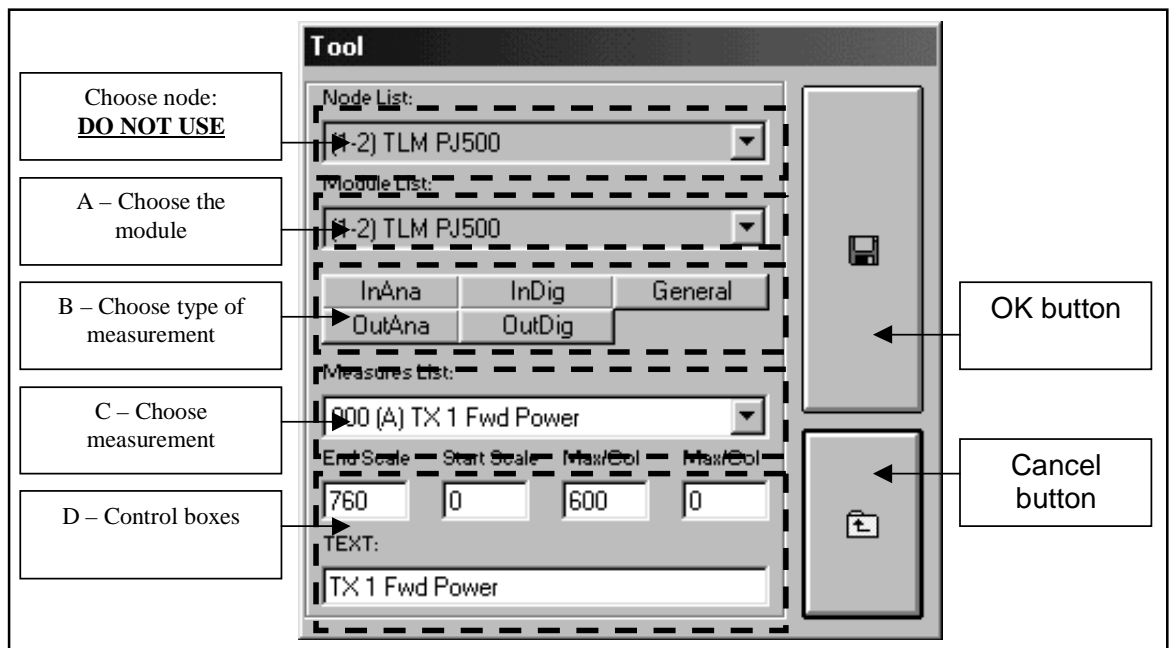

In the box "A" choose the module "1-2" which corresponds to the PJ500.

- 5) Choose between the "B" buttons, on "InAna" in order to have the list of analogical measurements displayed.
- 6) In the "C" box select the "Fwd Power" measurement.
 "000 (A) TX1 Fwd Power" means: "000" which is the input number, "(A)" indicates that the input is analogical, the remaining is the name of the input (which is the same as box "Text:" from the group "D").
- 7) These options are valid only for the "Angular Gauge" control: boxes from group "D".

If you wish to replace the end scale of the analogical meter, write the required value in the "End scale" box.

If you require a maximum value inside the scale (in order to have an alarm led on the command, when the value is superior), write it in the "Max/Col" box.

Ex: If you enter 760 as an "End scale" value and 600 as a "Max/Col" value, you will have a command as shown in the figure. Please note that when the value setted in "Max/Col" is exceeded, the green led situated on the upper and right side becomes red.

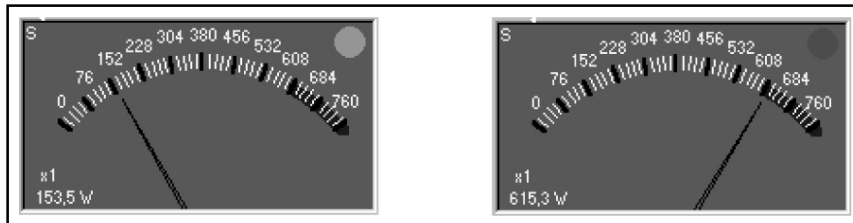

8) Press the "OK" button.

The new command was positioned. It is now possible to have it moved, redimensioned or cancelled.

Please note that when the mouse cursor passes on the control, the icon  changes. In order to move, cancel or vary the dimensions or change the parameters of the command, press the right button of your mouse. The menu from which it is possible to make choices will be displayed.

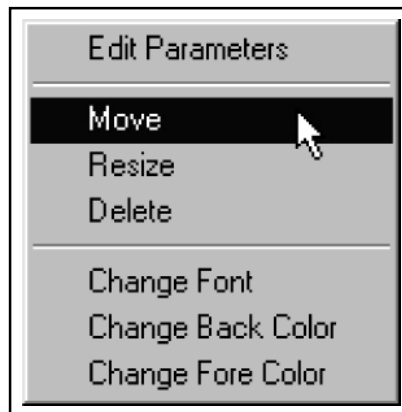

"Change Font" "Change Back color" and "Change Fore Color", are used for the labels (label).

To insert a label (label) in order to recognize the measurement.

- 1) Choose "Add Label" from the "Add control" menu.
- 2) Select the same measurement chosen formerly: PJ500 FWD Power.
- 3) 3. Press the "Ok button".

The result will be as follows:

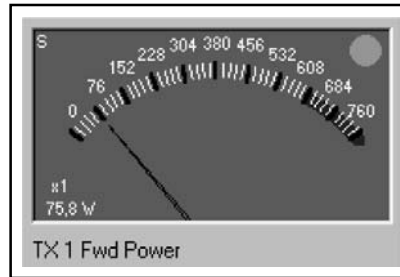

How to insert a led to indicate the presence of an SWR alarm.

- 1) From the menu "Add Control" select "Add Led".
- 2) 2. Select the module PJ500 in box "A".
- 3) 3. Among the "B" buttons, click on "InAna".
- 4) In box "C" choose the measurement "011 (D) TX1 SWR". Make sure the type of input selected is (D) which means it is digital.

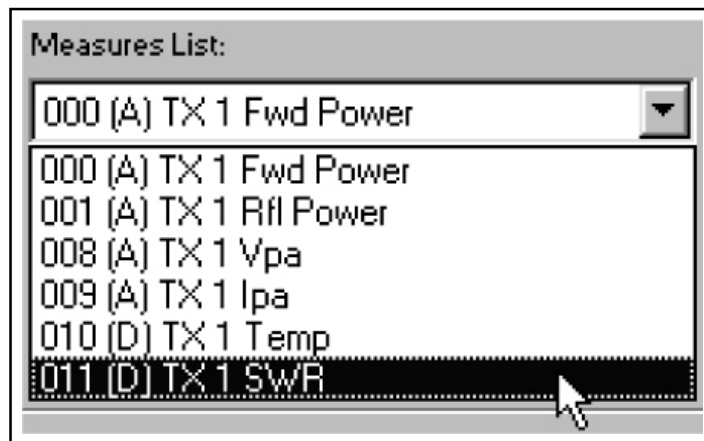

5) It is now possible to select the colour of the led in function of the status of the input:

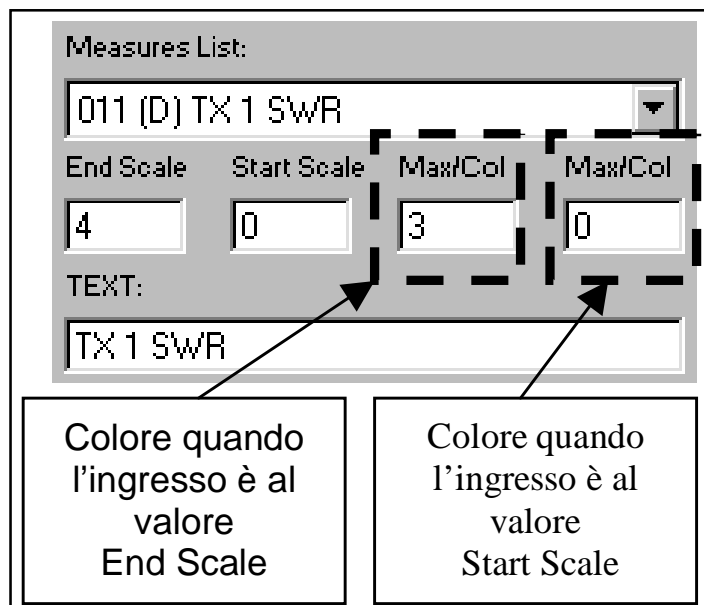

The available colours are five:

- 0 - Black.
 - 1 - Red.
 - 2 - Yellow.
 - 3 - Green.
 - 4 - Blue.
- 6) Press the "Ok" button.
 - 7) If necessary, position the led in the place required.
 - 8) Repeat the same procedure in order to insert a label with the name of the alarm.

We will now create two buttons to switch on and off the transmitter.

- 1) In the "Add Control" menu select "Add Pushbutton "On Type".
- 2) Scegliere il modulo PJ500 dalla casella "A"
- 3) Among "B" buttons select "OutDig".
- 4) In box "C" select the measurement "000 (>) TX1 On".
- 5) In the "Text:" box, enter the name that will be displayed on the button.

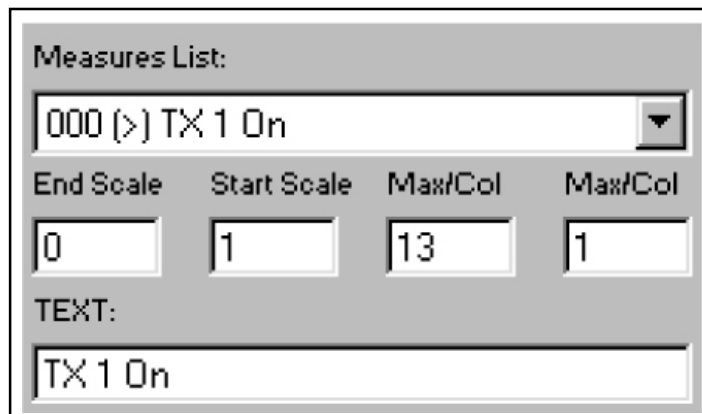

Measures List:			
000 (>) TX 1 On			
End Scale	Start Scale	Max/Col	Max/Col
0	1	13	1
TEXT:			
TX 1 On			

- 6) Press the "Ok" button.
- 7) If necessary, re-position or change the dimensions of the button.
- 8) In the "Add Control" menu select "Add Push button "Off Type"
- 9) Among "B" buttons select "OutDig".
- 10) In the box "C" select the measurement "001 (>) TX1 Off"
- 11) In the "Text:" box, enter the name that will be displayed on the button.
- 12) Press the "Ok" button.
- 13) If necessary re-position or change the dimension of the button.

The personalization should be as follows:

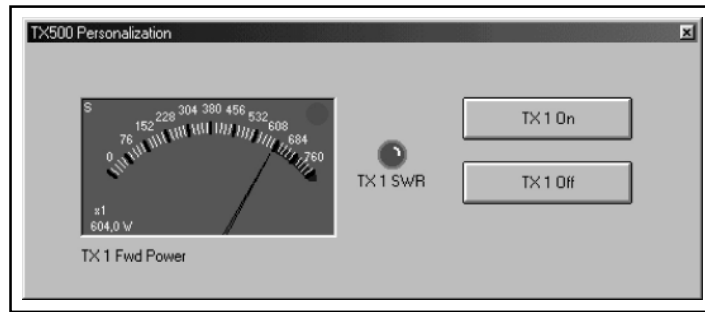

Now you just have to save the window by clicking on the right button of your mouse and choosing "Save Window".

This page was intentionally left blank

2. Monitoring Telemetry Stations

2.1 Functioning

This is a telemetry software that gives the possibility to call automatically and cyclically every station from a list of stations, having their status displayed in a very simple and clear way and indicating which station is in alarm and the type of alarm.

Moreover, it is possible to have the software calling a station after having been informed by an SMS, and have its status displayed immediately.

2.2 Installation

- Insert the CD-ROM in the CD-ROM player.
- From the desktop, open "Program Manager".
- Double click on the CD-ROM player to visualize its content.
- Double click on the program Tlc32bit.exe in order to set up the installation.

It may be required to install the drivers which are necessary for the access to data, before installing the software.

- When the installation is completed, the "Tlc32bit" group which contains the programs: "Telecon 32bit" and "GSM Init" will be created, after which the connection icons will appear on the Desktop.

Required systems:

- Operational system:
Windows 95 ®, Windows 98 ® either first or second edition, Windows ME ®.
The software does not work under Windows NT ® and Windows 2000 ®.
- Processor:
Intel Pentium ® 75 MHz or better.
- Minimum Memory required:
32MB Ram.
- Minimum capacity on Hard Disk required:
Minimo 50Mb.

2.3 Telemetry software

As you can see on the image, the telemetry software is composed of three main windows:

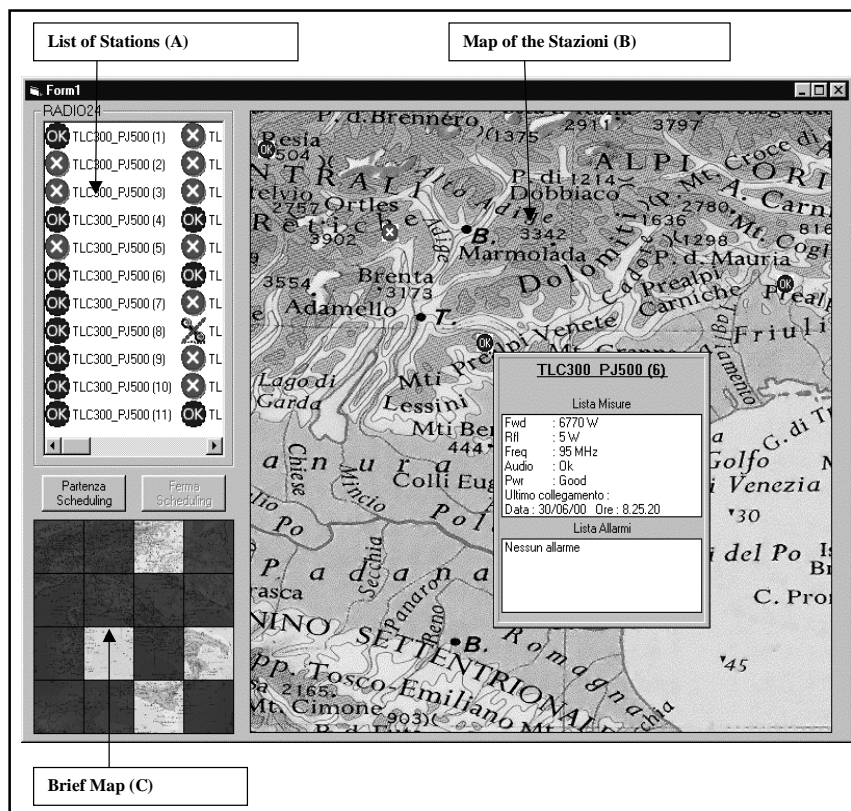

2.3.1 List of Stations (A).

In this list all the stations that concern a customer are displayed.

They are sorted in the following way: presence on the map, priority, frequency of calls and station number in the database.

When positioning your mouse on a station, it is automatically centered in the map (B), and the station will start flashing.

2.3.2 Map of the stations (B).

The position of the stations and their status are displayed. Such map must be built by the user simply by dragging the required stations (taken from the list of stations (A)) to their locations on the map. Once the station is positioned, the schedule monitoring window is displayed. The station will have a different icon in function of the alarms status.

When positioning the cursor on one of these icons a window displays the last parameters and alarms registered, if received.



When clicking with the right button of your mouse on the icon indicated above, a cascade menu will display the following functions:

When selecting " Call Station " the immediate call will be made and the consequent data will be updated.



When selecting "Reset Station" you can make an attempt to reset the functioning conditions in case of alarm.



When choosing "Telecon" you can call the station with the normal telemetry software in order to get more detailed information (for expert users).



When choosing " Properties" a sub-menu with 2 possible choices is displayed:

" Scheduling Manager" which displays a window for the setting of scheduling parameters and priority calls. Such priority will also be used put the stations in order in the list (A);

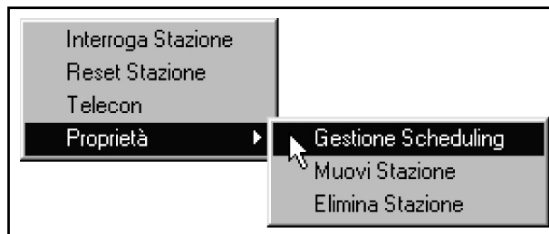

"Move Station" is used to re-position the station on the map.

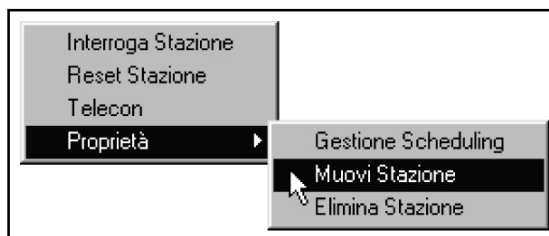

"Cancel Station" is used to cancel the station from the map (but not from the database).

When moving the mouse having the left button pressed, you can scroll the geographic map.

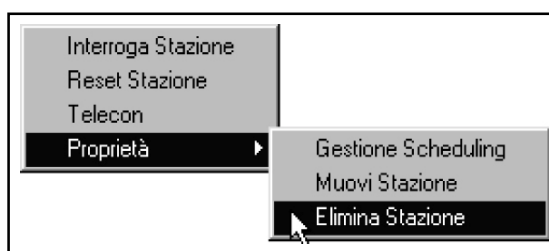

2.3.3 Brief Map (C).

Such map is a reference for the Stations location (B). Basically, it is the same map, but reduced and divided into 16 quadrants. Such quadrants enable a selection of only the required part of the country, since it is impossible to show the whole map in a defined way. Apart from that, in case of alarm the quadrant where the station is situated will be coloured in red to indicate an anomalous situation. In this way it is possible to keep under control the status of all the stations without needing to move the mouse.

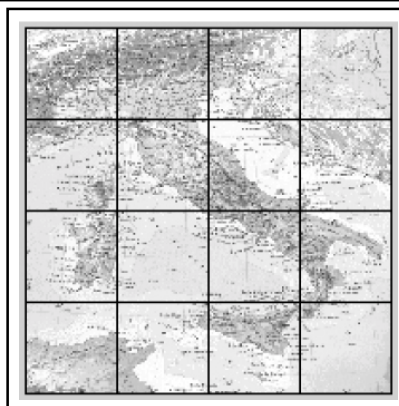

2.4 Scheduling functions

The Scheduling is structured in the following way:



Gestione Scheduling
TLC300_PJ500 (1)

Priorità: (Min Med Max)

N° tentativi: 2 Illimitato

Inizio Scheduling:

Conferma Annulla

- 1) The parameters that can be modified in the station are:
 - Frequency of the calls, being possible to choose among the following values:
 - 1 - 3 times a day (morning, afternoon and evening)
 - 2 - once a day, morning
 - 3 - once a day, afternoon
 - 4 - once a day, evening
 - 5 - 3 times a week
 - 6 - once a week
 - 6 - once a month
 - 8 - Never

- Priority. The priority will be selected through a slider having three positions (high, medium, low) that the customer may use to set the order in which calls should be made. Basically, if some stations are more important than others, it will be necessary to assign to this station a priority higher than the priority of other stations. When the system starts making the calls, it will first call the higher priority stations, then medium and so on... This choice in priorities also influences the order in which the stations are displayed in the List (A).
- Number of attempts. It is possible to set a number of attempts "retry" from 1 to 99 + ∞ which represent the number of attempts that the program must make before the station is considered as disconnected, therefore before communication alarms are released. If you choose ∞ the software will try to make the connection until he succeeds to.

All the other call parameters, telephone number etc., are copied from the Telecon database.





The stations are put in order in the list (A) for:

- Presence on the map,
 - priority
 - frequency of calls,
 - identification number in the Telecon database
- 2) The two buttons: "Start Scheduling" and "Stop Scheduling" are used to start or to interrupt the automatic procedure of calls. In this way if the user wants to call a station manually (while the cycle is started), he will have to set the software on "Stop Scheduling", then wait that the actual call is completed (if there is a call being made) and therefore he will be able to make the call by selecting the proper icon with the mouse on the cascade menu. It would be appropriate to insert a password for the selection from automatic to manual mode so that only the specialized technician has access to such operation. Anyway the software should always start in Automatic mode.
 - 3) In automatic mode the software starts from the first station of the List (A), and so on until the last one (N.B. ONLY the stations that are present on the map are called). Once the list is finished, and in function of the number of retries setted, the system calls the stations that did not respond the first time. The software will go on until a response from all the stations is obtained and until there are no retries available.



In case the call cycle is completed before the change of call cycle, the program remains in stand-by; the "Start Scheduling" button changes to "Call Stations".

In this way it is possible to have the program making an additional cycle of calls to all the stations without taking into account the last call and without exiting the scheduling cycle.
 - 4) The following 4 symbols indicate the status of the stations:

Where these icons appear:

-  indicates that the station is working correctly.
-  indicates that the station is in alarm.
-  indicates that the maximum number of retries was reached.
-  indicates that the program is making a retry.

There are also three other symbols used in the list (A):

-  indicates that the station is being called (used only in scheduling).
-  indicates that the station has not already been called (used only in scheduling)
-  indicates that the station is not present in the map.

Apart from the normal parameters displayed (Power, frequency etc.) there will also be the time and date of the last connection.

- 5) 5. When the scheduling cycle is operational, the following functions are not available:
- dragging of stations to the map
 - positioning of the stations from the list (A) to the map
 - - the menu selected with the right button of the mouse is not available, except the scheduling configuration window that can be seen but not modified.

2.5 Technical information concerning the realization

For the realization of this software we have used the telemetry software (TELECON) with an additional new window..

The basic communication structure of the software remains the same and all the functions of Telecon remain unchanged. Except this new window and the database of the customer filled with the data present in the Telecon PHBOOK directory.

In such database the user may add new areas and tables in function of the following criteria:

- A. Five new areas were added to the Phone_Book table of the database:
- 1) Presence of the station on the map and therefore also the presence of the scheduling automatic procedure.
 - 2) Name of the table where the registered data and scheduling parameters are entered.
 - 3) Priority number of such station.

The area 3 will be used in order to define the position of a given station in the list (A) and therefore the order for the automatic calls.

4) Frequency of station calls according to the scheme:

0 - 3 times a day (morning, afternoon and evening)

1 - once a day, morning

2 - once a day, afternoon.

3 - once a day, evening.

4 - 3 times a week

5 - once a week.

6 - once a month.

7 - Never.

5) Date of the beginning of the scheduling

B. Configuration tables of the stations. Basically for each station present in the Table Phone_Book, there will be 2 corresponding tables having a name with progressive initials that will refer to the station situated in the area formerly described. The name of the two stations will start with a different suffix in order to identify them:

"_sto" for the table where the data received by the remote station are stored,

"_cfg" for the table where the scheduling configuration data are registered.

The following areas are present in these tables:

Table "_cfg"

1) Position X on the map. (Single)

2) Position Y on the map. (Single)

3) Data Start Scheduling

4) Start Time of Scheduling

5) Number of Retry from 1 to 99, with 0 indicating "unlimited"

6) Date of the last connection

7) Time of the last connection

8) Status of the station during the last connection:

0 - OK - Station functioning correctly.

1 - COM - Communication problem (when maximum number of retry is reached)

2 - RETRY - Station making a Retry.

3 - FAULT - Station in Alarm.

Table "_sto"

1) String received with data.

- 2) String received with alarms.
- 3) Byte indicating the number of alarms present.
- 4) Date of the last connection.
- 5) Time of the last connection.
- 6) Status of the station at the last connection (see point 8)

Each station present in the Phone_Book table will have a corresponding configuration table as shown in point B.

Each time the software will restart these data will be loaded and displayed.

This page was intentionally left blank

3. Interconnection example (TLC)

3.1 In Digital with RVR's LCD Equipment

In the case of connection between the TLC system and digital equipment exclusively using the digital input on bus Ilc must respect some sagacities:

- PTX-LCD excitors serie must have always the lower addresses.
- The coupler HC-LCD serie, in order of addresses after the excitors, must have Type = 133.
- The amplifiers will follow all then.

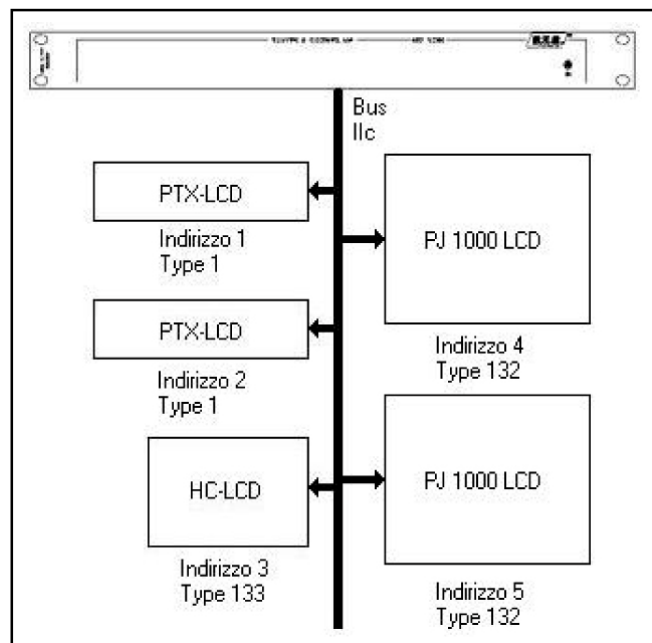

The Type that identified the digital cards are described in the following table:

Type	Nome
0	None
1	PTX30LCD
2	SCM4
3	TLC300/2000
4	SCM1
5	PTX60LCD
6	PTX100LCD
7	TLC tube
8	PTRL NV
9	RXRL NV
129	Telemetry card type 1
130	Telemetry card type 2
131	Telemetry card type 3
132	Mosfet Protection
133	Hc Primary
134	Hc Simple

3.2 In Analogic with RVR's LCD Equipment

To connect different RVR' base equipment between they, that aren't digital, is necessarily use an IB (see accessories), that allows the redistribution of the signals them coming from the equipment in order to make them to reach in right way on the inputs of the TLC.

All the connections between the devices come made through standard parallels cables, connecting between the IB and the equipment the outputs that have the same label:

- Service -> Service
- Telemetry -> Telemetry

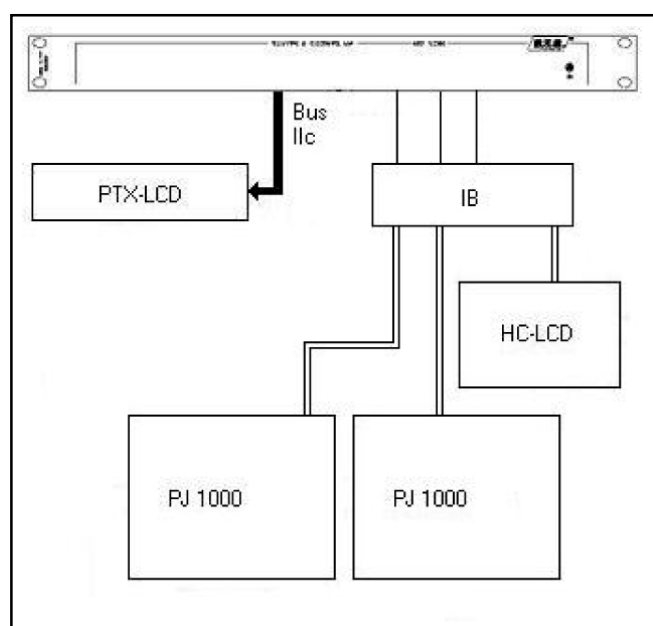

3.3 In Analogic with Generic Equipment

In this case it must resort to the connection tables, remembering that the balanced inputs are operative with not greater tensions of 12V while those digitals arrive to the maximum to 5V.

The tensions must be in continuum current.

3.3.1 How to control a D.C.voltage superior to 5V

Connect to DB25 marked as BALANCED ANALOG INPUT on the PIN described in the table

Pin number	Meant	Adj. Trimmer
2 (+), 14 (-)	Analogic balanced input n°1	RV1
3 (+), 16 (-)	Analogic balanced input n°2	RV2
5 (+), 17 (-)	Analogic balanced input n°3	RV3
6 (+), 19 (-)	Analogic balanced input n°4	RV4
8 (+), 20 (-)	Analogic balanced input n°5	RV5
9 (+), 22 (-)	Analogic balanced input n°6	RV6
11 (+), 23 (-)	Analogic balanced input n°7	RV7
12 (+), 25 (-)	Analogic balanced input n°8	RV8
1, 4, 7, 10, 13, 15, 18, 21, 24	Massa	

Obtain the maximum of the voltage and regulate the correspondent trimmer in order to obtain the visualization, on the remote control software, the voltage of 5V. See the software manual to set up correctly the database necessary to have an immediate visualization of the parameter in the right unit of measure.

3.3.2 How to control a voltage inferior to 5V

Connect to DB25 marked as DIGITAL/ANALOG INPUT on the PIN described in the table:

Pin number	Meant	Jumper su JP4
2	Digital/analogic unbalanced input n°1	pos. 1
15	Digital/analogic unbalanced input n°2	pos. 2
3	Digital/analogic unbalanced input n°3	pos. 3
16	Digital/analogic unbalanced input n°4	pos. 4
4	Digital/analogic unbalanced input n°5	pos. 5
17	Digital/analogic unbalanced input n°6	pos. 6
5	Digital/analogic unbalanced input n°7	pos. 7
18	Digital/analogic unbalanced input n°8	pos. 8
21	Digital/analogic unbalanced input n°9	pos. 9
9	Digital/analogic unbalanced input n°10	pos. 10
22	Digital/analogic unbalanced input n°11	pos. 11
10	Digital/analogic unbalanced input n°12	pos. 12
23	Digital/analogic unbalanced input n°13	pos. 13
11	Digital/analogic unbalanced input n°14	pos. 14
24	Digital/analogic unbalanced input n°15	pos. 15
12	Digital/analogic unbalanced input n°16	pos. 16
1, 6, 7, 8, 13, 14, 19, 20, 25	GND	

Obtain the visualization, on the remote control software, of the parameter. See the software manual to set up correctly the database necessary to have an immediate visualization of the parameter in the right unit of measure.

3.3.3 How use the relay outputs

Remembering that in figure is represented schematically the Off relay condition and that the disposition of the contacts in the connector is described in the following table.

Pin number	Meant
1 (C), 14 (NC), 2 (NO)	Relay n°1
15 (C), 3 (NC), 16 (NO)	Relay n°2
4 (C), 17 (NC), 5 (NO)	Relay n°3
18 (C), 6 (NC), 19 (NO)	Relay n°4
7 (C), 20 (NC), 8 (NO)	Relay n°5
21 (C), 9 (NC), 22 (NO)	Relay n°6
10 (C), 23 (NC), 11 (NO)	Relay n°7
24 (C), 12 (NC), 25 (NO)	Relay n°8
13	GND

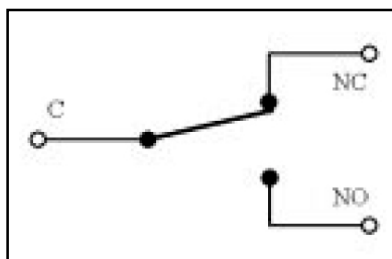

The maximum current that could be made flow through the contacts is of 500mA to 24V.

See the manual of the software to move the relay and set up the necessary database correctly to have the operationing of the relay adjusted to the demands.

4. Commands from remote (TLC)

Through these commands sends under form of SMS they could be modified the states of any exits and activate any functions of the TLC.

- INFO: Sending this message as SMS from any mobile phone, you must have in answered an other SMS with the number and name of the station, the forward and reflected power present in percentage and the currents alarms.
- ALARM: Sending this message as SMS from any mobile phone, you must have in answered an other SMS with the number and name of the station, the forward and reflected power present in percentage, name and number of the last 6 alarms currently in memory.
- TXON: Sending this message as SMS from any mobile phone, it moves the relay 1 of the base telemetry card n.1 in TOGGLE_OFF modality and you must have in answered an other SMS message with the number, name of the station and the wording " Comand SMS Ok".
- TXOFF: Sending this message as SMS from any mobile phone, it moves the relay 2 of the base telemetry card n.1 in TOGGLE_OFF modality and you must have in answered an other SMS message with the number, name of the station and the wording " Comand SMS Ok".
- OUTON (out): Sending this message as SMS from any mobile phone, it moves the relay "num", in the programmed formality, of the last telemetry card and you must have in answered an other SMS message with number, name of the station and the wording "Comand SMS Ok".
- OUTOFF (out): Sending this message as SMS from any mobile phone, it moves the relay "num", in the programmed formality, of the last telemetry card and you must have in answered an other SMS message with number, name of the station and the wording "Comand SMS Ok".
- RESET: Sending this message as SMS from any mobile phone, it reset the present alarms in memory and and you must have in answered an other SMS message with number, name of the station and the wording " Comand SMS Ok".

This page was intentionally left blank

5. Messages on the Modem State (only TLC2000)

In this section is described the visualization of the messages state on the display regarding the modem.

These messages could be in the angle aloft to the right of the display, on the frontal panel (only of TLC2000) and they inform on the modem current state.

These messages could be:

- **Init:** Questo messaggio informa che il modem deve ancora essere inizializzato e quindi la procedura di inizializzazione e' ancora in corso.
- **StdBy:** Il modem e' inizializzato ed in attesa di comandi come si può vedere anche dall'apposito LED posto sempre sul pannello frontale.
- **wait:** Questo messaggio informa che il modem sta tentando di eseguire un'operazione di invio messaggio o di connessine con altro modem.
- **NoDia:** Questo messaggio informa che il modem in seguito ad una richiesta di operazione non riesce a comunicare.
- **Init:** This message informs that the modem owes still have initialized and therefore the procedure of initialization is still in course.
- **StdBy:** The modem is inizialized and waiting to orders like it could also be seen from the set relative LED always on the frontal panel.
- **Wait:** This message informs that the modem is trying to perform an operation of dispatch message or of connection with other modem.
- **NoDia:** This message informs that the modem in succession to an application of operation is not able to communicate.
- **?Busy:** This message informs that the modem is busy and it is ignoring the order that comes him given.
- **OkCon:** This message informs that the modem communicates with the outside and is sending a message in SMS or normal form.
- **Send>:** This message informs that the modem the is about to send message.
- **Ok!:** This message informs that the modem has sent the SMS with success.
- **Hang:** (only PSTN) This message informs that the modem is effecting the procedure of Hang up and therefore it is interrupting the communication.

This page was intentionally left blank

Appendix B Piani di montaggio, schemi elettrici, liste componenti / *Component layouts, schematics, bills of material*

Questa parte del manuale contiene i dettagli tecnici riguardanti la costruzione delle singole schede componenti il SCM1+1. L'appendice è composta dalle seguenti sezioni:

This part of the manual contains the technical details about the different boards of the SCM1+1. This appendix is composed of the following sections:

Description	RVR Code	Vers.	
	Pages		
CPU section	CSPTCPU55202	1.1	4
Power supply	CSSWPSUP0003	1.0	4
Main card TLC SCM	CSTLSCCPU002	1.1	4
Scheda telemetria base 24 input / 8 Relays	CSTLMINP1-01	1.0	4
Scheda TLC (Analogica bilanciata)	CSTLMANABI01	1.0	4
Scheda scambiatore 4-1 con comando coassiali	CSTLMSC41-01	1.0	4
Scheda filtro connettore DB9	CSDB9MFILFL2	1.0	4

Pagina lasciata intenzionalmente in bianco
This page intentionally left blank

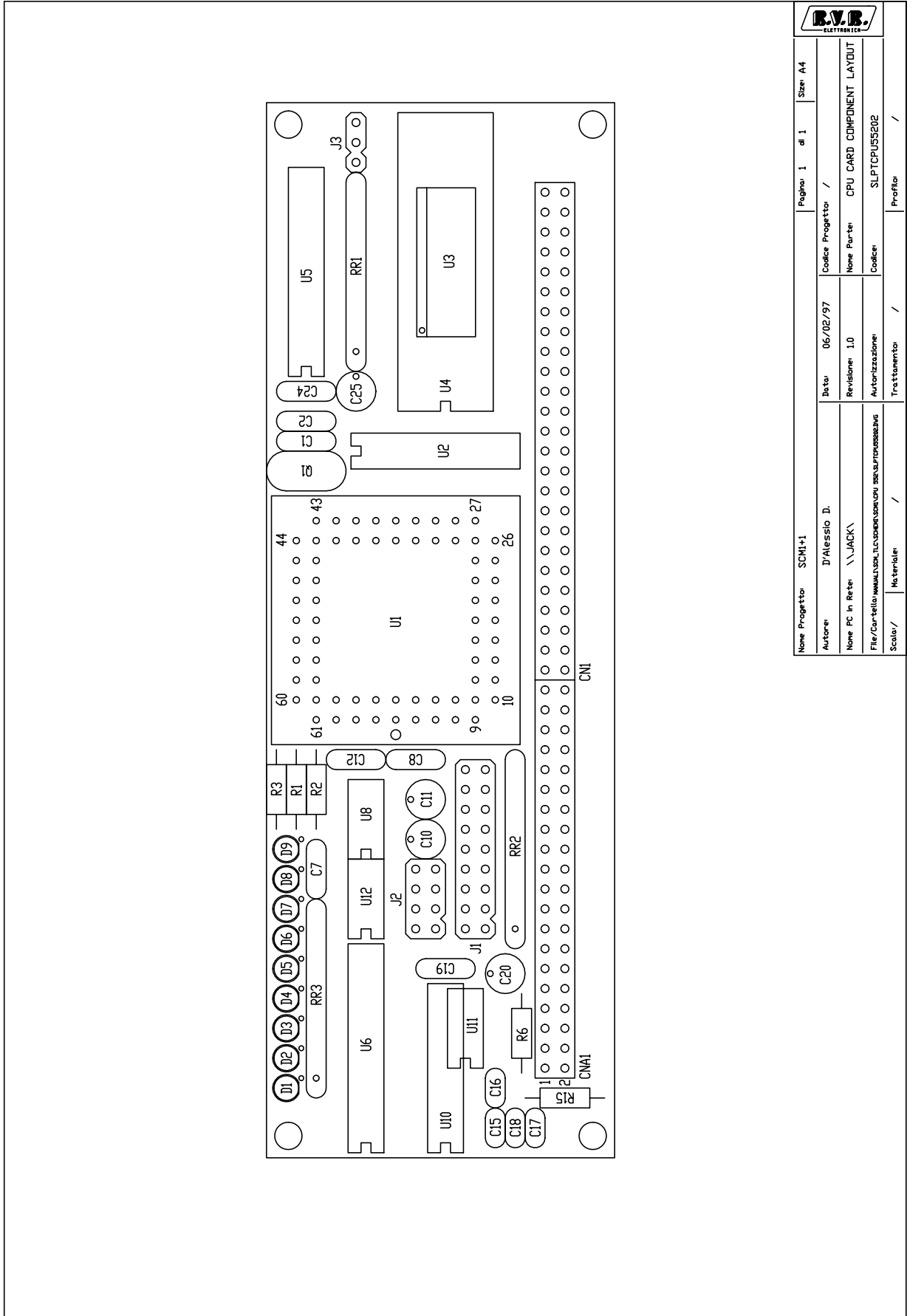

Nome Progetto: SCM1+1		Pagina: 1 di 1		Size: A4	
Autore:	D'Alessio D.	Data:	06/02/97	Codice Progetto:	/
Nome PC in Rete:	\\JACK\	Revisione:	1.0	Nome Parte:	CPU CARD COMPONENT LAYOUT
File/Carrello:	www.v.r.electronic.com\scm1+1\scm1+1.dwg	Autorezzazione:		Codice:	SLTCPU55202
Scala:	/	Trattamento:	/	Profilo:	/

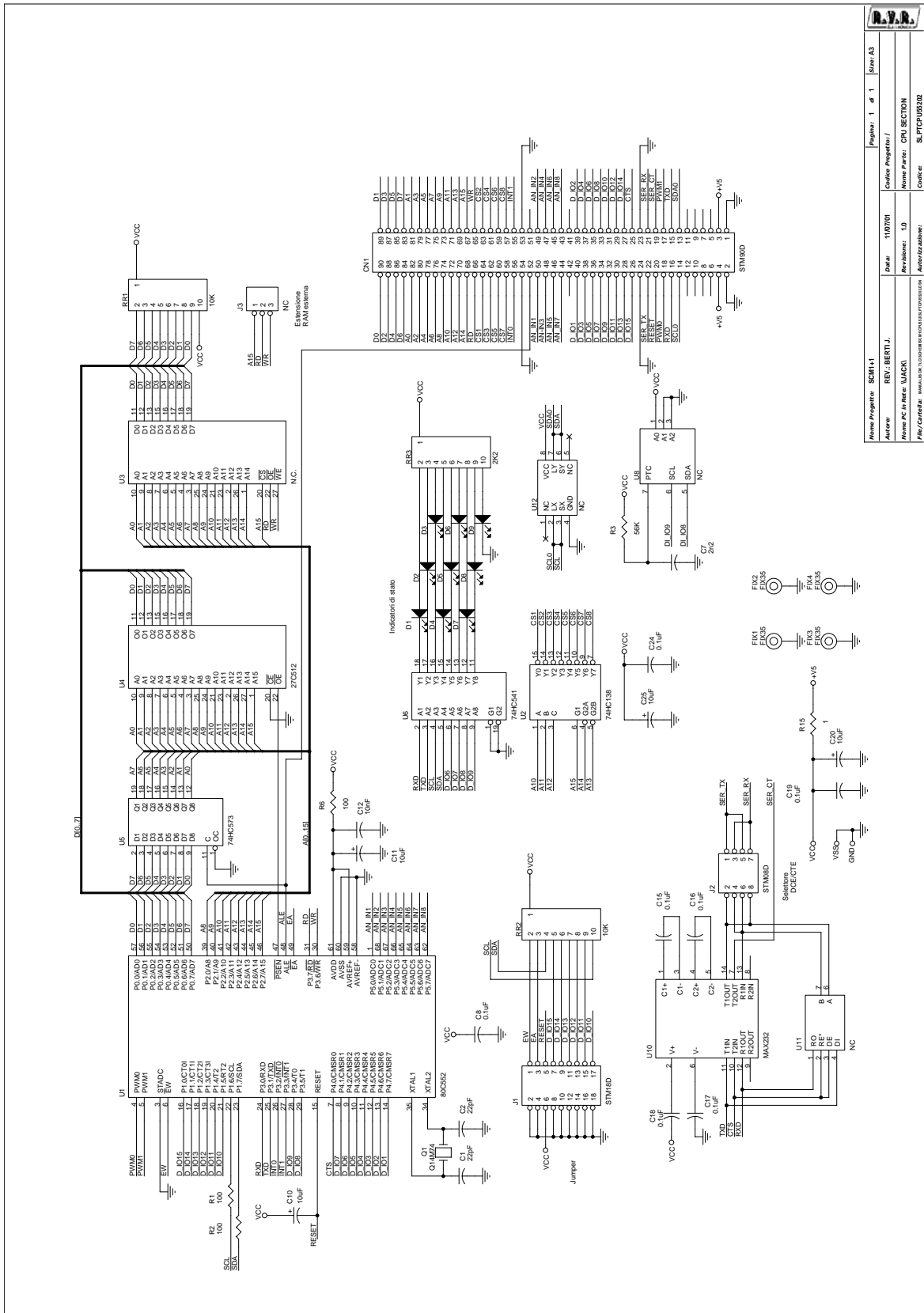

Nome Proprietario	SCM1+1	Revisioni	1.0
Autore	REV: BERTI.J.	Data	11/07/01
Nome PC in Rete	NAACK	Autorezzazione	Home Partner - CPU SECTION
File/Correlati	MAX232.DOC; RAM16M80.DOC; 27C512.DOC; 74HC273.DOC; 74HC541.DOC; 74HC138.DOC; PIC.DOC	Confer. Proprietario /	
		Confer. PC	
		Confer. CPU SECTION	
		Confer. SLT/CPUS5202	
		Confer. SLT/CPUS5202	

CPU SECTION		Bill Of Materials	Page1
Item	Quantity	Reference	Part
1	1	CN1	STM90D
2	2	C2,C1	22pF
3	1	C7	2n2
4	7	C8,C15,C16,C17,C18,C19, C24	0.1uF
5	4	C10,C11,C20,C25	10uF
6	1	C12	10nF
7	9	D1,D2,D3,D4,D5,D6,D7,D8, D9	LED-R3
8	4	FIX1, FIX2, FIX3, FIX4	FIX35
9	1	J1	STM18D
10	1	J2	STM08D
11	4	J3,U8,U11,U12	NC
12	1	Q1	Q14M74
13	2	RR2,RR1	10K
14	1	RR3	2K2
15	3	R1,R2,R6	100
16	1	R3	56K
17	1	R15	1
18	1	U1	80C552
19	1	U2	74HC138
20	1	U3	N.C.
21	1	U4	27C512
22	1	U5	74HC573
23	1	U6	74HC541
24	1	U10	MAX202ECPE

Pagina lasciata intenzionalmente in bianco

This page was intentionally left blank

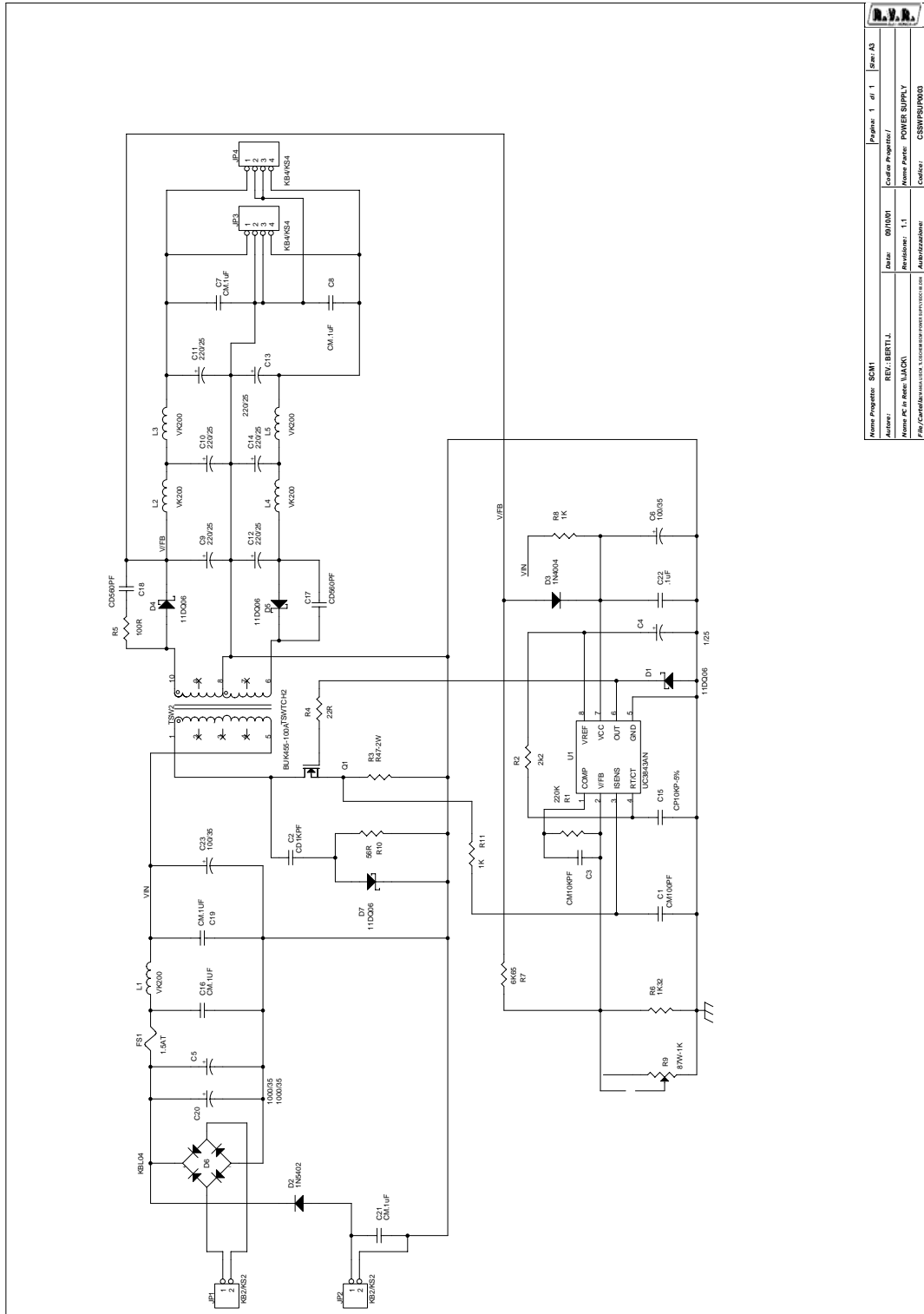

Nome Progetto:	SCM1	Figura:	1 di 1	Rev. / A:	
Autore:	REV. BERTILLO	Data:	09/09/01	Carata Progettata:	
Nome AC. In Rete (V.A.C.A.):		Revisione:	1.1	Nome Parte:	POWER SUPPLY
File/Caratteristiche:		Autore/Revisione:		Control:	CSSWPSUP003

POWER SUPPLY Bill Of Materials Page1

Item	Quantity	Reference	Part
1	1	C1	CM100PF
2	1	C2	CD1KPF
3	1	C3	CM10KPF
4	1	C4	1/25
5	2	C5,C20	1000/35
6	2	C6,C23	100/35
7	5	C7,C8,C16,C19,C21	CM.1uF
8	6	C9,C10,C11,C12,C13,C14	220/25
9	1	C15	CP10KP-5%
10	2	C18,C17	CD560PF
11	1	C22	.1uF
12	4	D1,D4,D5,D7	11DQ06
13	1	D2	1N5402
14	1	D3	1N4004
15	1	D6	KBL04
16	1	FS1	1.5AT
17	2	JP1,JP2	KB2/KS2
18	2	JP3,JP4	KB4/KS4
19	5	L1,L2,L3,L4,L5	VK200
20	1	Q1	BUK455-100A
21	1	R1	220K
22	1	R2	2k2
23	1	R3	R47-2W
24	1	R4	22R
25	1	R5	100R
26	1	R6	1K32
27	1	R7	6K65
28	2	R11,R8	1K
29	1	R9	87W-1K
30	1	R10	56R
31	1	TSW2	TSWTCH2
32	1	U1	UC3843AN

Pagina lasciata intenzionalmente in bianco

This page was intentionally left blank

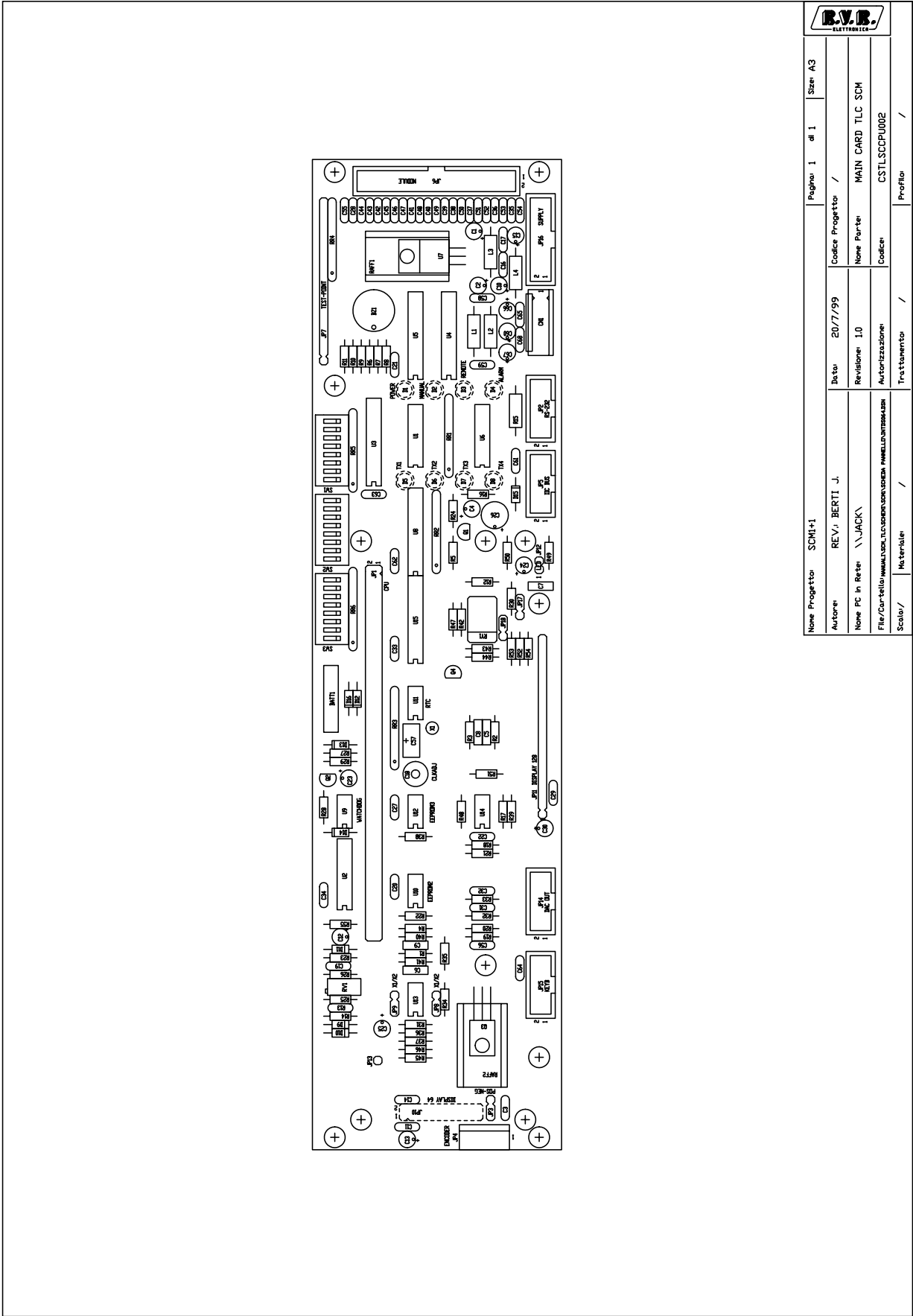

Nome Progetto		SCM1+1		Pagina 1 di 1		Size: A3	
Autore	REV. BERTI J.	Data	20/7/99	Codice Progetto	/		
Nome PC in Rete	\\JACK\	Revisione	I.0	Nome Parte	MAIN CARD TLC SCM		
File/Carrello	\\MAILS\MAILS\TUTTO\SCM\PC\MAIN\MAIN\MAIN\MAIN\MAIN	Autorizzazione	/	Codice	CSTLSCCPU002		
Scala	Moltiplicabile	Traffamento	/	Profilo	/		

Nome Progetto: SCM1+1	Revisione: 1	di: 1	Foglio: 24
Autore: R.V.R. ELETTRONICA	Disegnato: R.V.R. ELETTRONICA	Verificato: R.V.R. ELETTRONICA	Approvato: R.V.R. ELETTRONICA
Nome Cliente: R.V.R. ELETTRONICA	Interno: R.V.R. ELETTRONICA	Interno: R.V.R. ELETTRONICA	Interno: R.V.R. ELETTRONICA
Interno: R.V.R. ELETTRONICA	Interno: R.V.R. ELETTRONICA	Interno: R.V.R. ELETTRONICA	Interno: R.V.R. ELETTRONICA

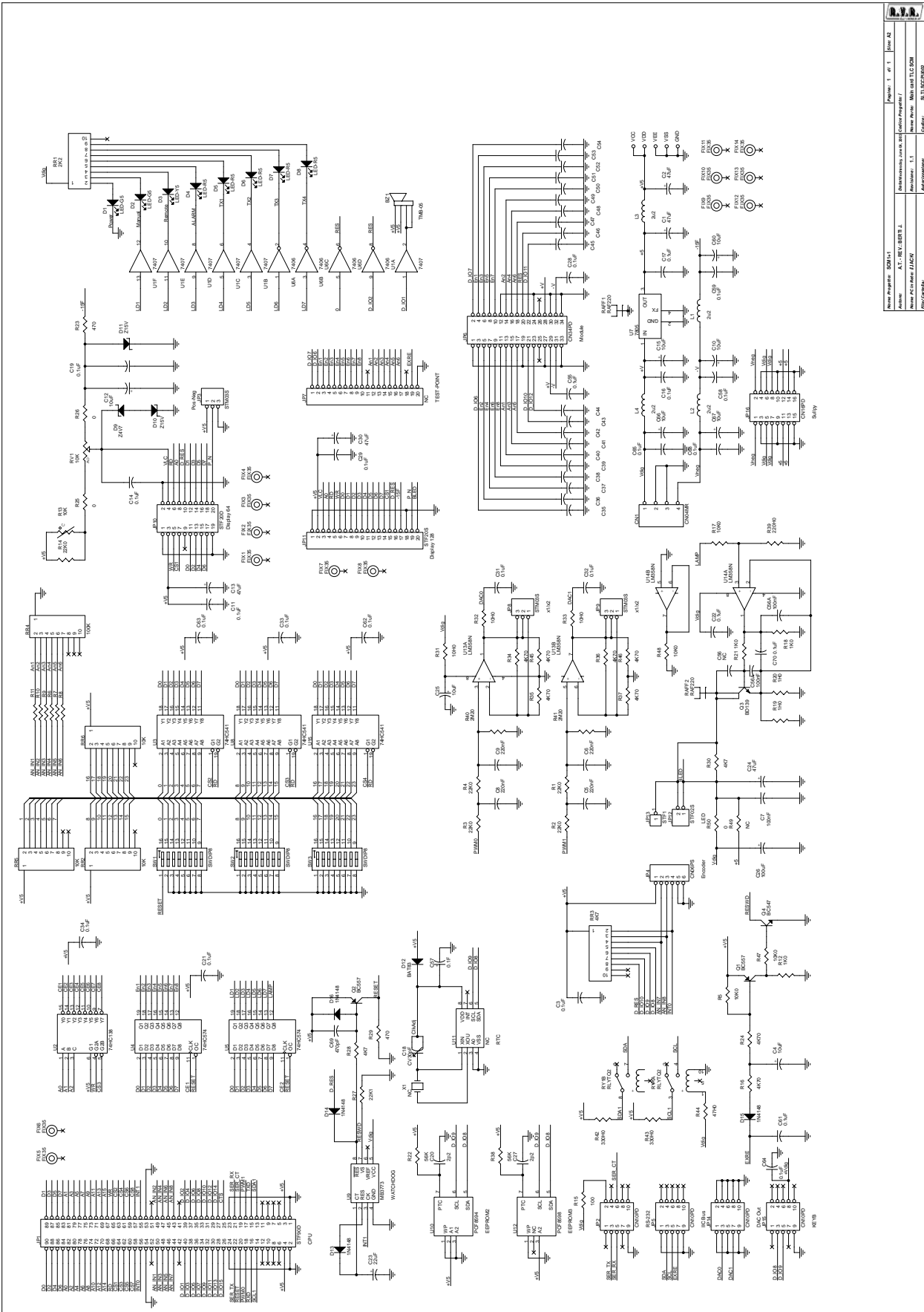

Main card TLCSCM Bill Of Materials

Page 1

Item	Quantity	Reference	Part
1	1	BZ1	TMB-05
2	1	CN1	CN04MR
3	5	C1, C2, C13, C24, C30	47uF
4	24	C3, C11, C14, C16, C17, C19, C21, C22, C28, C29, C31, C32, C33, C34, C55, C58, C59, C61, C62, C63, C64, C65, C68, C70	0.1uF
5	8	C4, C10, C12, C15, C25, C60, C66, C67	10uF
6	4	C5, C6, C8, C9	220nF
7	2	C7, C56A	100nF
8	1	C18	CV30pF
9	2	C27, C20	2p2
10	1	C23	22uF
11	1	C26	100uF
12	20	C35, C36, C37, C38, C39, C40, C41, C42, C43, C44, C45, C46, C47, C48, C49, C50, C51, C52, C53, C54	100pF
13	1	C56	4n7
14	1	C57	0.1F
15	1	C69	470pF
16	2	D2, D1	LED-G5
17	1	D3	LED-Y5
18	5	D4, D5, D6, D7, D8	LED-R5
19	1	D9	Z4V7
20	2	D10, D11	Z15V
21	1	D12	BAT83
22	4	D13, D14, D15, D16	1N4148
23	14	FIX1, FIX2, FIX3, FIX4, FIX5, FIX6, FIX7, FIX8, FIX9, FIX10, FIX11, FIX12, FIX13, FIX14	FIX35
24	1	JP1	STF90D
25	4	JP2, JP5, JP14, JP15	CN10PD
26	3	JP3, JP8, JP9	STM03S
27	1	JP4	CN06PS
28	1	JP6	CN34PD
29	4	X1, JP7, U11, R49	NC
30	1	JP10	STF20D
31	1	JP11	STF20S
32	1	JP12	STF02S
33	1	JP13	STF1
34	1	JP16	CN16PD
35	4	L1, L2, L3, L4	2u2
36	2	Q2, Q1	BC557
37	1	Q3	BD139
38	1	Q4	BC547
39	2	RAFF2, RAFF1	RAF220
40	1	RR1	2K2
41	5	RV1, RR2, RR5, RR6, R13	10K
42	3	RR3, R28, R30	4K7
43	1	RR4	100K
44	1	RY1	RLYTQ2

45	5	R1,R2,R3,R4,R14	22K0
46	4	R5,R17,R47,R48	10K0
47	9	R6,R7,R8,R9,R10,R11,R12, R18,R21	1K0
48	1	R15	100
49	8	R16,R24,R34,R35,R36,R37, R45,R46	4K70
50	2	R19,R20	1H0
51	2	R38,R22	56K
52	2	R23,R29	470
53	3	R25,R26,R50	0
54	1	R27	22K1
55	3	R31,R32,R33	10H0
56	1	R39	220H0
57	2	R40,R41	2M20
58	2	R42,R43	330H0
59	1	R44	47H0
60	3	SW1,SW2,SW3	SWDIP8
61	1	U1	7407
62	1	U2	74HC138
63	3	U3,U8,U15	74HC541
64	2	U4,U5	74HC574
65	1	U6	7406
66	1	U7	7805
67	1	U9	MB3773
68	1	U10	PCF8594
69	1	U12	PCF8598
70	2	U14,U13	LM358N

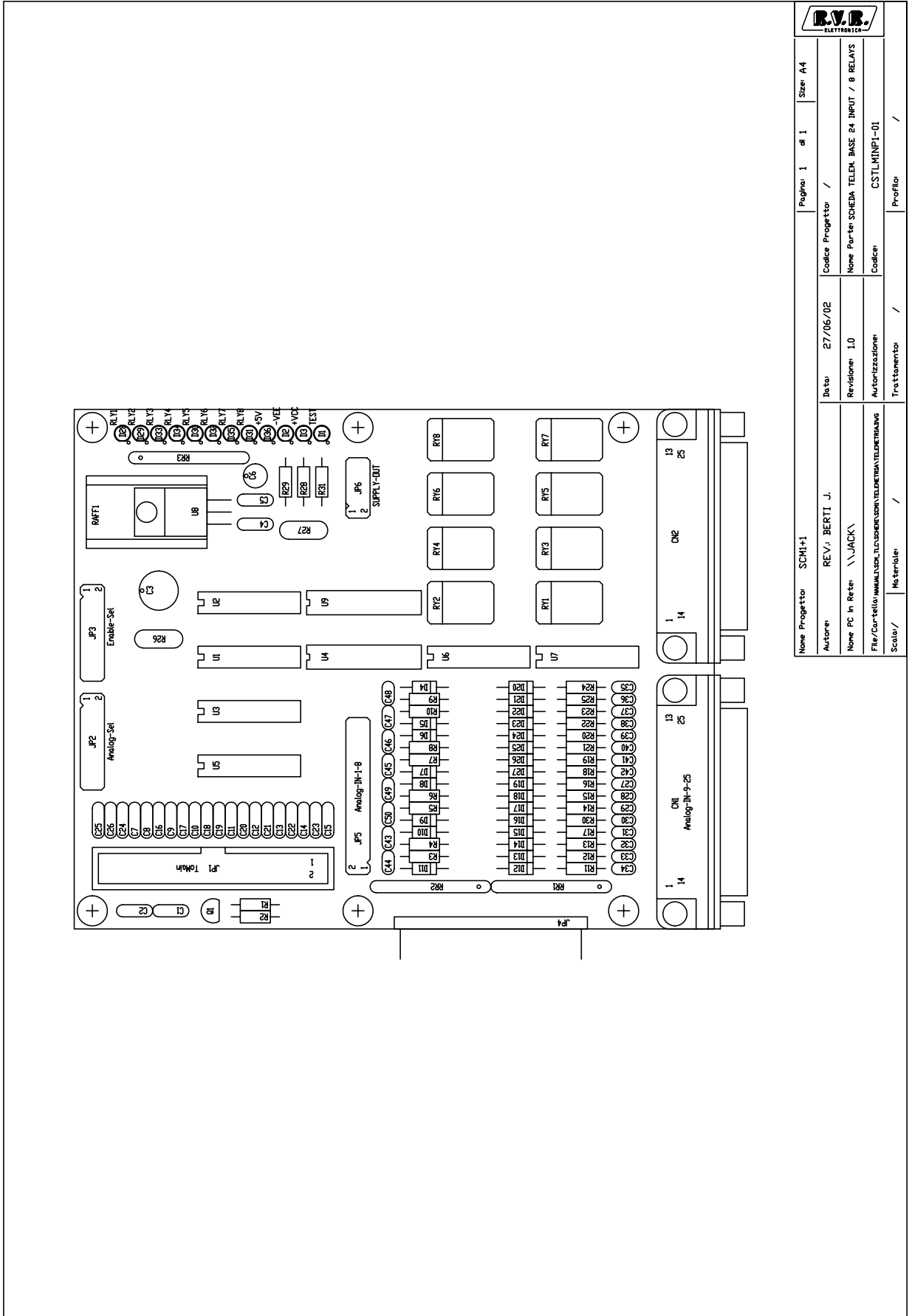

Nome Progetto: SCM1+1		Pagina: 1 di 1		Stato: A4	
Autore: REV: BERTI J.		Data: 27/06/02		Codice Progetto: /	
Nome PC in Rete: \\JACK\		Revisione: 1.0		Nome Porte SCHEMA TELEF. BASE 24 INPUT / 8 RELAYS	
File/Carrello: \\MMS\user\lucio\documenti\relays\SCM1+1\SCM1+1.MXD		Autorezzazione		Codice: CSTLMINP1-01	
Scala: /		Trattamento: /		Profilo: /	

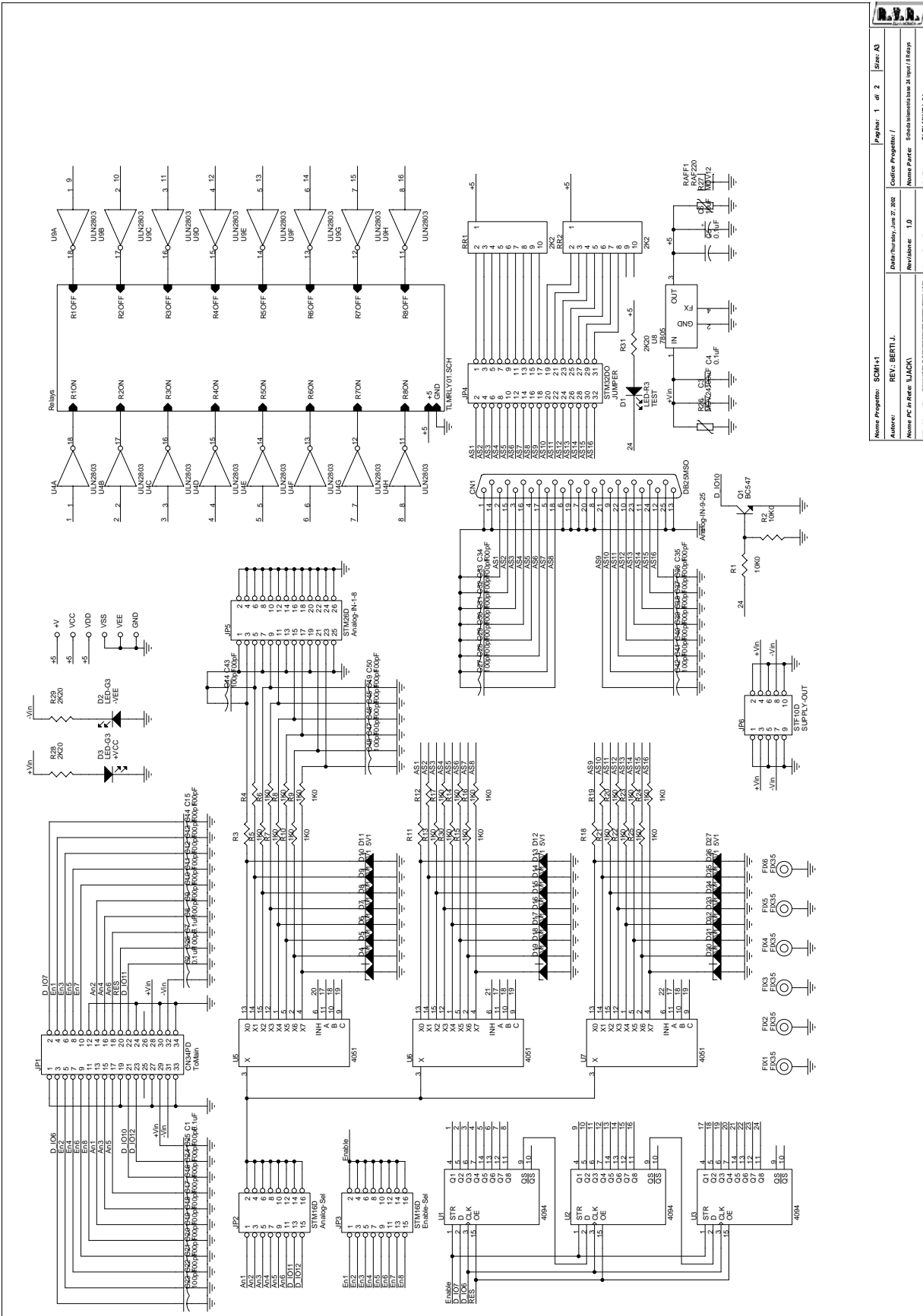

Nome Progetto:	SCM1+1	Progetto:	1	di	2	Size:	A3
Autore:	REV. BERTI.J.	Data:	10/09/01	Conto:	Progetto /		
Nome PC in Rete:	NAACK	Revisione:	1.0	Nome Part:	Schema in base al tipo / 8 Keys		
File/Caricaz.:	...	Autore:		Autore:			

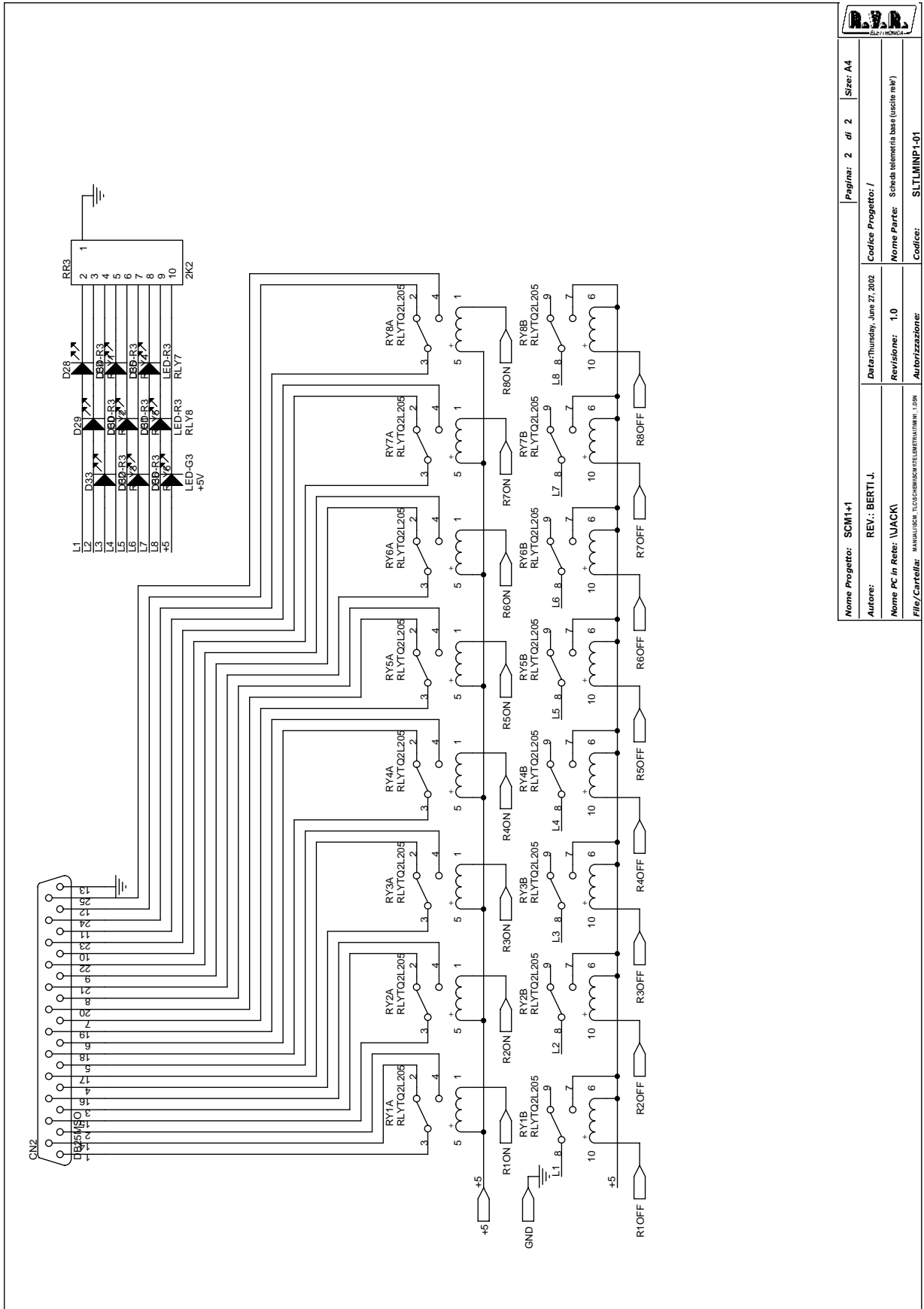

		Pagina: 2 di 2		Size: A4	
Nome Progetto: SCM1+1		Codice Progetto: /		Data: Thursday, June 27, 2002	
Autore: REV.: BERTI J.		Nome Parte: Scheda telemetria base (uscita rel.)		Revisione: 1.0	
Nome PC in Rete: \JACK		File/Cartella: \MANUAL\SCM1+1\SCHEMATIC\SCM1+1.MNH.1.0.BR		Autorizzazione:	
				Codice: SCLMINP1-01	

Item	Quantity	Reference	Part
1	2	CN2, CN1	DB25MSO
2	5	C1, C2, C4, C5, C7	0.1uF
3	1	C3	100uF
4	1	C6	10uF
5	43	C8, C9, C10, C11, C12, C13, C14, C15, C16, C17, C18, C19, C20, C21, C22, C23, C24, C25, C26, C27, C28, C29, C30, C31, C32, C33, C34, C35, C36, C37, C38, C39, C40, C41, C42, C43, C44, C45, C46, C47, C48, C49, C50	100pF
6	9	D1, D28, D29, D30, D31, D32, D33, D34, D35	LED-R3
7	3	D2, D3, D36	LED-G3
8	24	D4, D5, D6, D7, D8, D9, D10, D11, D12, D13, D14, D15, D16, D17, D18, D19, D20, D21, D22, D23, D24, D25, D26, D27	5V1
9	6	FIX1, FIX2, FIX3, FIX4, FIX5, FIX6	FIX35
10	1	JP1	CN34PD
11	2	JP3, JP2	STM16D
12	1	JP4	STM32DO
13	1	JP5	STM26D
14	1	JP6	STF10D
15	1	Q1	BC547
16	1	RAFF1	RAF220
17	3	RR1, RR2, RR3	2K2
18	8	RY1, RY2, RY3, RY4, RY5, RY6, RY7, RY8	RLYTQ2L205
19	2	R2, R1	10K0
20	24	R3, R4, R5, R6, R7, R8, R9, R10, R11, R12, R13, R14, R15, R16, R17, R18, R19, R20, R21, R22, R23, R24, R25, R30	1K0
21	1	R26	MOV24
22	1	R27	MOV12
23	3	R28, R29, R31	2K20
24	3	U1, U2, U3	4094
25	2	U4, U9	ULN2803
26	3	U5, U6, U7	4051
27	1	U8	7805

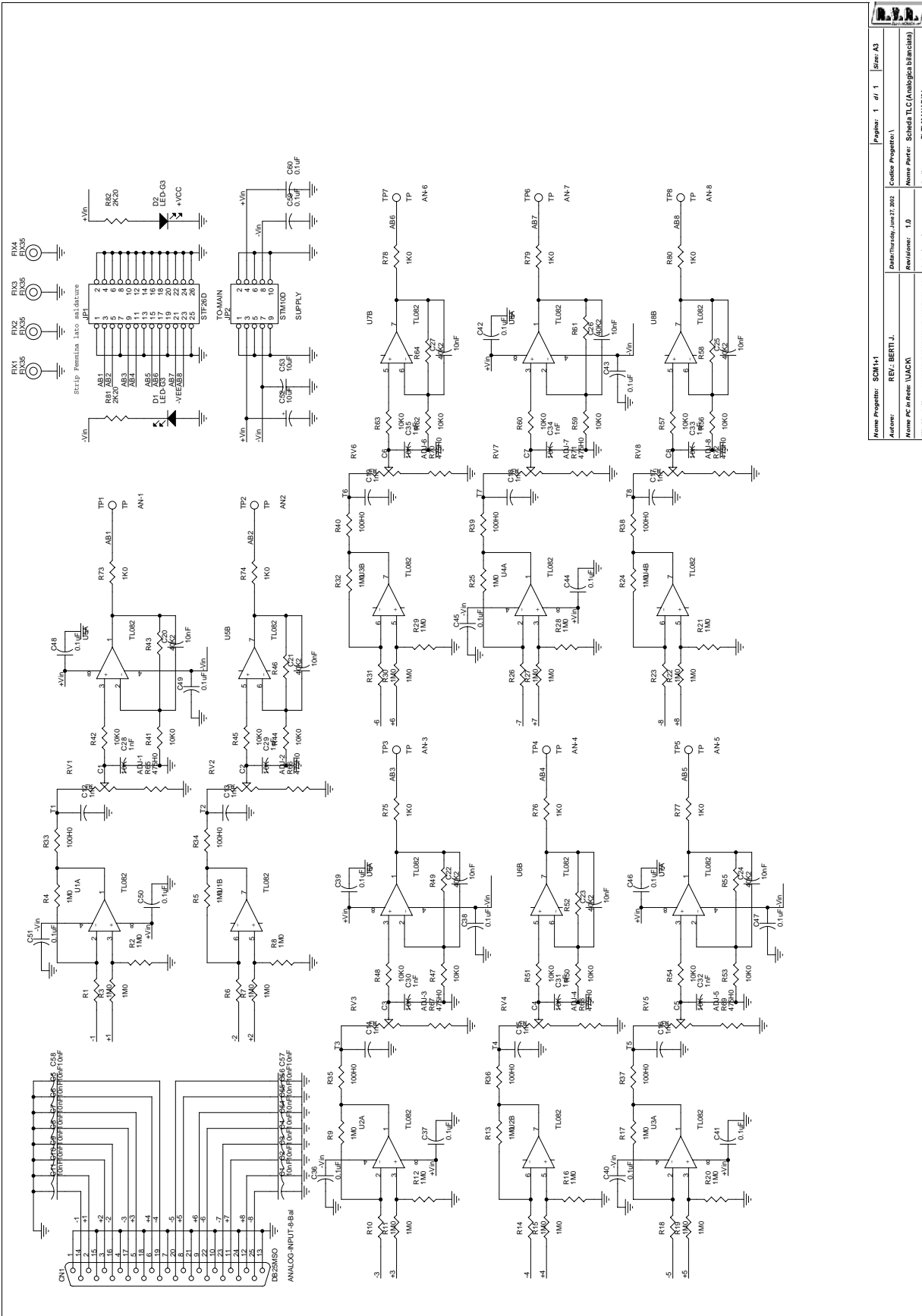

Nome Progetto: SCM1+1	Pagina: 1 di 1	Size: A3
Autore: REI: BERTI L.	Data: Thursday, June 27, 2002	Codice Progetto: 1
Nome PC in Rete: UACCA	Nome Perifer: Scheda T.L.C. (Analogica bilanciata)	Revisione: 1.0
File/Caratteristiche: manuali U7A, U7B, U7C, STR26D, TL082, TL084, TL082, TL082	Autore/Disegnatore: SUTLMANABI01	Codice:

Scheda TLC	Bill Of Materials		Page1
Item	Quantity	Reference	Part
1	1	CN1	DB25MSO
2	24	C1, C2, C3, C4, C5, C6, C7, C8, C9, C10, C11, C20, C21, C22, C23, C24, C25, C26, C27, C54, C55, C56, C57, C58	10nF
3	16	C12, C13, C14, C15, C16, C17, C18, C19, C28, C29, C30, C31, C32, C33, C34, C35	1nF
4	18	C36, C37, C38, C39, C40, C41, C42, C43, C44, C45, C46, C47, C48, C49, C50, C51, C59, C60	0.1uF
5	2	C53, C52	10uF
6	2	D2, D1	LED-G3
7	4	FIX1, FIX2, FIX3, FIX4	FIX35
8	1	JP1	STF26D
9	1	JP2	STM10D
10	8	RV1, RV2, RV3, RV4, RV5, RV6, RV7, RV8	10K
11	32	R1, R2, R3, R4, R5, R6, R7, R8, R9, R10, R11, R12, R13, R14, R15, R16, R17, R18, R19, R20, R21, R22, R23, R24, R25, R26, R27, R28, R29, R30, R31, R32	1M0
12	8	R33, R34, R35, R36, R37, R38, R39, R40	100H0
13	16	R41, R42, R44, R45, R47, R48, R50, R51, R53, R54, R56, R57, R59, R60, R62, R63	10K0
14	8	R43, R46, R49, R52, R55, R58, R61, R64	40K2
15	8	R65, R66, R67, R68, R69, R70, R71, R72	475H0
16	8	R73, R74, R75, R76, R77, R78, R79, R80	1K0
17	2	R81, R82	2K20
18	8	TP1, TP2, TP3, TP4, TP5, TP6, TP7, TP8	TP
19	8	U1, U2, U3, U4, U5, U6, U7, U8	TL082

Pagina lasciata intenzionalmente in bianco

This page was intentionally left blank

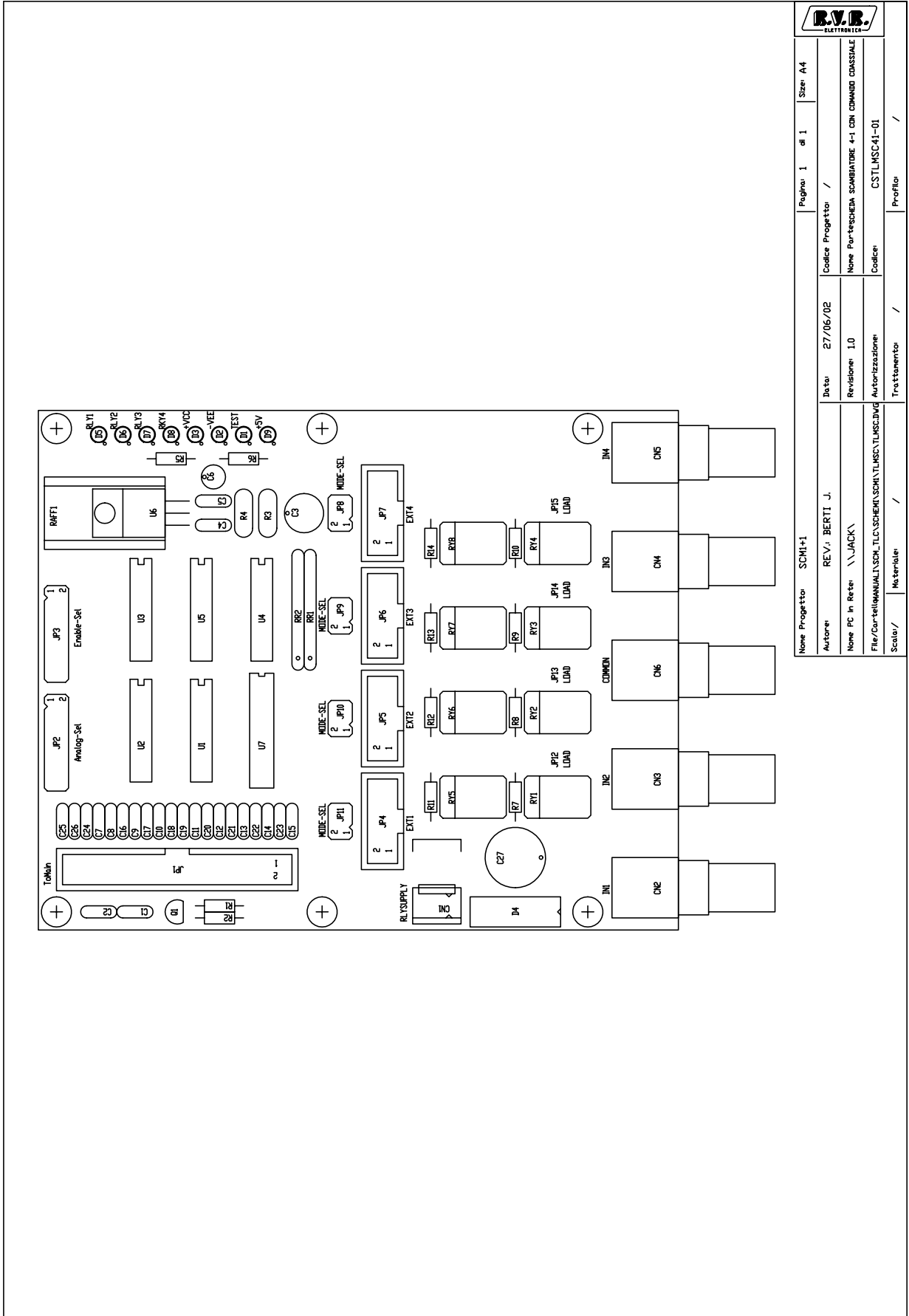

Nome Progetto: SCM1+1		Pagina: 1 di 1		Sera: A4	
Autore: REV: BERTI J.	Data: 27/06/02	Codice Progetto: /		Nome Progetto: SCMBATRE 4-1 CON COMANDO CLASSIALE	
Nome PC in Rete: \\JACK\	Revisione: 1.0	Nome Progetto: SCMBATRE 4-1 CON COMANDO CLASSIALE		Codice: CSTL MSC41-01	
File/Current/Manual/SCM_TLC/SCHEMATICI/SCM1+1/SC1.DWG	Autorezzazione	Trattamento: /		Profilo: /	
Scala: /	Master/Slave	Trattamento: /		Profilo: /	

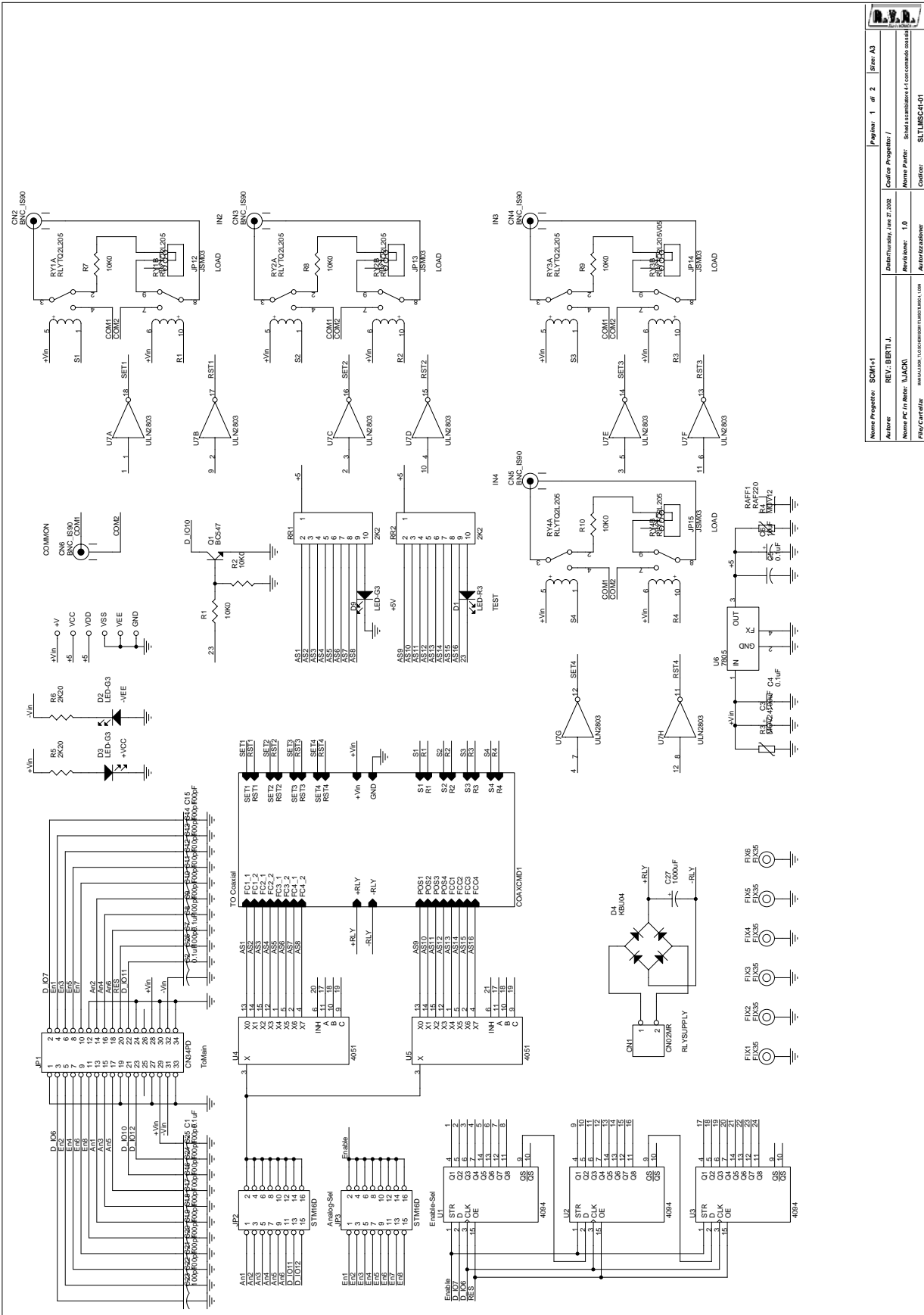

Nome Progetto:	SCM1+1	Revisione:	1.0
Autore:	REV: BERTU.J.	Autore:	SCM1+1
Nome PC in Rete:	UJACKA	Autore:	SCM1+1
File/Carrello:	www.rvr.it	Autore:	SCM1+1

Nome Progetto:	SCM1+1	Revisione:	1.0
Autore:	REV: BERTU.J.	Autore:	SCM1+1
Nome PC in Rete:	UJACKA	Autore:	SCM1+1
File/Carrello:	www.rvr.it	Autore:	SCM1+1

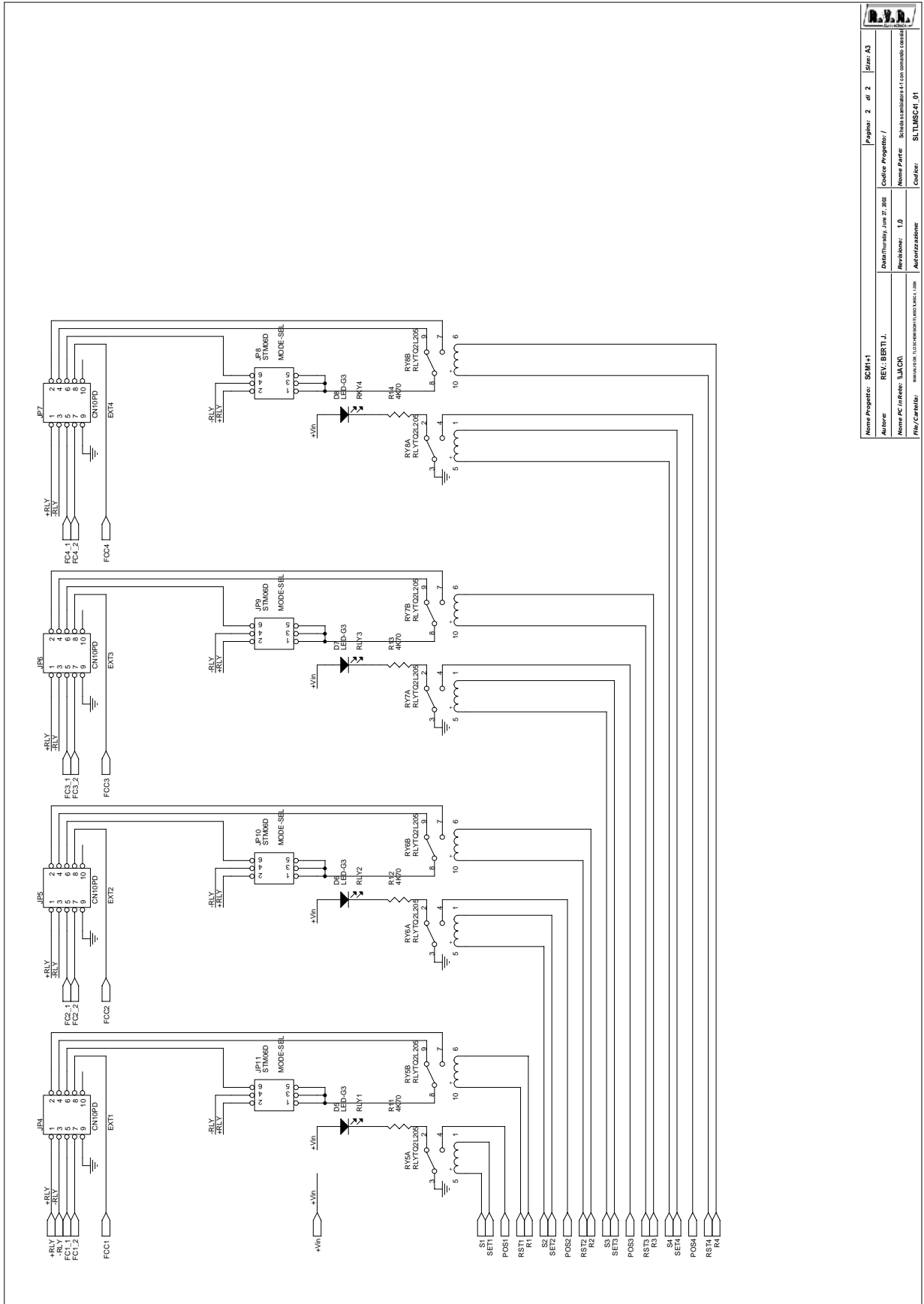

Nome Progetto: SCM1+1	Page: 2 di 2	Rev: A3
Autore: REV: BERTI J.	Conferma Progetto: /	
Nome PC in Rete: UACM	Data Thursday, June 27, 2002	Nome Partire: Scheda controllata L1 con comando casale
File/Caratteristiche: ...	Revisione: 1.0	Autore/Revisione: SI, LLMSC41_01

Scheda scambiatore Bill Of Materials

Pagel

Item	Quantity	Reference	Part
1	1	CN1	CN02MR
2	5	CN2, CN3, CN4, CN5, CN6	BNC_IS90
3	5	C1, C2, C4, C5, C7	0.1uF
4	1	C3	100uF
5	1	C6	10uF
6	19	C8, C9, C10, C11, C12, C13, C14, C15, C16, C17, C18, C19, C20, C21, C22, C23, C24, C25, C26	100pF
7	1	C27	1000uF
8	1	D1	LED-R3
9	7	D2, D3, D5, D6, D7, D8, D9	LED-G3
10	1	D4	KBU04
11	6	FIX1, FIX2, FIX3, FIX4, FIX5, FIX6	FIX35
12	1	JP1	CN34PD
13	2	JP3, JP2	STM16D
14	4	JP4, JP5, JP6, JP7	CN10PD
15	4	JP8, JP9, JP10, JP11	STM06D
16	4	JP12, JP13, JP14, JP15	JSM03
17	1	Q1	BC547
18	1	RAFF1	RAF220
19	2	RR1, RR2	2K2
20	8	RY1, RY2, RY3, RY4, RY5, RY6, RY7, RY8	RLYTQ2L205
21	1	RY3	RLYTQ2L205V05
22	6	R1, R2, R7, R8, R9, R10	10K0
23	1	R3	MOV24
24	1	R4	MOV12
25	2	R6, R5	2K20
26	4	R11, R12, R13, R14	4K70
27	3	U1, U2, U3	4094
28	2	U4, U5	4051
29	1	U6	7805
30	1	U7	ULN2803

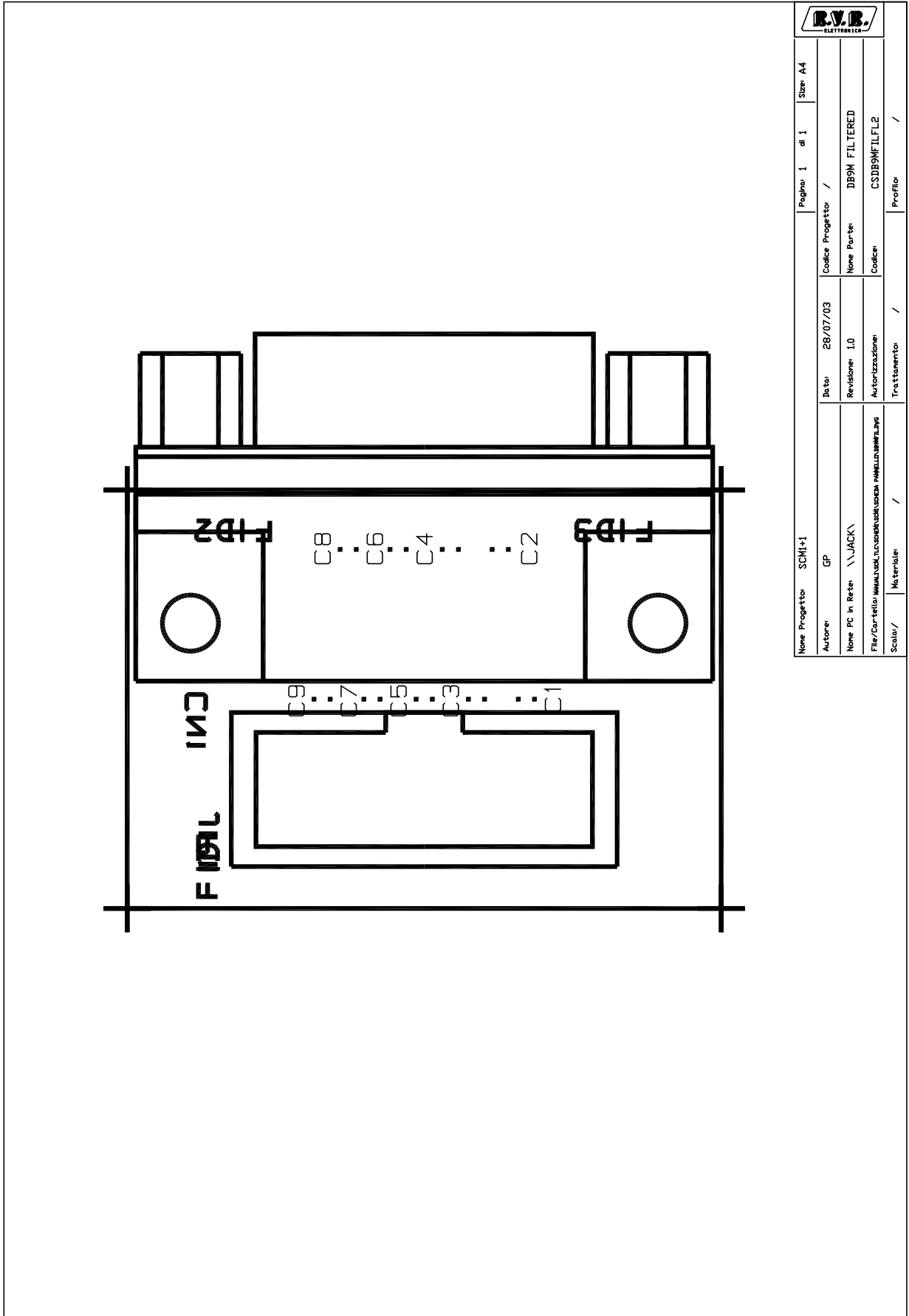

Nome Progetto		SCM1+1		Pagina 1 di 1		Size A4	
Autore	GP	Data	28/07/03	Codice Progetto	/		
Nome PC in Rete	\\JACK	Revisione	1.0	Nome Parte	DB9M FILTERED		
File/Carrello	\\mms\dat\inc\csm\scm1+1\scm1+1.dwg	Autorizzazione		Codice	CSD9MFLFL2		
Scala	/	Titolazione	/	Profilo	/		

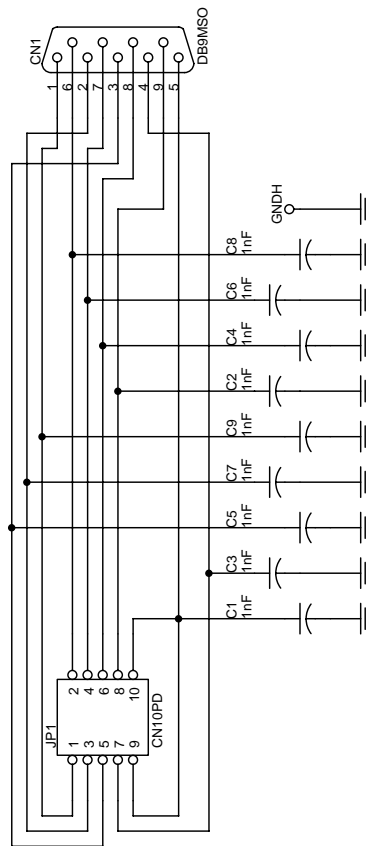

		Pagina: 1	di 1	Size: A4
Nome Progetto: SCM1+1		Codice Progettore: /		
Autore: A.T.	Data: 28/07/03	Nome Parte: DB9M FILTERED		
Nome PC in Rete: \\JACK1	Revisione: 1.0	Codice: CSDB9MFILFL2		
File/ Cartella: MANUALE_TECNICO_SCH_001_PANNELLO_001	Autore/Revisione:			

SLDB9MFILFL1 Bill Of Materials

Page1

Item	Q.ty	Reference	Part
------	------	-----------	------

1	1	CN1	DB9MSO
2	9	C1,C2,C3,C4,C5,C6,C7,C8, C9	1nF
3	1	JP1	CN10PD

Pagina lasciata intenzionalmente in bianco

This page was intentionally left blank