

TELINK-SNMP2

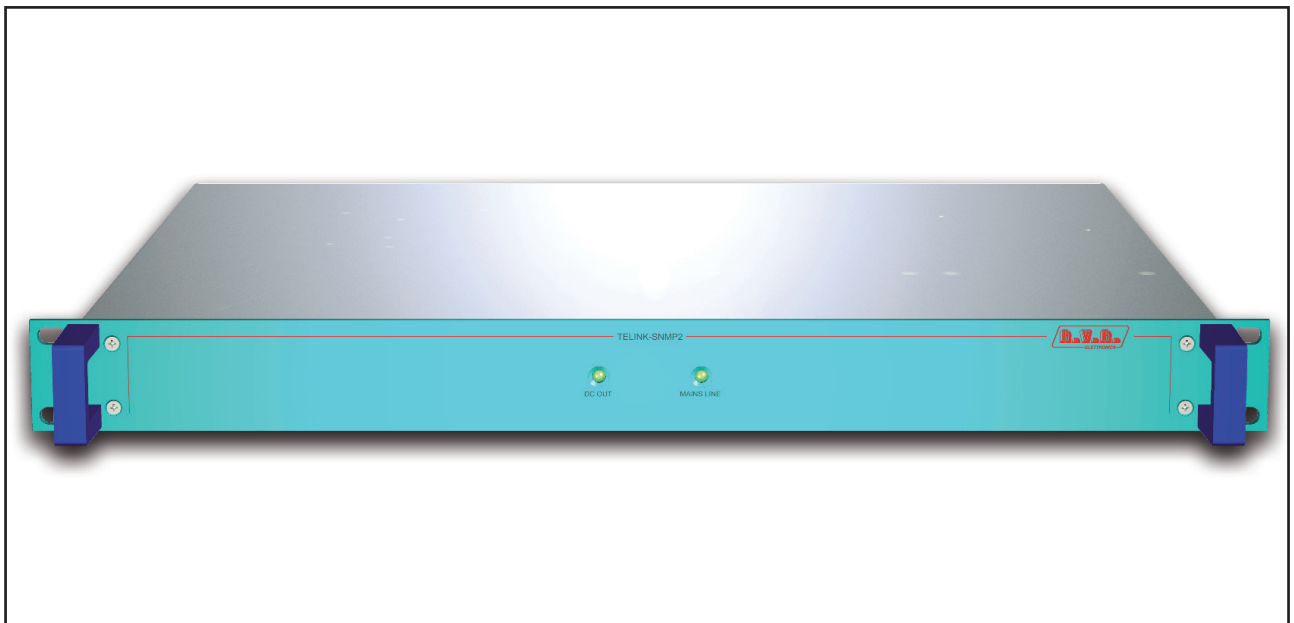

User Manual Volume 1

File Name: TELINK-SNMP2_ITA_1.0.indb

Version: 1.0

Date: 13/03/2009

Revision history

Date	Version	Reason	Editor
13/03/2009	1.0	First Edition	P. Tassin

TELINK-SNMP2 - User Manual
Version 1.0

© Copyright 2009

R.V.R. Elettronica SpA

Via del Fonditore 2/2c - 40138 - Bologna (Italia)

Telephone: +39 051 6010506

Fax: +39 051 6011104

Email: info@rvr.it

Web: www.rvr.it

All rights reserved

Printed and bound in Italy. No part of this manual may be reproduced, memorized or transmitted in any form or by any means, electronic or mechanic, including photocopying, recording or by any information storage and retrieval system, without written permission of the copyright owner.

All other trademark, trade name or logo used are the property of their respective owners.

Table of Contents

1. Preliminary Instructions	1
2. Warranty	1
3. First Aid	2
3.1 Treatment of electrical shocks	2
3.2 Treatment of electrical Burns	2
4. Unpacking	3
4.1 General Description	3
5. Installation and configuration procedure	5
5.1 Preparation	5
5.2 First Power-On and Set-Up	6
5.3 Management Firmware	8
6. External Description	14
6.1 Front Panel	14
6.2 Rear Panel	15
6.3 Connector Description	16
7. Technical Specifications	18
8. Working Principles	19
8.1 Power Supply	19
8.2 Panel Card	19
8.3 Main card	20
8.4 SNMP ANTLAN Card	20
9. Identification and Access to the Modules	23
9.1 Upper View	23

This page was intentionally left blank

IMPORTANT

The symbol of lightning inside a triangle placed on the product, evidences the operations for which is necessary gave it full attention to avoid risk of electric shocks.



The symbol of exclamation mark inside a triangle placed on the product, informs the user about the presence of instructions inside the manual that accompanies the equipment, important for the efficacy and the maintenance (repairs).

1. Preliminary Instructions

• General foreword

The equipment in object is to considering for uses, installation and maintenance from "trained" or "qualified" staff, they conscious of the risks connected to operate on electronic and electrical circuits electrical.

The "trained" definition means staff with technical knowledge about the use of the equipment and with responsibility regarding the own safety and the other not qualified staff safety place under his directed surveillance in case of works on the equipment.

The "qualified" definition means staff with instruction and experience about the use of the equipment and with responsibility regarding the own safety and the other not qualified staff safety place under his directed surveillance in case of works on the equipment.

 **WARNING: The machine can be equipped with an ON/OFF switch which could not remove completely voltages inside the machine. It is necessary to have disconnected the feeding cord, or to have switched off the control panel, before to execute technical operations, making sure himself that the safety connection to ground is connected.**

The technical interventions that expect the equipment inspection with circuits under voltage must be carry out from trained and qualified staff in presence of a second trained person that it is ready to intervene removing voltage in case of need.

R.V.R. Elettronica SpA doesn't assume responsibility for injury or damage resulting from improper procedures or practices by untrained/unqualified personnel in the handling of this unit.

 **WARNING: The equipment is not water resistant and an infiltration could seriously compromise its correct operation. In order to prevent fires or electric shocks, do not expose the equipment to rain, infiltrations or humidity.**

Please observe all local codes and fire protection standards during installation and use of this unit.

 **WARNING: The equipment has to its inside exposed parts to risk of electric shock, always disconnect power before opening covers or removing any part of this unit.**

Fissures and holes are supplied for the ventilation in order to assure a reliable efficacy of the product that for protect itself from excessive heating, these fissures do not have to be obstructed or to be covered. The fissures doesn't be obstructed in no case. The product must not be incorporated in a rack, unless it is supplied with a suitable ventilation or that the manufacturer's instructions are been followed.

 **WIRING: This equipment can irradiate radio frequency energy and if it's not installed following the instructions contained in the manual and local regulations it could generate interferences in radio communications.**

 **WIRING: This device has a connection to ground on the power cord and on the chassis. Check that they are correctly connected.**

Operate with this device in a residential ambient can cause radio disturbs; in this case, it can be demanded to the user to take adequate measures.

Specifications and informations contained in this manual are furnished for information only, and are subject to change at any time without notice, and should not be construed as a commitment by R.V.R. Elettronica SpA.

The R.V.R. Elettronica SpA assumes no responsibility or liability for any errors or inaccuracies that may appear in this manual, including the products and software described in it; and it reserves the right to modify the design and/or the technical specifications of the product and this manual without notice.

• **Warning regarding the use designated and the use limitations of the product.**

This product is an transmitter radio indicated for the audio broadcasting service in frequency modulation. It uses working frequencies that are not harmonized in the states of designated user.

The user of this product must obtain from the Authority for spectrum management in the state of designated user the appropriate authorization to use the radio spectrum, before putting in exercise this equipment.

The working frequency, the transmitter power, let alone other specifications of the transmission system are subject to limitation and defined in the authorization obtained.

2. Warranty

R.V.R. Electronics S.P.A. guarantees absence of manufacturing defect and the good operation for the products, within the provided terms and conditions.

Please read the terms carefully, because the purchase of the product or acceptance of order confirmation, constitutes acceptance of the terms and conditions.

For the last legal terms and conditions, please visit our web site (WWW.RVR.IT) wich may also be changed, removed or updated for any reason without prior notice.

Warranty will be void in cases of opened products, physical damage, misuse, modification, repair by unauthorised persons, carelessness and using the product for other purpose than its intended use.

In case of defect, proceed like described in the following:

- 1 Contact the dealer or distributor where you purchased the unit. Describe the problem and, so that a possible easy solution can be detected.

Dealers and Distributors are supplied with all the information about problems that may occur and usually they can repair the unit quicker than what the manufacturer could do. Very often installing errors are discovered by dealers.

- 2 If your dealer cannot help you, contact R.V.R. Elettronica and explain the problem. If it is decided to return the unit to the factory, R.V.R. Elettronica will mail you a regular authorization with all the necessary instructions to send back the goods;

- 3 When you receive the authorization, you can return the unit. Pack it carefully for the shipment, preferably using the original packing and seal the package perfectly. The customer always assumes the risks of loss (i.e.,

R.V.R. is never responsible for damage or loss, until the package reaches R.V.R. premises. For this reason, we suggest you to insure the goods for the whole value. Shipment must be effected C.I.F. (PREPAID) to the address specified by R.V.R.'s service manager on the authorization



DO NOT RETURN UNITS WITHOUT OUR AUTHORIZATION AS THEY WILL BE REFUSED

- 4 Be sure to enclose a written technical report where mention all the problems found and a copy of your original invoice establishing the starting date of the warranty.

Replacement and warranty parts may be ordered from the following address. Be sure to include the equipment model and serial number as well as part description and part number.



R.V.R. Elettronica SpA
Via del Fonditore, 2/2c
40138 BOLOGNA ITALY
Tel. +39 051 6010506

3. First Aid

The personnel employed in the installation, use and maintenance of the device, shall be familiar with theory and practice of first aid.

3.1 Treatment of electrical shocks

3.1.1 If the victim is not responsive

Follow the A-B-C's of basic life support.

- Place victim flat on his back on a hard surface.
- Open airway: lift up neck, push forehead back (**Figure 1**).

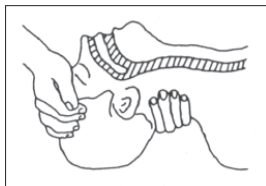

Figure 1

- clear out mouth if necessary and observe for breathing
- if not breathing, begin artificial breathing (**Figure 2**): tilt head, pinch nostrils, make airtight seal, four quick full breaths. Remember mouth to mouth resuscitation must be commenced as soon as possible.



Figure 2

- Check carotid pulse (**Figure 3**); if pulse is absent, begin artificial circulation (**Figure 4**) depressing sternum (**Figure 5**).

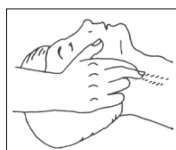

Figure 3

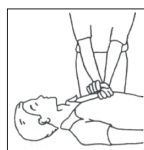

Figure 4

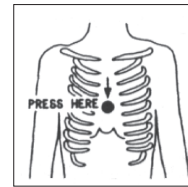

Figure 5

- In case of only one rescuer, 15 compressions alternated to two breaths.
- If there are two rescuers, the rhythm shall be of one breath each 5 compressions.
- Do not interrupt the rhythm of compressions when the second person is giving breath.
- Call for medical assistance as soon as possible.

3.1.2 If victim is responsive

- Keep them warm.
- Keep them as quiet as possible.
- Loosen their clothing (a reclining position is recommended).
- Call for medical help as soon as possible.

3.2 Treatment of electrical Burns

3.2.1 Extensive burned and broken skin

- Cover area with clean sheet or cloth.
- Do not break blisters, remove tissue, remove adhered particles of clothing, or apply any salve or ointment.
- Treat victim for shock as required.
- Arrange transportation to a hospital as quickly as possible.
- If arms or legs are affected keep them elevated.

If medical help will not be available within an hour and the victim is conscious and not vomiting, give him a weak solution of salt and soda: 1 level teaspoonful of salt and 1/2 level teaspoonful of baking soda to each quart of water (neither hot or cold).

Allow victim to sip slowly about 4 ounces (half a glass) over a period of 15 minutes.

Discontinue fluid if vomiting occurs.

DO NOT give alcohol.

3.2.2 Less severe burns

- Apply cool (not ice cold) compresses using the cleansed available cloth article.
- Do not break blisters, remove tissue, remove adhered particles of clothing, or apply salve or ointment.
- Apply clean dry dressing if necessary.
- Treat victim for shock as required.
- Arrange transportation to a hospital as quickly as possible.
- If arms or legs are affected keep them elevated.

4. Unpacking

The package contains:

- 1 **TELINK-SNMP2**
- 1 User Manual
- 1 Mains Power Cable

The following accessories are also available from Your R.V.R. Dealer:

- **Accessories, spare parts and cables**

4.1 General Description

The **TELINK-SNMP2**, manufactured by **R.V.R. Elettronica SpA**, is an **SNMP telemetry interface** via LAN that can be connected to all standard equipment manufactured by RVR.

The **TELINK-SNMP2** have been designed for installation in a 1HE box for 19" rack.

Two major features of **TELINK-SNMP2** are compact design and user-friendliness. Design is based on a modular concept: the different functions are performed by modules that, for the most part, are connected through male and female connectors or through flat cables terminated by connectors. This design facilitates maintenance and module replacement.

The **TELINK-SNMP2** is an interface endowed with a microcomputer and a resident RTOS operating system specialized in the simultaneous management of data passing between 4 serial ports.

The **TELINK-SNMP2** opens the standard telemetry channel of RVR, available on connector DB9 and normally connected to high-level telemetry systems of station like ANTLAN, SNMP.

It also include a Web Server that allows to be connected in ethernet network and to be explored by MIB browser. Supports E-mail messages to report possibly system errors.

The SNMP protocol is managed by a DSP at 120 MHz inside the **TELINK-SNMP2**.

The Web server port can be connected to internet network and through a DNS link, the **TELINK-SNMP2** can be interrogated by an IP address (i.e. 192.168.0.167).

All signals and the power supply are provided with connectors for a quick replacement.

The power supply is galvanically isolated and the signals are filtered to have an high immunity to RF disturbances.

In rear panel there are ten led to a complete synoptic on the serial line traffic and diagnosis on error type.

TELINK-SNMP2 is equipped with watchdog hardware to reset the equipment automatically in case of abnormal stop of processor or in case of lowering below the threshold about power supply voltage.

TELINK-SNMP2 has a “simulation” modality that allows to connect an ANTLAN system regularly to **TELINK-SNMP2** and reading the virtual value (test of the protocol and network).

The rear panel features the mains input connector, as well as the telemetry input connector, the dip-switch for the configuration of the **Main** card and the programming connector both for the **Main** card and for the **SNMP ANTLAN** card.

5. Installation and configuration procedure

This section provides a step-by-step description of equipment installation and configuration procedure. Follow these procedures closely upon first power-on and each time any change is made to general configuration, such as when a new transmission station is added or the equipment is replaced.

Once the desired configuration has been set up, no more settings are required for normal operation; at each power-up (even after an accidental shutdown), the equipment defaults to the parameters set during the initial configuration procedure.

The topics covered in this section are discussed at greater length in the next sections, with detailed descriptions of all hardware and firmware features and capabilities. Please see the relevant sections for additional details.



IMPORTANT: *when configuring and testing the transmitter in which this telemetry unit is integrated, be sure to have the Final Test Table supplied with the equipment ready at hand throughout the whole procedure; the Final Test Table lists all operating parameters as set and tested at the factory.*

5.1 Preparation

5.1.1 Preliminary checks

Unpack the exciter and immediately inspect it for transport damage. Ensure that all connectors are in perfect condition.

Provide for the following (applicable to operating tests and putting into service):

- √ Mains power supply, 230 VAC (-15% / +10%), with adequate earth connection.
- √ Connection cable kit including:
 - Mains power cable;
 - Telemetry signal cable (cable with DB9 connector, not included);
 - Crossover RS232 cable (cable with DB9 connector, not included) for direct connection to PC;
 - Ethernet cable (cable with RJ45 connector, not included) for connection to ADSL router or LAN network;
 - Crossover Ethernet cable (cable with RJ45 connector, not included) for direct connection to PC.

5.1.2 Connections

- 1) Connect the **RS232** output of transmitter to the **RS232** input of the **TELINK-SNMP2** interface, through the RS232 cable.



Note : *If you intend to connect it directly to a PC, it is necessary to use a crossover RS232 cable (i.e. when you need to program the **Main** card). This is a basic prerequisite to ensure equipment correct operation.*

- 2) Connect the **ETHERNET** output of **TELINK-SNMP2** interface to the appropriate input of your ADSL router or LAN network. If the connecting device is different, identify an equivalent.



Note : *If you intend to connect it directly to a PC, it is necessary to use a crossover ethernet cable (i.e. when you need to program the **SNMP ANTLAN** card). This is a basic prerequisite to ensure equipment correct operation.*

- 3) Connect the network cable to the relevant **MAINS VOLTAGE** connector on **TELINK-SNMP2** interface.

5.2 First Power-On and Set-Up

Perform this procedure upon first power-up and each time you make changes to the configuration this component is integrated into.

5.2.1 Web User Interface (WUI)

Once all connections previously described are performed, the equipment is ready for commissioning.

The **WUI** (Web User Interface) allows you to adjust, modify or display the configuration variables such as IP, netmask and gateway address. Follow the procedure below to open the **WUI**:

- 1) Open your web browser on your PC, and connect to ***http://192.168.0.167*** address to connect to the **WUI** (if LAN IP address was previously modified, it is necessary to use the new one). At this point the following page opens.

By factory the RVR uses the following adjustments:

- IP address: **192.168.0.167**
- Netmask address: **255.255.255.0**
- Gateway address: **192.168.0.1**

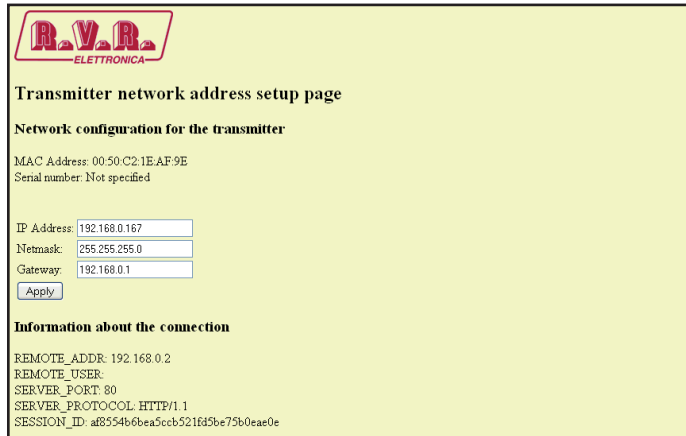

Menu 1



Nota : If address <http://192.168.0.167> does not work, check and set IP address as **192.168.0.XXX** (where XXX is a figure between 0 and 255, excluding 167 that is **TELINK-SNMP2** interface default address). To change the IP address, follow the instructions in the manual or in the online guide and technical help, specific for the Operating System you use.

- 2) Modify the parameters in accordance with the own needs.
- 3) Now interface is ready to remotely read data and modify the various settings of the equipment.

5.2.2 SNMP telemetry

SNMP (Simple Network Management Protocol) is a worldwide protocol that allows the management and supervision of the equipment connected to the network.

Measurements and commands are described by a MIB (Management Information Base), which is a list of OID (Object Identifier). Each OID is a variable that can be written (SET) or read (GET) through a NMS (Network Management System) compatible with SNMP.

The MIB is a text file written in ASN.1 and it is imported from the NMS in order to know what OID can be expected by the AGENT (proxy card, alias SNMP ANTLAN in this case) and how to interpret the information received.

On request, the MIB may be associated with the transmission of e-mail.



Note : The user can not freely distribute the MIB, unless written authorization issued by the manufacturer. The MIB is property of the manufacturer.

The SNMP version used in this application is the v1, and is compatible with all NMS systems.

Here is the list of MIB necessary for equipments of RVR equipments:

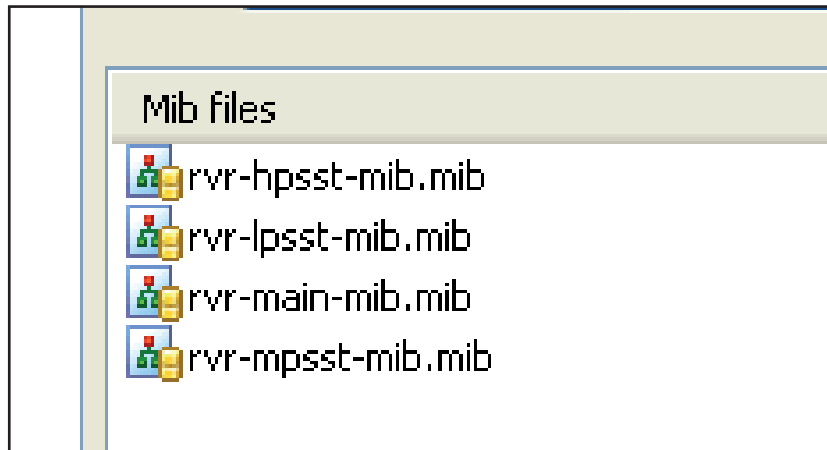

Menu 2

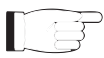

Nota : Use a MIB BROWSER (not included) to use the MIB of RVR equipments. These are usually provided in an accompanying CD with the system in which the **TELINK-SNMP2** is installed.

5.3 Management Firmware

5.3.1 Reading and Settings of Measurement

Each transmitter has a range of measures that can be read. Please refer to MIB for a detailed description of each measurement. The transmitter has an SCI (Serial Communication Interface) owner, that reads and stores the telemetry data in the **Main** card. The **Main** card then sends the data to the **ANTLAN SNMP** card for formatting/analysis which finally export the data obtained as SNMP.

In the following you can find the list of typical measures of transmitter. For simplicity are shown only those related to 10kW transmitter, but the same tree is also used to power different transmitters.



Nota : In the following examples is used a MIB browser of ANTGroup, but any MIB Browser can be used.

The MIB are specified the range and description of each variable, in this case the forward power and possible alarms, which are reported into the description box at the end. If the READ ONLY and MANDATORY conditions are present, they mean that the value is been obtained.

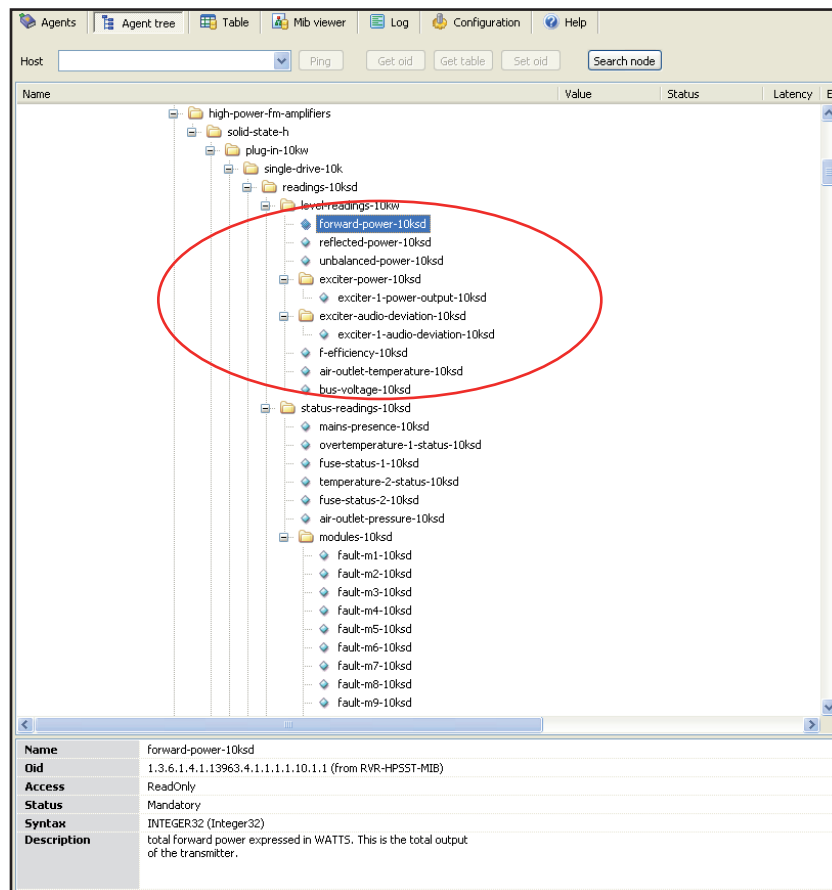

Menu 3

Each input is associated to a tree for alarms settings. The tree for alarms settings (or trap settings) can be found in section 110 of each subtree.

The adjustment of the class is not used in this release. For each analog measurement can be set:

- The maximum value (MAX) is the fixed point beyond which is sent a TRAP.
- The minimum value (MIN) is the fixed point below which is sent a TRAP.
- The hysteresis value is a nominal value that the system adds (or subtracts) to real value in order to exit from alarm condition.
In other words, it is helpful to avoid situations of continuous alarm, if readout is very close to the set point alarm.

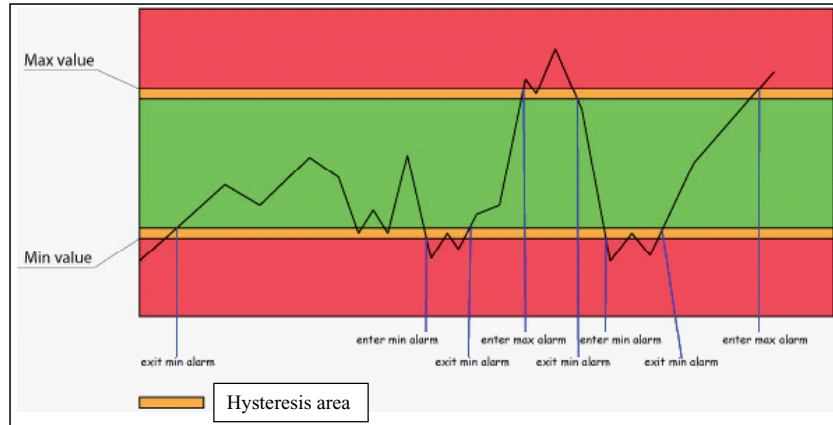

Menu 4

As you can see the hysteresis is a protected area in which the alarm is not sent, when the value exceeds the minimum value (MIN) when there is no alarm or the maximum value (MAX) alarm is active, the minimum value (MIN) alarm is set. To exit the MIN alarm condition, the value should be equal to the MIN value plus the value of hysteresis.



Note : the hysteresis value must be less than $\frac{1}{2}$ referred to distance between the minimum value (MIN) and maximum value (MAX).

An example of an analog alarm setting, are included in the following section in the SNMP tree:

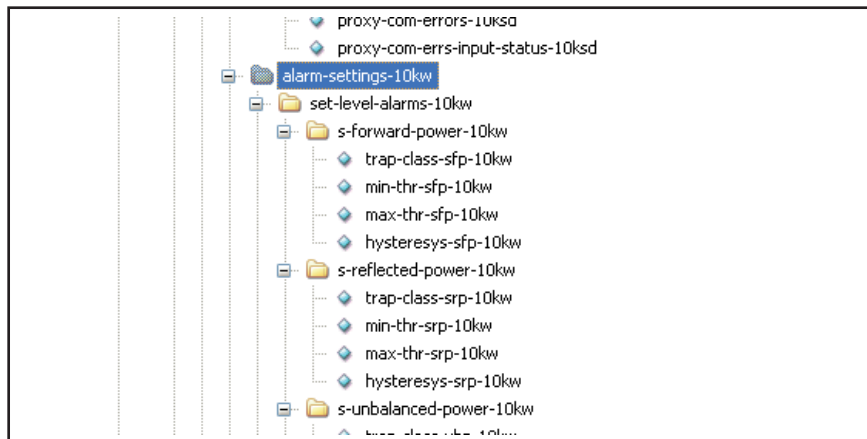

Menu 5

5.3.2 Reading and Settings of Status

Similarly to measurements described in the previous chapter, each transmitter has a range of states that can be read. Please refer to MIB for a detailed description of each measurement. The transmitter has an SCI (Serial Communication Interface) owner, that reads and stores the telemetry data in the **Main** card. The **Main** card then sends the data to the **ANTLAN SNMP** card for formatting/analysis which finally export the data obtained as SNMP.

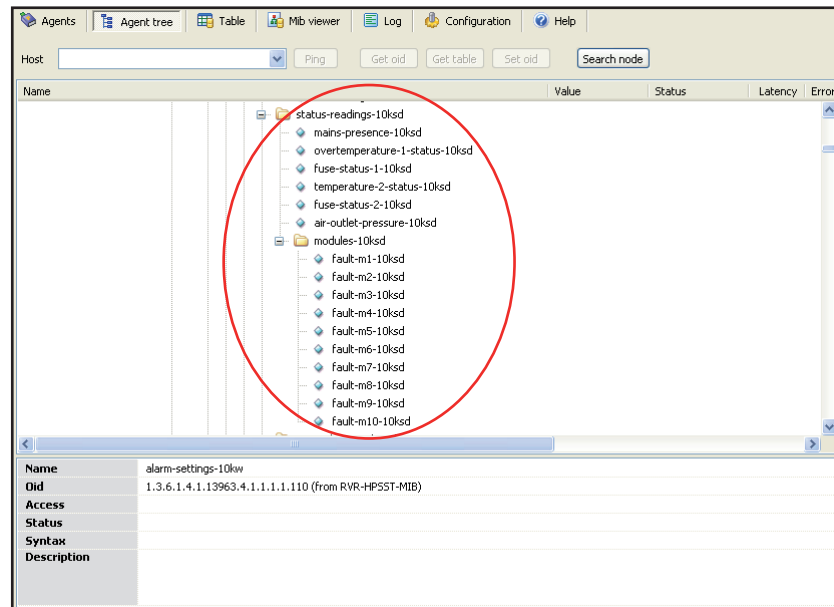

Menu 5

Each input is associated to the tree of alarms settings. Similarly to measurements described in the previous chapter, the structure for alarms settings (or trap settings) can be found in section 110 of each subtree.

For each analog measurement can be set a maximum (MAX) and minimum value (MIN). The adjustment of the class is not used in this release.

For each value state there is a alarm setting group that allows you to:

- Enable/disable the send of TRAP.
- Send TRAP only when the alarm state happens.
- Send TRAP only when the alarm state re-enters .
- Send TRAP when the alarm state happens or re-enters.

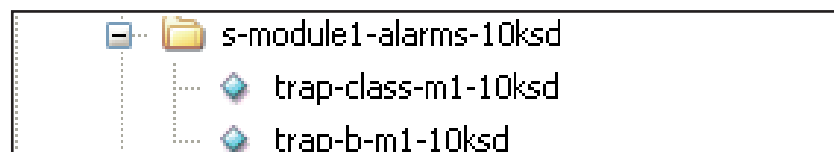

Menu 6

Name	trap-b-m1-10ksd
Oid	1.3.6.1.4.1.13963.4.1.1.1.1.110.2.7.1.2 (from RVR-HPSSST-MIB)
Access	ReadWrite
Status	Mandatory
Syntax	ENUM (Dig-alarm-behav) (1=disable-alarm-sending 2=send-only-on-val-0 3=send-only-on-val-1 4=send-on-every-state-change)
Description	indicates how this trap should work

Menu 7

As you can see from the menus above, the operation mode is adjustable.

5.3.3 TRAP sending

The telemetry system is capable to sending TRAP up to five different addresses. Different addresses can be set using the OID in major MIB, in this case:

- IP address.
- Destination port.

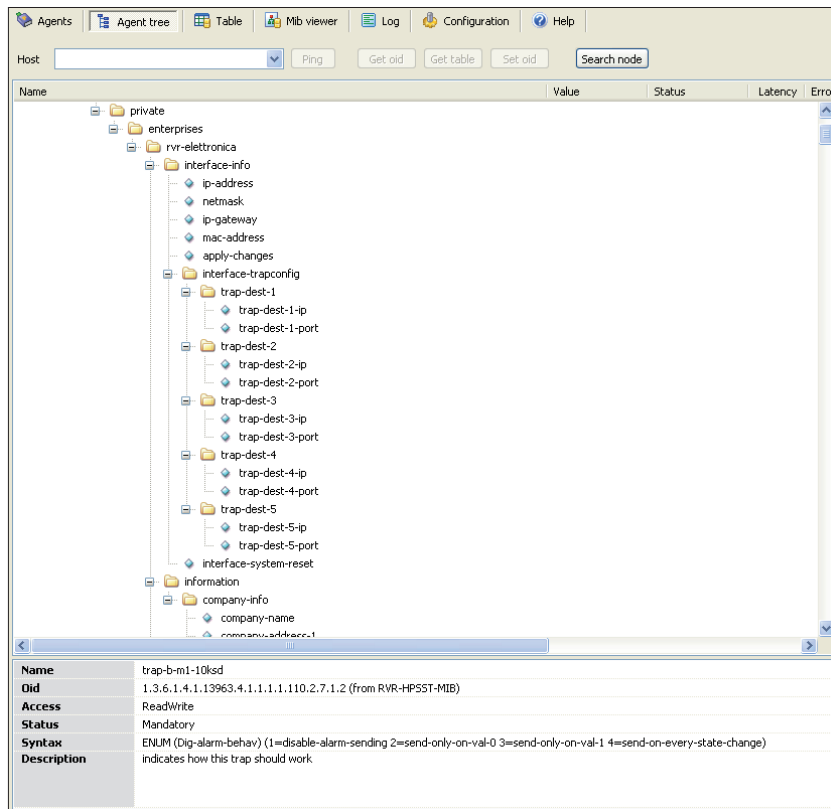

Name	trap-b-m1-10ksd
Oid	1.3.6.1.4.1.13963.4.1.1.1.1.110.2.7.1.2 (from RVR-HPSSST-MIB)
Access	ReadWrite
Status	Mandatory
Syntax	ENUM (Dig-alarm-behav) (1=disable-alarm-sending 2=send-only-on-val-0 3=send-only-on-val-1 4=send-on-every-state-change)
Description	indicates how this trap should work

Menu 8

5.3.4 Commands sending

Similarly to readings and settings of the measurements, the commands have a set of OID that are only in writing mode. For each transmitter, the MIB exports a specific set of OID.

The controls can regulate ON/OFF: to activate (ON) the user must send a “2” as value for the disabled (OFF) the user must send a “1” as value. No other values are accepted as a command.

Usually the commands are one-shot toggle. In other words, if the transmitter is turn “ON” (value “2” to set-transmitter-on-10ksd), the next command is a turn “OFF” (value “2” set-transmitter-off-10ksd) and not a disable “ON” (value “1” to set-transmitter-on-10ksd).

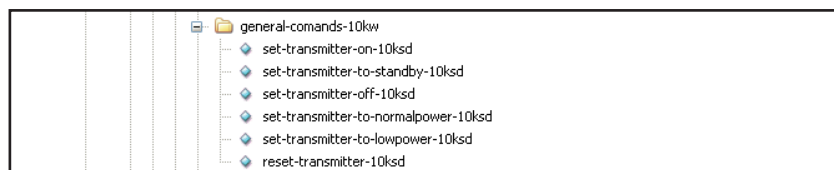

Menu 9

5.3.5 Proxy Serial Communication

There are a set of OID that monitoring the serial communication between the **ANTLAN SNMP** card and the **Main card** equipped inside the telemetry unit.

The user can set the system so that all measures are sent to 0 when the serial communication fails. In this case is also issued a TRAP.

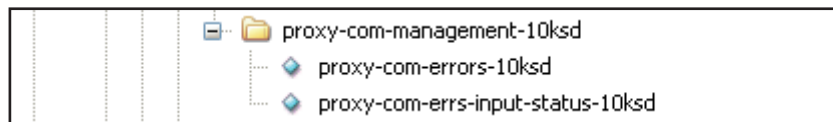

Menù 10

TRAP settings:

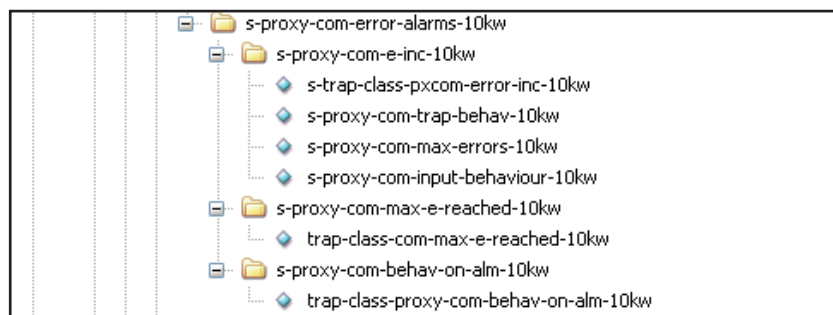

Menù 11

6. External Description

This section describes the components found on the front and rear panel of **TELINK-SNMP2**.

6.1 Front Panel

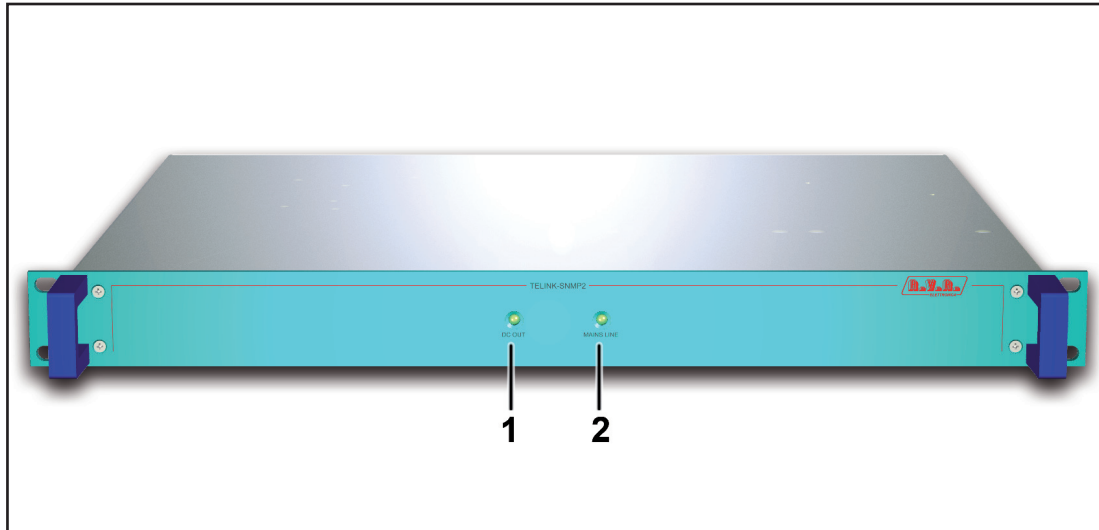

Figure 6.1

- | | |
|----------------|--|
| [1] DC OUT | Green LED - Lit on when the power supply works and cards feed correctly. |
| [2] MAINS LINE | Green LED - Lit on when the telemetry unit is feeded by mains. |

6.2 Rear Panel

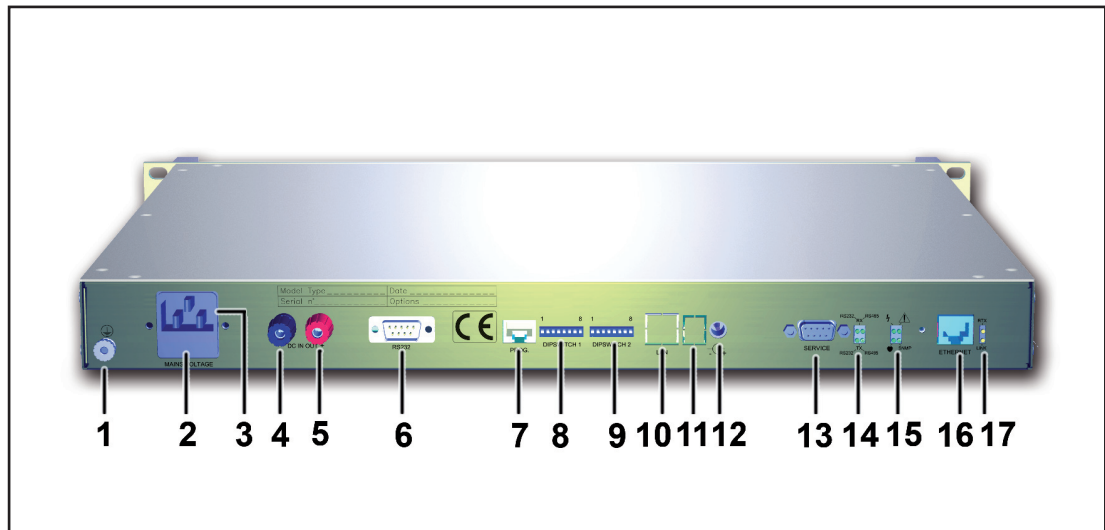

Figure 6.2

[1] GROUND	Ground connection.
[2] FUSE BLOCK	Fuse carrier. Use a screwdriver to access the fuse. Contains two general protection fuses rated 2 A.
[3] PLUG	VDE plug for mains power supply.
[4] 24 VDC IN-	Not used.
[5] 24 VDC IN+	Not used.
[6] RS232	DB9 connector for direct serial communications in RS232 standard with the equipments under telemetry.
[7] PROG.	RJ45 connector for programming of TELINK in RS485 standard (configuration) and firmware upgrade.
[8] DIPSWITCH 1	Dip switch to regulate the TELINK card (for configuration read the TELINK user manual).
[9] DIPSWITCH 2	Dip switch to regulate the TELINK card (for configuration read the TELINK user manual).
[10] LAN	Not used.
[11]	Not used.
[12] DC PLUG	Not used.
[13] SERVICE	DB9 connector for interconnection in RS232 standard with PC for programming and e drivers upload for TANT137 card.
[14] SYNOPTIC 1	LEDs for information about the status of communications in RS232 and RS485 standards (chap. 8.4.2).
[15] SYNOPTIC 2	LEDs for information about the status of the card (chap. 8.4.2).
[16] ETHERNET	RJ45 connector for communication with LAN network.
[17] SYNOPTIC 3	LEDs for information about the status of ETHERNET connector (chap. 8.4.2).

6.3 Connector Description

6.3.1 RS232

Type: DB9 Male

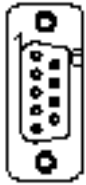

- 1 N.C.
- 2 RxD
- 3 TxD
- 4 N.C.
- 5 GND
- 6 N.C.
- 7 N.C.
- 8 N.C.
- 9 N.C.

6.3.2 SERVICE

Type: DB9 female



- 1 DCD
- 2 RxD
- 3 TxD
- 4 DTR
- 5 GND
- 6 DSR
- 7 RTS
- 8 CTS
- 9 RI

6.3.3 PROG.

Type: RJ45 female

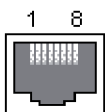

- 1 N.C.
- 2 TxD
- 3 RxD
- 4 DTR
- 5 GND
- 6 +5V_{DC}
- 7 N.C.
- 8 N.C.

6.3.4 ETHERNET

Type: RJ45 female

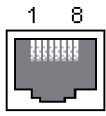

1	TX+
2	TX-
3	RX+
4	N.C.
5	N.C.
6	RX-
7	N.C.
8	N.C.

7. Technical Specifications

<i>Parameters</i>	<i>TELINK-SNMP2</i>
GENERALS	
Primary Power	230 VAC ±15%
Physical Dimensions (W x H x D)	483 x 44 x 300 mm
Weight	4 kg
Environmental working temperature	-10 to + 50 °C
Cooling type	Forced with internal fans
INPUT	
Analog	-
Digital/Analog	-
OUTPUTS	
Relay	-
INTERFACE	
RS232	Yes
RS485	Yes
IIC BUS	-
RJ 45 (LAN)	Yes
STANDARD COMPLIANCE	
Safety	EN60215:1997
EMC	EN 301 489-11 V1.4.1
Spectrum Optimization	-

8. Working Principles

A schematic view of the modules and connections making up the **TELINK-SNMP2** with the telemetry board is shown in figure 8.1.

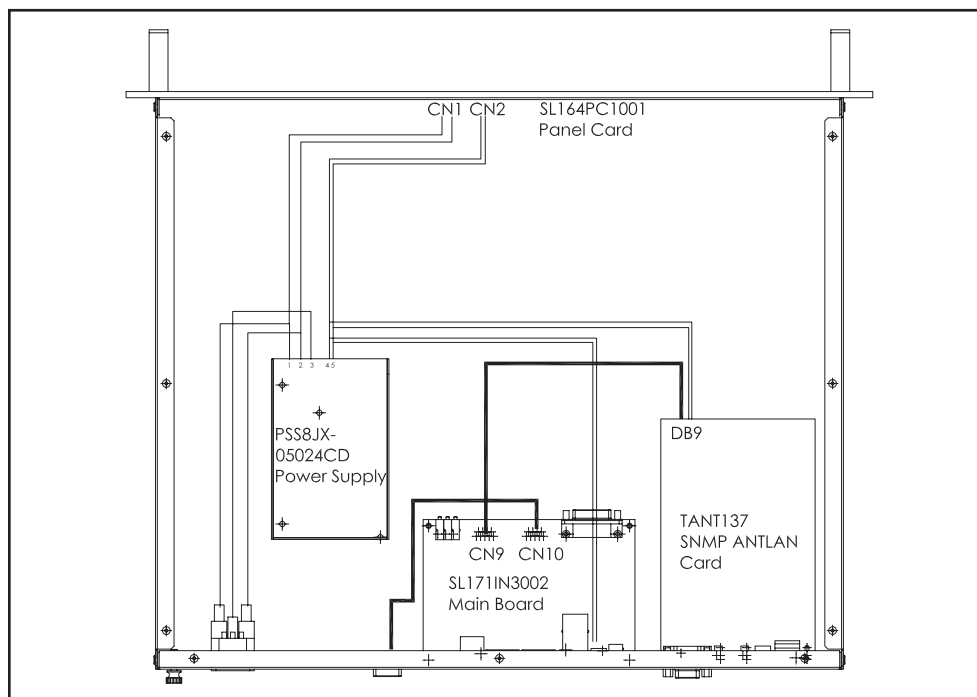

Figure 8.1

A brief description of each module's functions is given below, whereas the complete diagrams and layout of the cards are given in the "Technical Appendix" Vol.2.

8.1 Power Supply

The power supply on this amplifier, provides to RF power module a DC voltage of 24 V with a maximum current of 2,1 A.

It is based on transformer technology at 50/60 Hz, and it is made up of the following components:

- Service fuses
- Service transformer

8.2 Panel Card

The panel card contains elements that are used to interface with the user (LED).

It provides information on the correct power supply of telink **TELINK-SNMP2**.

8.3 Main card

This card is an interface endowed of microcomputer with a RISC microprocessor and a resident RTOS operating system specialized in the simultaneous management of data passing between serial ports.

It also include a Web Server that allows to be connected in ethernet network and explored by a standard browser tlike Explorer or similar (HTML function). The TCP/IP, Telnet, http, SNMP, XML/RSS, HTTPS/SSL/SSH protocols are managed by a DSP at 120 MHz inside the card.

The Web server port can be connected to internet network and through a DNS link, the Main card can be interrogated with a unique name of the station instead of IP address (i.e. from internet radio_rvr_spa.it instead xxx.xxx.xxx.xxx).

More information about use, configuration of Dip-Switches on rear panel and configuration of this card are given in the **TELINK user manual**, while information on use of the Web server are given in chapter 5.2.1.

8.4 SNMP ANTLAN Card

The card converts SNMP (Simple Network Management Protocol) over Ethernet in ANTLAN protocol on RS232 or RS485.

It acts as an SNMP agent executing the translation of all the properties of the serial communication protocol (RS232 or RS485), located on board of equipment, as SNMP. It can make available the data as an OID (Object Identifier) programmable over Ethernet.

The control center displays the data as if it were read on the RS485 port or parallel I/O port.

8.4.1 Dip-Switches Regulation

In the center of the card there is a dip-switch, the informations on the settings of each switch are given below.

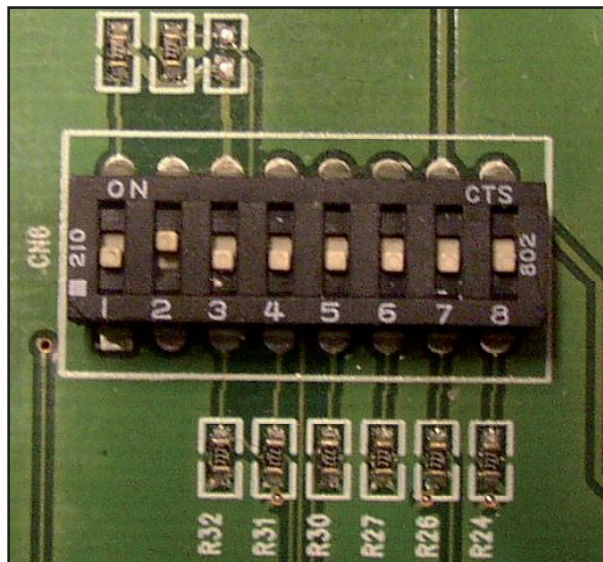

Figure 8.2

1. Always OFF (no change)
2. Always OFF (no change)
3. ON: for software upgrade
OFF: normal operation
4. ON: debug mode
OFF: normal operation
5. ON: dual exciter transmitter
OFF: single exciter transmitter
- 6&7. 6:OFF 7: OFF 10kW transmitter
6:ON 7: OFF 5kW transmitter
6:ON 7: OFF 2kW transmitter
8. Reserved for future use

8.4.2 Synoptics LED Identification

On the back of the card, visible from rear panel, are located 2 synoptics LED panels. Information is available below.

- SYNOPTIC 1 (note [14] - fig. 6.2)

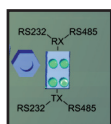

- | | |
|----------|---|
| RX RS232 | Green Led - Blinks during data reception in RS232 standard on SERVICE connector. |
| RX RS485 | Green Led - Blinks during data reception in RS485 standard on SERVICE connector. |
| TX RS232 | Green Led - Blinks during data transmission in RS232 standard on SERVICE connector. |
| TX RS485 | Green Led - Blinks during data transmission in RS485 standard on SERVICE connector. |

- SYNOPTIC 2 (note [15] - fig. 6.2)

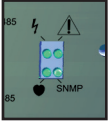

Green Led - Lit on identifies the correct feeding of card.

Green Led - Lit on indentifies malfunctions on hardware.

Green Led - Blink identifies the proper functioning of watchdog on card.

SNMP

Green Led - Blink during a SNMP interrogation ended successfully.

- SYNOPTIC 3 (note [17] - fig. 6.2)



RTX

Yellow Led - Blinks during data reception on ETHERNET connector.

LINK

Yellow Led - Blinks during data transmission on ETHERNET connector.

9. Identification and Access to the Modules

The **TELINK-SNMP2** is made up of various modules linked to each other through connectors so as to make maintenance and any required module replacement easier.

9.1 Upper View

The figure below shows the equipment upper view with the various components pointed out.

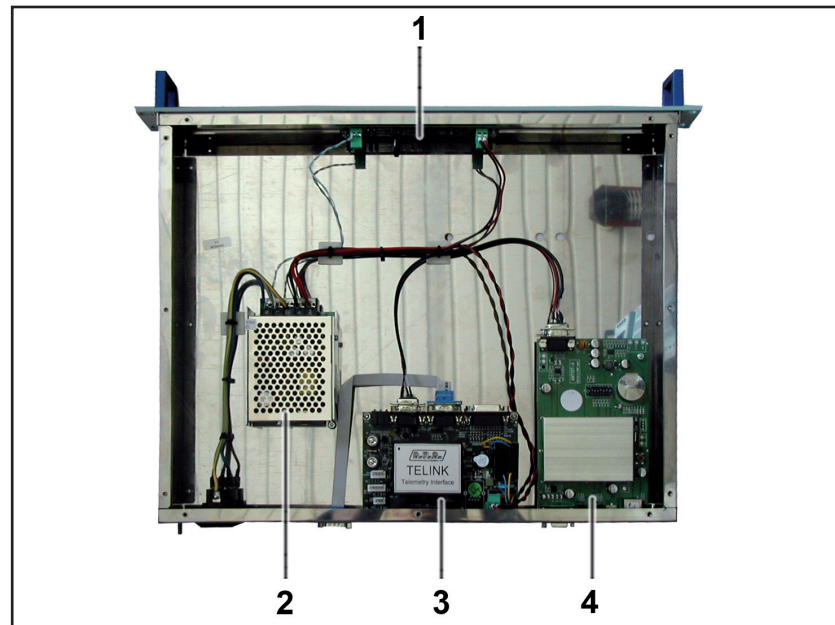

Figure 9.1

- [1] Panel Card (SL164PC1001)
- [2] Power Supply (PSS8JX-05024CD)
- [3] Main Card (SL171IN3002)
- [4] SNMP ANTLAN Card (TANT137)

This page was intentionally left blank