

TLC300

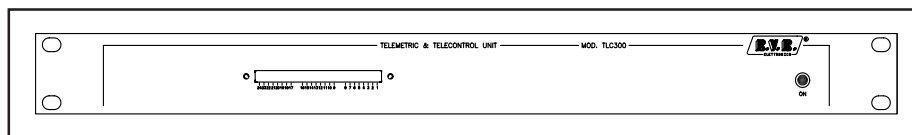

User Manual

Manufactured by



Italy



File name: TLC300_EN.p65

Version: 1.0

Date: 07/04/2003

Revision History

Version	Date	Reason	Editor
1.0	07/04//2003	New version	J. Berti

TLC300 - User Manual
Version 1.0

© Copyright 2003
R.V.R. Elettronica SpA
Via del Fonditore 2/2c - 40138 - Bologna (Italia)
Telefono: +39 051 6010506
Fax: +39 051 6011104
Email: info@rvr.it
Web: www.rvr.it

All rights reserved

Printed and bound in Italy. No part of this manual may be reproduced, memorized or transmitted in any form or by any means, electronic or mechanic, including photocopying, recording or by any information storage and retrieval system, without written permission of the copyright owner.

Table of content

1. Preliminary Instructions	1
2. Warranty	3
3. First Aid	5
3.1 Treatment of electrical shocks	5
3.2 Treatment of electrical Burns	6
4. General Information	7
4.1 Configuration	8
5. Quick reference	11
5.1 Quick reference of TLC system	11
6. System Status Enquiries	15
6.1 Local enquiries	15
6.2 Remote enquiries with remote control software	15
6.3 Remote enquiries with GSM modem + SMS	15
7. External Features	17
7.1 TLC300 description	17
7.2 Change over card	19
7.3 Additional Standard Telemetry Card	23
7.4 Description of service connectors PIN	25
8. Identification and Access to modules	27
8.1 CPU card	27
8.2 Panel card	27
8.3 Telemetry card	28
8.4 Relay control card	29
8.5 Power supply	29
9. Card settings	31
9.1 Setting of the card internal address	31
9.2 Setting of the Dip-Switches	32
10. Test Board Description	37
10.1 The board	37
10.2 The meant of the clips	37
10.3 Digital/Analog Input	38
10.4 Rly Output	39
10.5 Connection to TLC	40
10.6 How to make the tests	40

This page was intentionally left blank

1. Preliminary Instructions

This manual is written as a general guide for those having previous knowledge and experience with this kind of equipment, well conscious of the risks connected with the operation of electrical equipment.

It is not intended to contain a complete statement of all safety rules which should be observed by personnel in using this or other electronic equipment.

The installation, use and maintenance of this piece of equipment involve risks both for the personnel performing them and for the device itself, that shall be used only by trained personnel.

R.V.R. Elettronica SpA doesn't assume responsibility for injury or damage resulting from improper procedures or practices by untrained/unqualified personnel in the handling of this unit.

Please observe all local codes and fire protection standards in the operations of this unit.



WARNING: always disconnect power before opening covers or removing any part of this unit.

Use appropriate grounding procedures to short out capacitors and high voltage points before servicing.



WARNING: this device can irradiate radio frequency waves, and if it's not installed following the instructions contained in the manual and local regulations it could generate interferences in radio communications.

This is a "CLASS A" equipment. In a residential place this equipment can cause hash. In this case can be requested to user to take the necessary measures.

R.V.R. Elettronica SpA reserves the right to modify the design and/or the technical specifications of the product and this manual without notice.

This page was intentionally left blank

2. Warranty

Any product of **R.V.R. Elettronica** is covered by a 24 (twenty-four) month warranty.

For components like tubes for power amplifiers, the original manufacturer's warranty applies.

R.V.R. Elettronica SpA extends to the original end-user purchaser all manufacturers warranties which are transferrable and all claims are to be made directly to R.V.R. per indicated procedures.

Warranty shall not include:

- 1 damages taken place during the shipment of the machine to the R.V.R. for eventual repairs;
- 2 Any unauthorized repair/modification;
- 3 Incidental/consequential damages as a result of any defect
- 4 Nominal non-incidentals defects
- 5 Re-shipment costs or insurance of the unit or replacement units/parts

Any damage to the goods must be reported to the carrier in writing on the shipment receipt.

Any discrepancy or damage discovered subsequent to delivery, shall be reported to **R.V.R. Elettronica** within **5** (five) days from delivery date.

To claim your rights under this warranty, you should follow this procedure:

- 1 Contact the dealer or distributor where you purchased the unit. Describe the problem and, so that a possible easy solution can be detected.

Dealers and Distributors are supplied with all the information about problems that may occur and usually they can repair the unit quicker than what the manufacturer could do. Very often installing errors are discovered by dealers.

- 2 If your dealer cannot help you, contact **R.V.R. Elettronica** and explain the problem. If it is decided to return the unit to the factory, **R.V.R. Elettronica** will mail you a regular authorization with all the necessary instructions to send back the goods.
- 3 When you receive the authorization, you can return the unit. Pack it carefully for the shipment, preferably using the original packing and seal the package perfectly. The customer always assumes the risks of loss (i.e., R.V.R. is never responsible for damage or loss), until the package reaches R.V.R. premises. For this reason, we suggest you to insure the goods for the whole value. Shipment must be effected C.I.F. (PREPAID) to the address specified by R.V.R.'s service manager on the authorization



DO NOT RETURN UNITS WITHOUT OUR AUTHORIZATION AS THEY WILL BE REFUSED

- 4 Be sure to enclose a written technical report where mention all the problems found and a copy of your original invoice establishing the starting date of the warranty.

Replacement and warranty parts may be ordered from the following address. Be sure to include the equipment model and serial number as well as part description and part number.



R.V.R. Elettronica SpA
Via del Fonditore, 2/2c
40138 BOLOGNA
ITALY
Tel. +39 51 6010506

3. First Aid

The personnel employed in the installation, use and maintenance of the device, shall be familiar with theory and practice of first aid..

3.1 Treatment of electrical shocks

3.1.1 If the victim is not responsive

Follow the A-B-C's of basic life support

- Place victim flat on his back on a hard surface.
- Open airway: lift up neck, push forehead back (Fig. 3-1).
- clear out mouth if necessary and observe for breathing
- if not breathing, begin artificial breathing (Figure 3-2): tilt head, pinch nostrils, make airtight seal, four quick full breaths. Remember mouth to mouth resuscitation must be commenced as soon as possible

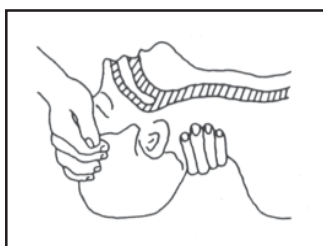

Figure 3-1

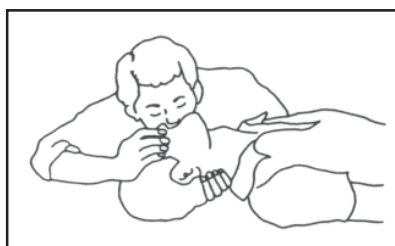

Figure 3-2

- Check carotid pulse (Fig 3-3); if pulse is absent, begin artificial circulation (Fig. 3-4) depressing sternum (Fig. 3-5)

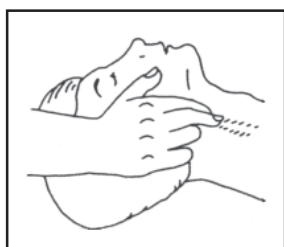

Figure 3-3

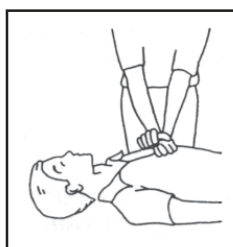

Figure 3-4

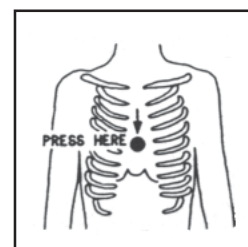

Figure 3-5

- In case of only one rescuer, 15 compressions alternated to two breaths.
- If there are two rescuers, the rythm shall be of one brath each 5 compressions.
- Do not interrupt the rythm of compressions when the second person is giving breath.
- Call for medical assistance as soon as possible

3.1.2 If victim is responsive

- Keep them warm
- Keep them as quiet as possible
- Loosen their clothing (a reclining position is recommended)
- Call for medical help as soon as possible

3.2 Treatment of electrical Burns

3.2.1 Extensive burned and broken skin

- Cover area with clean sheet or cloth
- Do not break blisters, remove tissue, remove adhered particles of clothing, or apply any salve or ointment.
- Treat victim for shock as required.
- Arrange transportation to a hospital as quickly as possible.
- If arms or legs are affected keep them elevated

If medical help will not be available within an hour and the victim is conscious and not vomiting, give him a weak solution of salt and soda: 1 level teaspoonful of salt and 1/2 level teaspoonful of baking soda to each quart of water (neither hot or cold). Allow victim to sip slowly about 4 ounces (half a glass) over a period of 15 minutes. Discontinue fluid if vomiting occurs



DO NOT give alcohol

3.2.2 Less severe burns

- Apply cool (not ice cold) compresses using the cleansed available cloth article.
- Do not break blisters, remove tissue, remove adhered particles of clothing, or apply salve or ointment.
- Apply clean dry dressing if necessary.
- Treat victim for shock as required.
- Arrange transportation to a hospital as quickly as possible
- If arms or legs are affected keep them elevated.

4. General Information

The devices of which the SCM-TLC system consists are all made in 19" 2U rack containers, with the exception of the TLC300, which is 19" 1U size.

Entirely assembled with modules fitted on the base of the device and connected with snap-in fitting connectors, they are easily removed, substituted and added.

On the front panel is a clear graphical user interface which allows you to read and set the operating parameters; the entire system can be controlled using a simple knob (encoder).

On the front panel there is also a set of LEDs, again depending on the preset configuration, which show system status at a glance.

On the rear panel are all of the connectors to be used for connecting the device to the various station components.

The SCM-TLC automatic change over and telemetry system and relative management software were designed to solve all of those problems arising from the management of radio stations located in areas that are not easily reached or which would require a significant amount of time for the operator to reach.

The system has the following main functions:

- management of several radio stations by remote connection with a data-phone modem;
- telemetrization of all operating parameters of the devices present in each station;
- storage in the memory of events which caused faults;
- automatic change over in "1+1" or "N+1" radio transmission systems.

This system allows remote management of the radio station, allowing the operator to intervene immediately in the event of a fault.

The great flexibility of the SCM-TLC system allows an increase in the number of devices controlled or modification of the station layout at any time, without necessitating radical changes in the management system, but simply adding expansion cards which allow an increase in the number of operating parameters that can be managed.

The SCM-TLC system was designed to operate at its best with all R.V.R. devices, but can also function with devices not made by R.V.R., provided that they make the main operating parameters available externally by means of analog signals with values between 0 and +5V.

The management software has a user friendly interface and can be managed using any personal computer with the WINDOWS™ environment.

4.1 Configuration

The SCM-TLC system has two main types of operation, within which there may be various versions, depending on the number of data acquisition cards fitted: automatic change over (1+1 or N+1) and telemetry, or just telemetry.

4.1.1 Automatic change over and telemetry

Two types of devices control this type of operation:

- SCM 1+1-LCD: automatic change over between the main transmitter and a stand-by transmitter; supports up to 3 additional telemetry cards for a total of 30 balanced analog inputs, 58 digital/analog inputs and 24 relay outputs.
- SCM 4+1-LCD: automatic change over among several main transmitters (up to 4) and a stand-by transmitter, automatically configured to substitute the transmitter affected by the fault (the stand-by must have an external control for setting the operating frequency); supports up to 2 additional telemetry cards, for a total of 27 balanced analog inputs, 52 unbalanced digital/analog inputs and 16 relay outputs.

4.1.2 Telemetry

Two devices are available for station telemetry, depending on complexity and the number of parameters to be acquired:

- TLC300: includes 2 telemetry cards, for a total of 16 balanced analog inputs, 32 digital/analog inputs and 16 relay outputs.
- TLC2000: supports up to 6 additional telemetry cards, for a total of 48 balanced analog inputs, 96 unbalanced digital/analog inputs and 48 relay outputs.

The table below summarizes all possible SCM-TLC system configurations.

Device	Type	Version	bal. IN	dig./an. IN	OUT rly
SCM1-LCD	SCM 1+1 & TLM	T0	6	10	0
SCM1-LCD	SCM 1+1 & TLM	T1	14	26	8
SCM1-LCD	SCM 1+1 & TLM	T2	22	42	16
SCM1-LCD	SCM 1+1 & TLM	T3	30	58	24
SCM4/1-LCD	SCM N+1 & TLM	T0	11	20	0
SCM4/1-LCD	SCM N+1 & TLM	T1	19	36	8
SCM4/1-LCD	SCM N+1 & TLM	T2	27	52	16
TLC300	TLM	T1	8	16	8
TLC300	TLM	T2	16	32	16
TLC2000	TLM	T0 (*)	0	0	0
TLC2000	TLM	T1	8	16	8
TLC2000	TLM	T2	16	32	16
TLC2000	TLM	T3	24	48	24
TLC2000	TLM	T4	32	64	32
TLC2000	TLM	T5	40	80	40
TLC2000	TLM	T6	48	96	48

(*) External communications management only.



The version's name depends on the number of additional telemetry cards and is indicated by the number after the "T" (e.g.: T0 indicates that there are no telemetry cards, T1 indicates that one additional telemetry card is fitted and so on).

SCM1+1 \T0

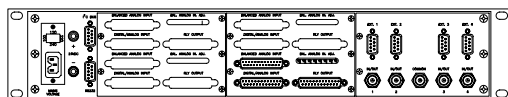

SCM1+1 \T1

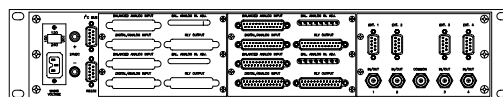

SCM1+1 \T2

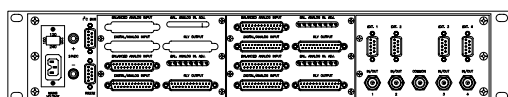

SCM1+1 \T3

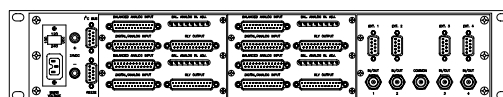

SCM4+1 \T0

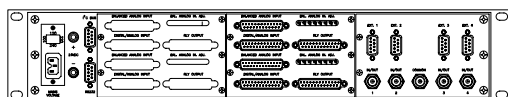

SCM4+1 \T1

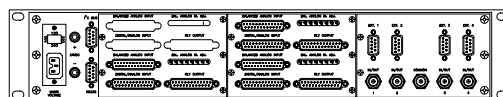

SCM4+1 \T2

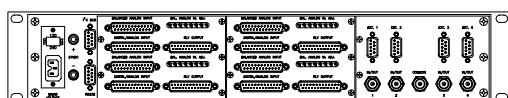

TLC2000 \T0

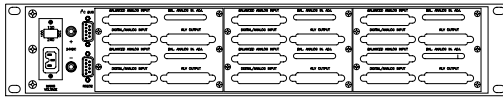

TLC2000 \T1

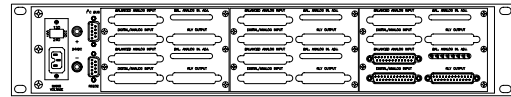

TLC2000 \T2

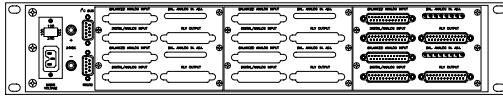

TLC2000 \T3

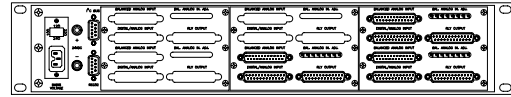

TLC2000 \T4

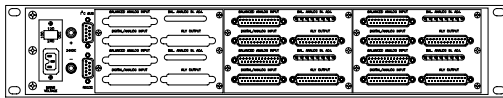

TLC2000 \T5

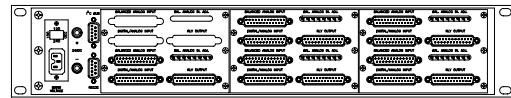

TLC2000 \T6

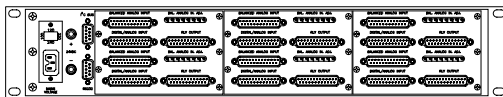

TLC300 \T0



TLC300 \T1



TLC300 \T2

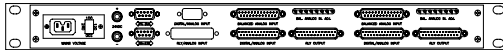

5. Quick reference

The purpose of this chapter is to summarize the points that should be adhered to for using the machines. Should any point not be fully comprehensible, such as how to operate the machine the first time, the description of the operating system should be read very carefully.

5.1 Quick reference of TLC system



5.1.1 Preliminary settings

Before using the equipment with a modem it is necessary to execute some operations:

- Set the DIP-SWITCH (see the table);
 - Modem type absent DIP 1 and 2 OFF;
 - 9600bps serial speed DIP 3 OFF, DIP 4 ON;
 - Address 1 DIP 5 ON.
- Serial connection through Collegamento seriale tramite programma "TELECON" e salvataggio delle impostazioni di configurazione all'interno del TLC.

Description	1	2	3	4	5	6	7	8	1	2	3	4	5	6	7	8	1	2	3	4	5	6	7	8
None																								
PSTN	X																							
PAGER		X																						
GSM	X	X																						
1200																								
2400			X																					
9600				X																				
19200			X	X																				
Address					X	X	X	X	X	X														
Iic board n°											X	X	X	X	X	X								
Generic																								
Pj																	X							
Vj																		X						
0																								
+1																			X					
+2																				X				
+3																			X	X				
+4																					X			
+5																			X		X			
+6																				X	X			
+7																			X	X	X			
D.all.stand																							X	
D.all.gen																								X
Vis.allarm.rel																								X

5.1.2 Alarm condition

In case of an alarm, the TLC limits to the remote and local signalling of the damage found.

5.1.2.1 Alarm type 0

This type of alarm happens on the climb forehead of the voltage present at the input correspondent on the telemetry card, comes therefore generated an alarm message that comes memorized locally and comes subsequently send, through a modem, to the numbers and in the modalities indicated from the carried out programming.

5.1.2.2 Alarm type 1

Analogous this type of alarm happens on the reduction forehead of the voltage present at the input correspondent on the telemetry card, comes therefore generated an alarm message that comes memorized locally and comes subsequently send, through a modem, to the numbers and in the modalities indicated from the carried out programming.

5.1.2.3 Audio signal missing (PTX-LCD only)

The audio signal presence control is carried out only if the exciter of the transmitters is a PTX-LCD series exciter comes, therefore, generated an alarm message that comes memorizzato locally and comes subsequently send through modem to the numbers and in the modalities indicated from the carried out programming.

5.1.2.4 I²C bus alarms

The control on the presence of alarms comes made only in the case is present LCD equipments comes therefore generated a message alarm that comes memorized locally and comes subsequently send through a modem to the numbers and in the modalities indicated from the carried out programming.

5.1.2.5 Default codes

The codes of alarm of default are reassumed in the table.

CODE	Indication	Meant
000	Forward Power	Forward power (analogic read)
001	Reflected Power	Reflected power (analogic read)
$\geq 002 \leq 011$		General alarms adjustable from user
012	Reserved	Reserved
013	No Audio	Absence of audio signal
014	Mod Fault	I2C module damage
015	Restart	System restart

5.1.3 Alarms signalling

The TLC marks the malfunctioning situations in locally and in remote, sending a series of messages with modalities that depend on the modalities indicated in the carried out programming.

5.1.3.1 Local signalling

- If set up, it excites the relay 8 of the Additional card.

5.1.3.2 Remote signalling with telephone modem

- The TLC calls in sequence all the telephone numbers sets up to you and communicates the code and alarm description (from the other part must be connected a PC with the TELECON software in stand-by or a communication program that attended messages from the modem).
- The TLC repeats the series of calls for others many times and for all the numbers indicates to you in the carried out programming.

5.1.3.3 Remote signalling with modem GSM

- The TLC calls in sequence all the telephone numbers memorized in the memory and communicates the code and alarm description (from the other part must be connected a PC with the TELECON software of telecontrollo in stand-by or a program of attended communication in of messages from the modem).
- The TLC sendes the same message in SMS format to the numbers memorized to you through the Serivce Center of GSM manager and repeats the series of calls for others many times and for all the numbers indicates from you in the carried out programming.

6. System Status Enquiries

6.1 Local enquiries

The SCM and TLC2000 devices indicate their status locally and concisely by means of the indicator lights on the front panel. More detailed information can be obtained from the setting and configuration menus.

6.2 Remote enquiries with remote control software

A PC with the Telecon telemetry and remote control software can be used to obtain a very detailed view of all system operating parameters and of all the settings both of the equipment and the devices connected to said equipment.

6.3 Remote enquiries with GSM modem + SMS

Any GSM mobile telephone can be used to query the devices with this system. The device will respond as outlined in the tables in the sections below.

Before querying the system by means of SMS messages, you must be connected by means of the "TELECON" program and set the number of the selected phone Service Center as well as the telephone numbers that can send this type of command to the devices.

6.3.1 List of SMS messages that can be sent to TLC devices

Sent:	Answer:
INFO	TLC ID: 000 Station Name FWD 0% RFL 0% TX ON / TX OFF Audio absent / present Alarm Standard Disable / Alarm General Disable / All Alarm Disable / All Alarm Enable Alarm Present / Alarm Not Present
ALARM	TLC ID: 000 Station Name Lista Allarmi in memoria
TXONn	TLC ID: 000 Station Name TX is ON
TXOFFn	TLC ID: 000 Station Name TX is OFF
OUTONn	TLC ID: 000 Station Name OUT is ON / Out Not Exist
OUTOFFn	TLC ID: 000 Station Name OUT is OFF / Out Not Exist
OUTIMPn	TLC ID: 000 station Name Impulse OK / Out Not Exist
RESETMOD	
RESET	TLC ID: 000 Station Name ALL RESET

This page was intentionally left blank

7. External Features

This chapter describes the components located on the front and rear panels of the SCM-TLC systems.

7.1 TLC300 description

7.1.1 Front panel

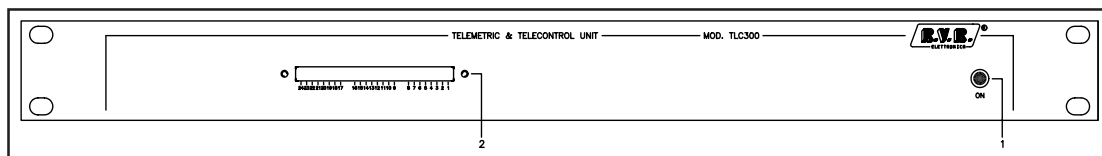

[1] ON

It indicates the operation of the equipment

[2] DIP-SWITCH

It allows the express setting of the present dip-switches

7.1.2 Rear panel

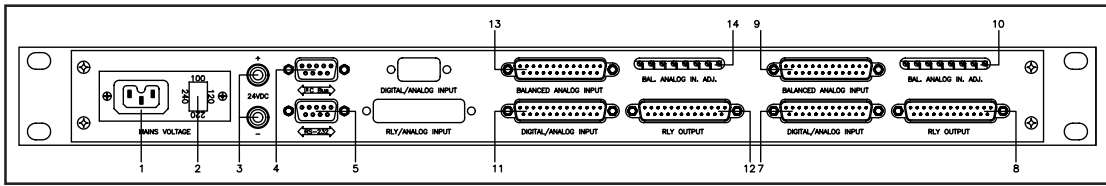

- [1] MAINS VOLTAGE Main connector
- [2] VOLTAGE CHANGER & A.C. LINE FUSE Fuse and voltage changer block. Use a small screwdriver to change the fuse or the mains voltage. Turn the block and position it at the arrow for the required voltage
- [3] 24VDC Socket for 24 Vdc external power supply
- [4] I²C BUS DB9 connector - for communication in I²C standard
- [5] RS-232C DB9 connector for direct communications or via serial modem
- [7] DIGITAL/ANALOG INPUT 1 DB25 input connector - to connect sixteen unbalanced signals: in the case of digital inputs, configure as low active, in the case of analog inputs, the limit voltage is 5V
- [8] RLY OUTPUT 1 DB25 output connector - makes the outputs of eight bistable relay switches available
- [9] BALANCED ANALOG INPUT 1 DB25 input connector - each one is to connect eight balanced analog signals, provided that voltage is between 2 and 12V
- [10] BAL. ANALOG IN. ADJ. 1 Trimmer for adjusting voltage at input of the machine's internal circuitry voltage
- [11] DIGITAL/ANALOG INPUT 2 DB25 input connector - to connect sixteen unbalanced signals: in the case of digital inputs, configure as low active, in the case of analog inputs, the limit voltage is 5V
- [12] RLY OUTPUT 2 DB25 output connector - makes the outputs of eight bistable relay switches available
- [13] BALANCED ANALOG INPUT 2 DB25 input connector - each one is to connect eight balanced analog signals, provided that voltage is between 2 and 12V
- [14] BAL. ANALOG IN. ADJ. 2 Trimmer for adjusting voltage at input of the machine's internal circuitry voltage



NOTE: In figure is represented the rear panel of a TLC300 in T2 version.

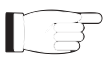

NOTE: The DB25 connectors (7÷9) and the trimmers (10) belong to standard telemetry card n.1, wich is always present, whatever the TLC300 configuration. This card manages the commands, the telemetry operations and standard alarms.

If the parameters to be controlled must be increased, one additional telemetry card is added (11÷14).

7.2 Change over card

These are normal telemetry cards but are used by the managing firmware for controlling the parameters of the change over card which affect machine operations.

Acquires telemetry data in two ways:

- Balanced analog with a limit voltage which can be adjusted between 2V and 12V using a trimmer (eight inputs);
- Unbalanced analog with a limit voltage fixed at 5V, or digital with 2.2 KOhm internal pull-up which can be switched on using a jumper (sixteen inputs).

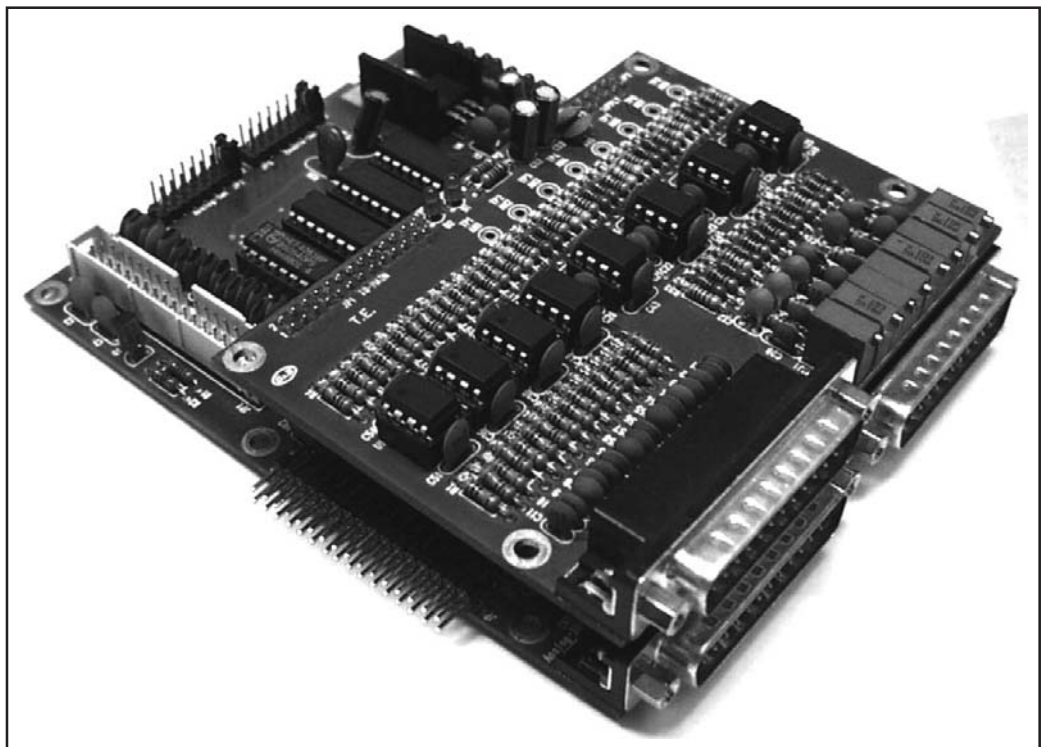

The telemetry card also makes the contacts of eight relay switches available in output (max. 24V - 0.5A).

This is a normal telemetry card, but comes used from the management software of the system for check any basic parameters. The inside address of the card must always be the number 1. Externally is easily recognizable for the connectors DB25 and to the line of trimmers.

7.2.1 Balanced Analog Input

Each of these connectors can be used to connect eight balanced analog signals to the device, as indicated in the table; each input accepts a voltage between 2 and 12V.

The table summarizes the functions to which a few balanced analog inputs of this card are dedicated.

Input from No. 1 to No.4 are used for setting, with the relative trimmer, the level of forward and reflected power of the connected machines.

Pin number	Meant	Adj. Trimmer
2 (+), 14 (-)	Forward power level 1	RV1
3 (+), 16 (-)	Reflected power level 1	RV2
5 (+), 17 (-)	Forward power level 2	RV3
6 (+), 19 (-)	Reflected power level 2	RV4
8 (+), 20 (-)	Forward power level 3	RV5
9 (+), 22 (-)	Reflected power level 3	RV6
11 (+), 23 (-)	Forward power level 4	RV7
12 (+), 25 (-)	Reflected power level 4	RV8
1, 4, 7, 10, 13, 15, 18, 21, 24	GND	

The inputs No.1 and No.2 are used from firmware for the alarms generation of forward and reflected power.

Limit voltages ranging from a minimum of 2V to a maximum of 12V can be applied to the balanced inputs. However, during data processing, the CPU works with a theoretical limit value of 5V. For this reason, there are eight trimmers (RV1-RV8), next to the connector, one for each input, which are used to adjust the limit value set externally to that of the internal circuitry.

To prevent the non-linearity introduced by protective diodes, do not exceed the 4V limit.

The foregoing table shows each balanced input with the relative adjustment trimmer.

7.2.2 Digital/Analog Input

The meaning of these inputs change in according to the type of system to telemetry.

7.2.3 Rly Output

This connector makes the contacts of 8 bistable relay switches available in output. The figure shows a diagram of the relay home or Off position.

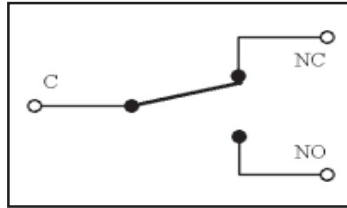

The maximum current which can be passed through the contacts is 500mA at 24V.

The contacts of the relay switches of this connector are used to command the switching on and off of TXs.

The commands to switch on or off for the **EXC**iters , and for the **Power Amplifiers** are given in different way. In On/Off mode the command acts on two particular inputs of the power amplifier (one for the On and one for the Off) closing for approx. 0.5 seconds two contacts of the shunter.

Pin number	Relay	On/Off Mode
1 (C), 14 (NC), 2 (NO)	1	TX On
15 (C), 3 (NC), 16 (NO)	2	TX Off
4 (C), 17 (NC), 5 (NO)	3	1 On
18 (C), 6 (NC), 19 (NO)	4	1 Off
7 (C), 20 (NC), 8 (NO)	5	2 On
21 (C), 9 (NC), 22 (NO)	6	2 Off
10 (C), 23 (NC), 11 (NO)	7	3 On
24 (C), 12 (NC), 25 (NO)	8	3 Off
13		GND

7.2.4 Description of connectors reserved PINs

This section deals with the connectors used by the device for the change over operations.

7.2.4.1 Balanced analog input 1 (Connector [6])

Type: DB25 female

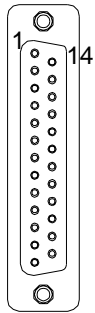

- 1 GND
- 2 Forward power level (+)
- 3 Reflected power level (+)
- 4 GND
- 5 Available input (+)
- 6 Spare Input (+)
- 7 GND
- 8 Spare Input (+)
- 9 Spare Input (+)
- 10 GND
- 11 Spare Input (+)
- 12 Spare Input (+)
- 13 GND
- 14 GND Forward power level (- o GND)
- 15 GND
- 16 GND Reflected power level (- o GND)
- 17 Spare Input (-)
- 18 GND
- 19 Spare Input (-)
- 20 Ingresso disponibile (-)
- 21 GND
- 22 Spare Input (-)
- 23 Spare Input (-)
- 24 GND
- 25 Spare Input (-)

7.3 Additional Standard Telemetry Card

This is a normal telemetry card, but the system management software uses it to control other parameters. The card internal address must always be the last one of the chain.

7.3.1 Balanced Analog Input

The balanced analog inputs of this special card are all available by connecting the signals as indicated in the specific chapter.

7.3.2 Digital/analog Input

The unbalanced digital/analog inputs of this special card are all available by connecting the signals as indicated in the specific chapter.

Pin number	Meant	Jumper on JP4
2	Name and type adjustable through PC	pos. 1
15	Name and type adjustable through PC	pos. 2
3	Name and type adjustable through PC	pos. 3
16	Name and type adjustable through PC	pos. 4
4	Name and type adjustable through PC	pos. 5
17	Name and type adjustable through PC	pos. 6
5	Name and type adjustable through PC	pos. 7
18	Name and type adjustable through PC	pos. 8
21	Name and type adjustable through PC	pos. 9
9	Name and type adjustable through PC	pos. 10
22	Available	pos. 11
10	Available	pos. 12
23	Available	pos. 13
11	Available	pos. 14
24	Available	pos. 15
12	Available	pos. 16
1, 6, 7, 8, 13, 14, 19, 20, 25	GND	

The jumper on JP4 must always be inserted at the corresponding position.

7.3.3 Rly output

All of the contacts of the relay switches of this connector are available and work in 3 ways:

- Generic: it switches to On and Off status statically.
- ToggleOff: always Off and switches to On for a short length of time.
- ToggleOn; always On and switches to Off for a short length of time.

Pin number	Relay	Mode
1 (C), 14 (NC), 2 (NO)	1	Adjustable through PC
15 (C), 3 (NC), 16 (NO)	2	Adjustable through PC
4 (C), 17 (NC), 5 (NO)	3	Adjustable through PC
18 (C), 6 (NC), 19 (NO)	4	Adjustable through PC
7 (C), 20 (NC), 8 (NO)	5	Adjustable through PC
21 (C), 9 (NC), 22 (NO)	6	Adjustable through PC
10 (C), 23 (NC), 11 (NO)	7	Adjustable through PC
24 (C), 12 (NC), 25 (NO)	8	Adjustable through PC
13		GND

7.3.5 Description of general alarms connector PIN

This section deals with the connector used by the device for the triggering of the general RVR alarms (settable via the "TELECON" program).

This connector refers to the last telemetry card inside the machine.

7.3.5.1 Digital/analog input

Type: DB25 female

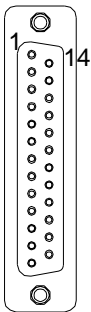

1	GND
2	Alarm custom 1 "MAINS" (jumper pos.1 inserted on telemetry card)
3	Alarm custom 3 "AUDIO EXT" (jumper pos.3 inserted on telemetry card)
4	Alarm custom 5 "CONT GROU" (jumper pos.5 inserted on telemetry card)
5	Alarm custom 7 "OPEN" (jumper pos.7 inserted on telemetry card)
6	GND
7	GND
8	GND
9	Alarm custom 10 "ALARM 12" (jumper pos.10 inserted on telemetry card)
10	Spare Input
11	Spare Input
12	Spare Input
13	GND
14	GND
15	Alarm custom 2 "USER" (jumper pos.2 inserted on telemetry card)
16	Alarm custom 4 "LINK SAT" (jumper pos.4 inserted on telemetry card)
17	Alarm custom 6 "FUEL" (jumper pos.6 inserted on telemetry card)
18	Alarm custom 8 "ALARM 10" (jumper pos.10 inserted on telemetry card)
19	GND
20	GND
21	Alarm custom 9 "ALARM 11" (jumper pos.9 inserted on telemetry card)
22	Spare Input
23	Spare Input
24	Spare Input
25	GND

7.4 Description of service connectors PIN

7.4.1 RS232 Interface

The DB9 connector in question is the SCM and TLC communications port through which the system is controlled remotely.

The meaning of the signals present at the pins is immediate. Notice that the CTS is not managed, in the sense that it is always active.

Type: DB9 female

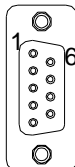
	1	N.C.
	2	TX_D
	3	RX_D
	4	N.C.
	5	GND
	6	+15V
	7	N.C.
	8	CTS
	9	N.C.

7.4.2 I²C Interface

The I²C bus serial interface is used to transfer data between the SCM, the PTX-LCD series exciters, the TLC telemetry system and the PJ-LCD amplifiers.

Pin 2 carries the data (Serial DAta), pin 3 the sampling clock (Serial CLock).

Pin 4 is a device external reset input (low active).

Type: DB9 female

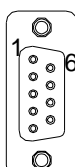
	1	GND
	2	SDA
	3	SCL
	4	External Reset
	5	GND
	6	N.C.
	7	N.C.
	8	N.C.
	9	N.C.

This page was intentionally left blank

8. Identification and Access to modules

8.1 CPU card

The heart of the device is the CPU card, which manages and processes all data from the telemetry cards and the relay control card, as well as data from the devices connected via the I2C bus serial interface.

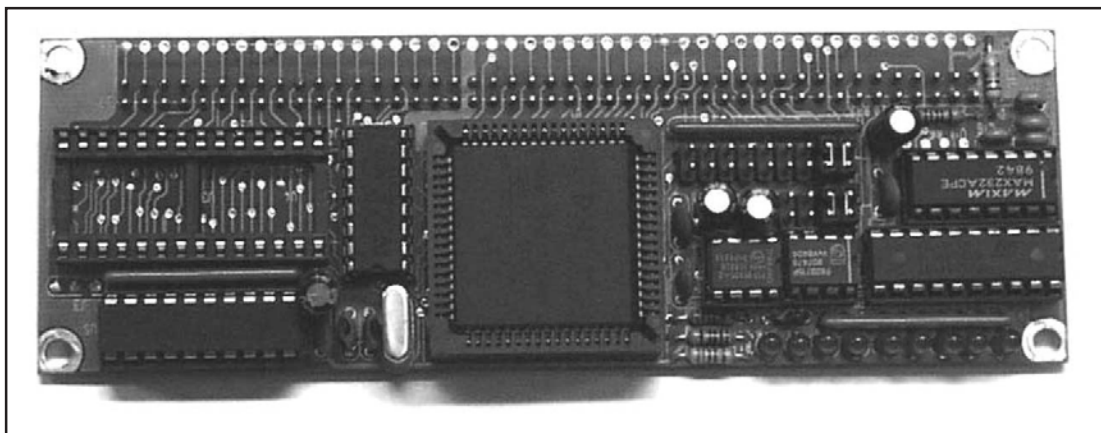

Another important function is the management of the graphical interface, which makes setting and execution of the various operations on the system particularly easy.

8.2 Panel card

This card is fitted with all the connectors in which to insert the CPU card, the connector that carries data and power supply to the telemetry cards and the communications connectors.

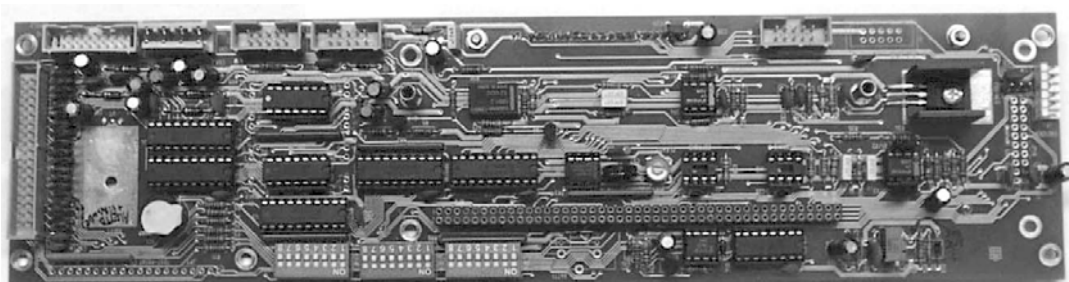

Includes a liquid crystal graphics display, the encoder and several LEDs. This card is not present in model TLC300.

8.3 Telemetry card

Acquires telemetry data in two ways:

- balanced analog with a limit voltage which can be adjusted between 2V and 12V using a trimmer (eight inputs);
- unbalanced analog with a limit voltage fixed at 5V, or digital with 2.2 KOhm internal pull-up which can be switched on using a jumper (sixteen inputs).

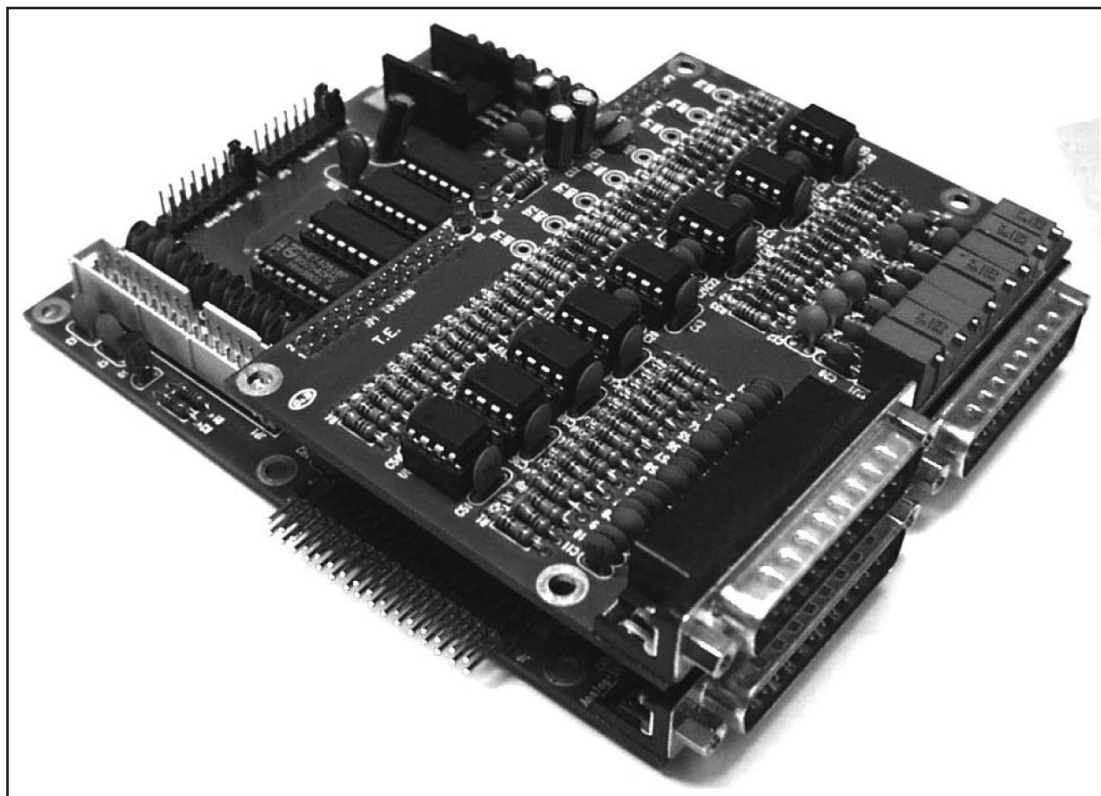

The telemetry card also makes the contacts of eight relay switches available in output (max. 24V - 0.5A).

8.4 Relay control card

Controls automatic change over operations:

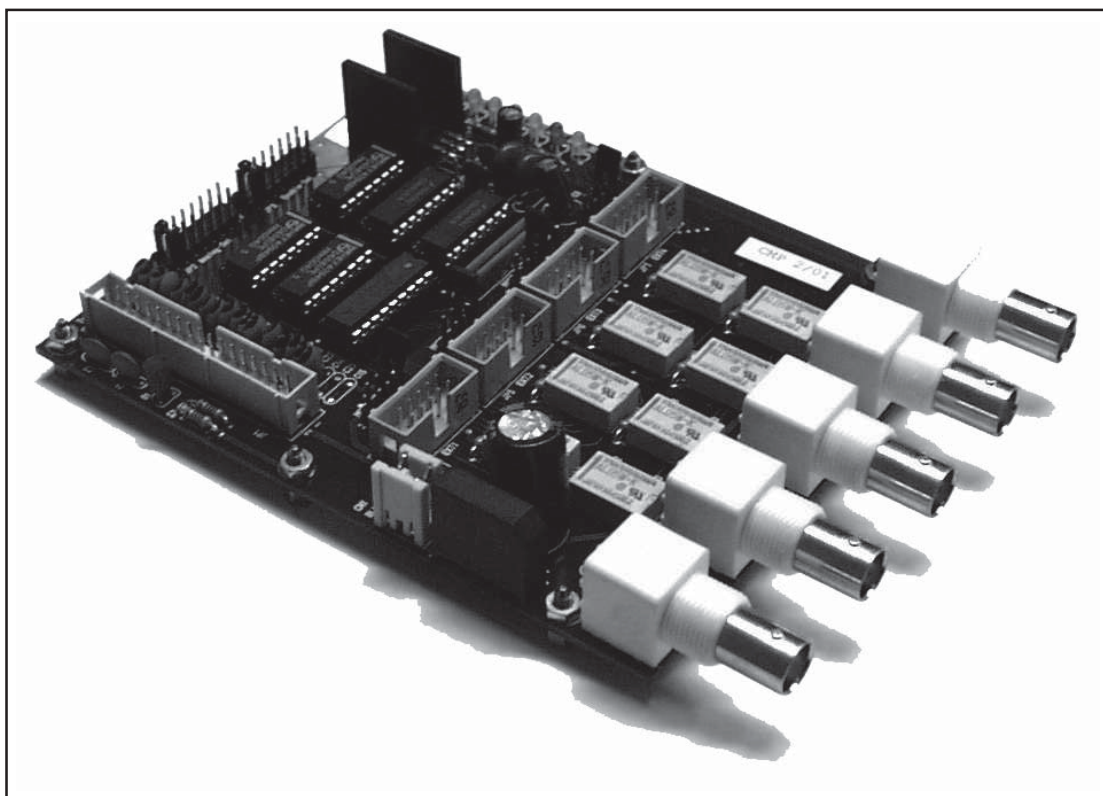

- by controlling in various ways ($\pm 12V$ DC, $\pm 24V$ DC, free switch) up to four coaxial relays and supervising their movements (3 digital inputs for each relay: limit switch position 1, limit switch position 2 and relay in movement);
- by switching the audio signal through five BNC connectors, connected as 4-position switches and one common connector.

This type of card is not present in the devices for telemetry only (TLC300 and TLC2000).

8.5 Power supply

Alternating current with mains voltage 100-120-220-240V which can be selected externally, or 24V direct current.

The power supply unit which powers the various cards in the device is of the switching type.

Models SCM1+1 and SCMN+1 also have a terminal board for selection of the coaxial relay control voltage (12V or 24V).

This page was intentionally left blank

9. Card settings

9.1 Setting of the card internal address

A unique address must be assigned to each card, whether relay control or telemetry, which characterizes it and makes it unique for the CPU. Therefore insert a jumper on each of the JP2 and JP3 connectors in the position indicated in the table below.

Address	jumper on JP2	jumper on JP3	Board type
1	1-2	1-2	Base Telemetry
2	3-4	3-4	Base Telemetry
3	5-6	5-6	Telemetry
4	7-8	7-8	Telemetry
5	9-10	9-10	Telemetry
6	11-12	11-12	Telemetry
7	13-14	13-14	Relais command
8	15-16	15-16	Relais command

Keep in mind that:

- a fixed address interval is assigned to every type of card;
- addresses 1 and 2 are reserved to standard telemetry cards No. 1 and No. 2, respectively;
- address 7 is reserved to the relay control card;
- always assign the lowest free address for each type.

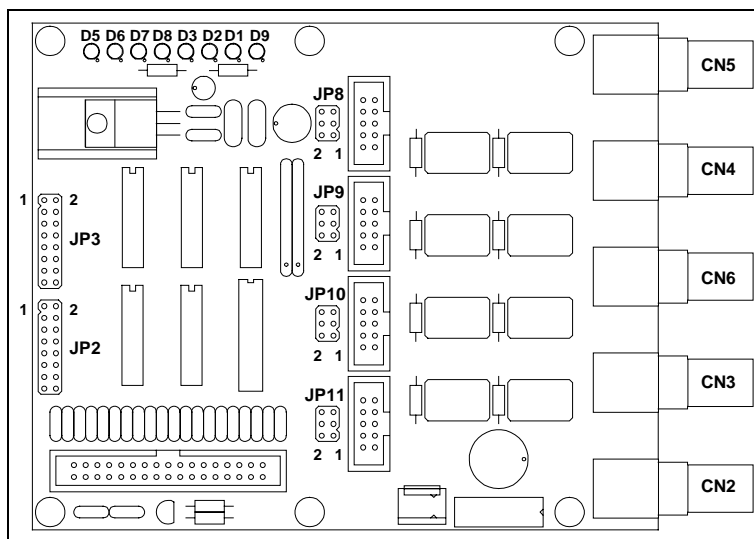

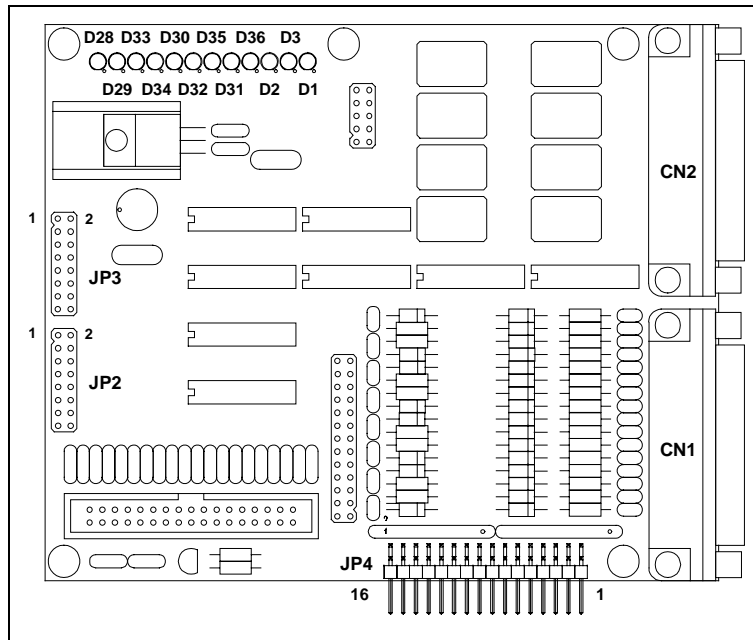

9.2 Setting of the Dip-Switches

The figure shows a part of the panel card that highlights the 24 Dip-Switches, divided into 3 parts of 8 switches each, numbered from one to three. Use the following numbering to determine the position of the individual switch:

- Sw1.1: this is the first switch of the first part.
.....
- Sw24.3: this is the last switch of the last part.

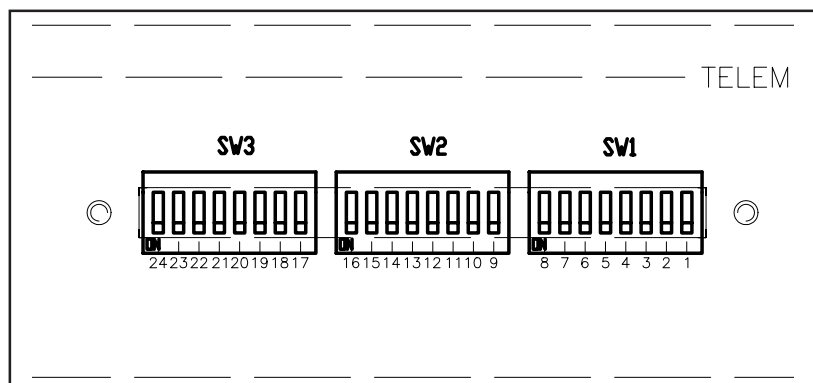

9.2.1 Setting of the Dip-Switches

9.2.1.1 Modem type

With these two Dip-Switch can be chosen the type of modem connected to the system acting as the indications of the table.

Modem type	Sw 1.1	Sw 2.1
None	Off	Off
PSTN	On	Off
PAGER	Off	On
GSM	On	On

9.2.1.2 Baud Rate

With these two Dip-Switch can be chosen the type of baud rate of the modem as the indications of the table.

Baud Rate	Sw 3.1	Sw 4.1
1200	Off	Off
2400	On	Off
9600	Off	On
19200	On	On

9.2.1.3 Address

The address of the machine comes determined through the Dip-Switches from Sw5.1 to Sw10.2 in binary shape, remembering that if it will come set up number 4 (100 in binary) the effective address will become 5 since is not possible to have the address 0. Below are described some of the possible combinations.

	Sw 5.1	Sw 6.1	Sw 7.1	Sw 8.1	Sw 9.2	Sw 10.2
1						
2					On	
3				On		
4				On	On	
5			On			
6			On		On	
7			On	On		
8			On	On	On	
						...

9.2.1.4 Number peripheral presents in I²C bus

The number of the devices connects through I2C bus comes determined to you from the Dip-Switches from Sw11.2 - Sw16.2, like in the previous case in binary shape.

	Sw 11.2	Sw 12.2	Sw 13.2	Sw 14.2	Sw 15.2	Sw 16.2
1						
2					On	
3				On		
4				On	On	
5			On			
6			On		On	
7			On	On		
8			On	On	On	
						...

9.2.1.5 Device Type

The device have work in three ways::

Generic: The alarms of forward ande reflected power are disabled.

Pj : The alarms of forward and reflected power are enabled and the machine connected to to solid state system.

Vj: The alarms of forward and reflected power are enabled and the machine connected to to tube amplifier system.

To determine therefore the operation mode is acted on the switches like described in table.

Operation mode	Sw 11.2	Sw 12.2
Generic		On
Pj	On	
Vj		On

9.2.1.6 Attenuation thresholds of the standard alarms standard

This possibility regards only the standard alarms standard (forward and reflected power) and for the corrected operation of device on systems that work with reduced power they can reduce the threshold of the alarms acting like described in table. In case of normal operation the alarm releases at 50% of the present tension of the first 2 balanced inputs of the first card of telemetry. Setting, therefore, one attenuation of 3dB will have alarm at 32% (50% - 18% = 32%) of the maximum tension (5V).

Attenuation	%	Sw 19.3	Sw 20.3	Sw 21.3
0 Db	0			
1 dB	7	On		
2 dB	13		On	
3 dB	18	On	On	
4 dB	22			On
5 dB	27	On		On
6 dB	30		On	On
7 dB	33	On	On	On

9.2.1.7 Alarms disabilization

Is possible disable the standard alarms (forward and reflected power) also in case of devices connected to standard RVR systems (Pj and Vj) acting on Sw22.3 and placing it in ON.

The user alarms can also be disabled (those setted from PC) acting on Sw 23.3 and placing it in ON.

9.2.1.8 Visualization of the alarms through relay

In the case of TLC300, since no visualization is present on the frontal panel, a specific relay can be enable in order to supply one simple visualization through the dip-switch 24.3.

This page was intentionally left blank

10. Test Board Description

10.1 The board

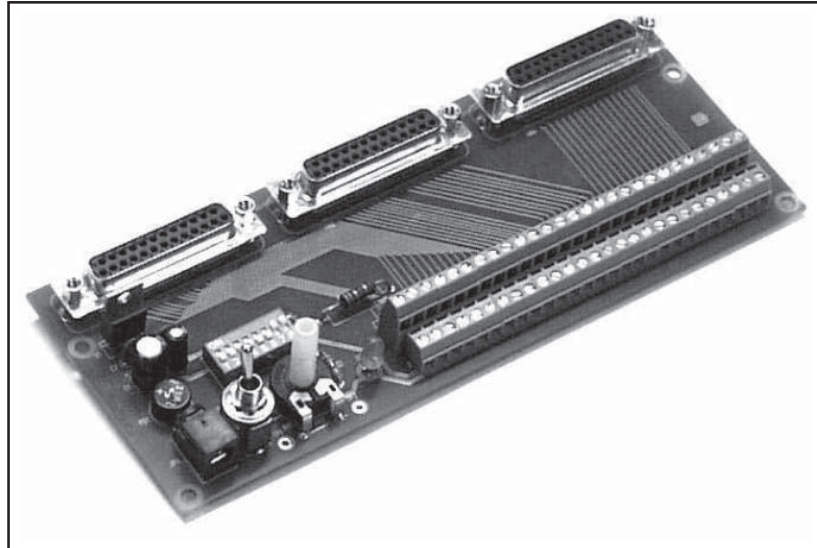

10.2 The meant of the clips

10.2.1 Balanced Analog Input

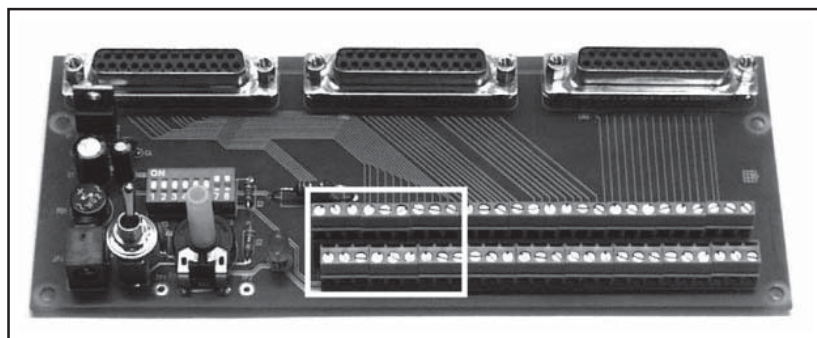

Inside the white rectangle are evidences the clips relative to the 8 balanced analogic inputs described in the following table.

Pin number	Meant
IN1+, IN1-	Balanced analogic input n°1
IN2+, IN2-	Balanced analogic input n°2
IN3+, IN3-	Balanced analogic input n°3
IN4+, IN4-	Balanced analogic input n°4
IN5+, IN5-	Balanced analogic input n°5
IN6+, IN6-	Balanced analogic input n°6
IN7+, IN7-	Balanced analogic input n°7
IN8+, IN8-	Balanced analogic input n°8
GND	GND

The tension applicable to these inputs can have values comprised between 0 and 12 V.

The TLC will have however always 5V of reference and, for superior tensions, the Data Base will have to be modified in the Telecon program inherent the wished input and opportunely regulate the relative trimmer on the telemetry card.

10.3 Digital/Analog Input

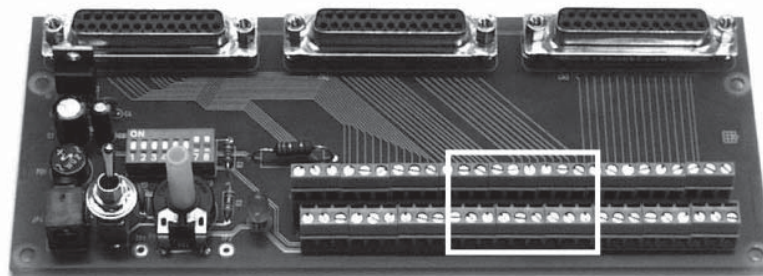

Inside the white rectangle is evidences the clips relative to the 16 Digital/Analogic inputs described in table.

Pin number	Meant
IN9	Digital/analogic unbalanced input n°1
IN10	Digital/analogic unbalanced input n°2
IN11	Digital/analogic unbalanced input n°3
IN12	Digital/analogic unbalanced input n°4
IN13	Digital/analogic unbalanced input n°5
IN14	Digital/analogic unbalanced input n°6
IN15	Digital/analogic unbalanced input n°7
IN16	Digital/analogic unbalanced input n°8
IN17	Digital/analogic unbalanced input n°9
IN18	Digital/analogic unbalanced input n°10
IN19	Digital/analogic unbalanced input n°11
IN20	Digital/analogic unbalanced input n°12
IN21	Digital/analogic unbalanced input n°13
IN22	Digital/analogic unbalanced input n°14
IN23	Digital/analogic unbalanced input n°15
IN24	Digital/analogic unbalanced input n°16
GND	GND

The tension applicable to these inputs can have values comprised between 0 and 5V.

The TLC converts these tensions in digital points and that the last use is reserved to the Telecon Program in which the date base will have to be modified inherent the wished input for the destined use.

10.4 Rly Output

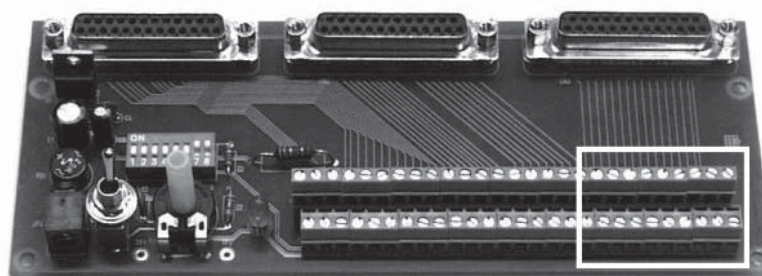

Inside the white rectangle is evidences the clips relative to the 8 relay outputs described in table.

Pin number	Meant
RLY1 (C), RLY1 (NO)	Relay n°1
RLY2 (C), RLY2 (NO)	Relay n°2
RLY3 (C), RLY3 (NO)	Relay n°3
RLY4 (C), RLY4 (NO)	Relay n°4
RLY5 (C), RLY5 (NO)	Relay n°5
RLY6 (C), RLY6 (NO)	Relay n°6
RLY7 (C), RLY7 (NO)	Relay n°7
RLY8 (C), RLY8 (NO)	Relay n°8
+12V, GN12V	Power Supply

The voltage applicable to these outputs can have values comprised between 0 and 200V with current not superior to 500 mA, otherwise it could be caused the destruction of the relay.

The TLC can excite in 3 different ways (Toggle ON, Toggle OFF, Bistable) every single relay, and such modality comes given through the Telecon Program in which the Data Base will have to be modified inherent the wished output for the use to which it is destined.

10.5 Connection to TLC

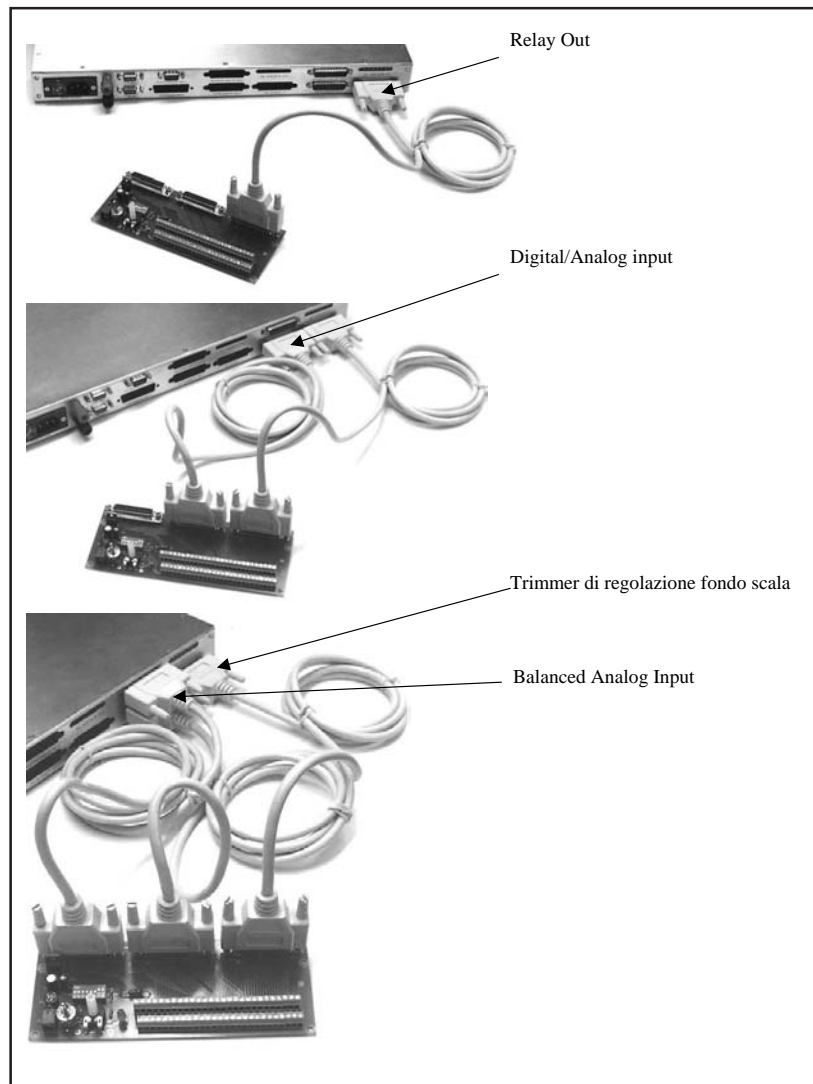

10.6 How to make the tests

In order to carry out some simple tests with the card proceed as it follows:

10.6.1 Connection to TELECON

Configure TLC so that does not need of the modem, connect the PC and the equipment through a normal 9 poles serial cable and launch the TELECON application. To this point must appear the window under visualized.

10.6.2 Balanced Analog Input

- Place in ON position the Dip-switches 5 and 6 of SW2.
- Verify that moving RV1 it modifies the reading of the analogic instrument called “Balanced Analog input # 1” regarding the first analogic input of the telemetry to which is connected the card.
- Place in OFF position the Dip-switches 5 and 6 of SW2.



Remember to supply to the test card the voltage of 12 V, that can be continuous or alternated, necessary to its operation and to connect well the 25 poles cables between the same connectors.

10.6.3 Digital/Analog Input

- Place in ON position the Dip-switch 4 of SW2 that will have to remain inserted for all the Test duration.
- Place in ON the Dip-switch 1 of SW2 and verify that moving the switch SW1 it modifies the reading of the first digital input, correspondent to Type 8= analogic 9 of the telemetry card table to which is connected the card and the LED called “Digital Input # 1” is illuminated.
- Place in OFF position the Dip-switch 1 of SW2.



- Repeat the operation with the Dip-switch 2, than with the Dip-switch 3, verifying that are modified respectively the input Type 8=analogic 10 and Type 8=analogic 11 of the telemetry board and the led “Digital Input #2” and “Digital Input #3”.
- Place in OFF position the Dip-switch 4 of SW2.



This test can be carried out without power supplying placing the inputs in Pull-up.

10.6.4 Rly Output

Insert the Dip-switches 7 and 8, and verify that giving a commando through the two buttons “OFF LED” and “ON LED” that makes reference to the first relay of the telemetry card to which is connected the card it is turn on and turn off the led on the test card.

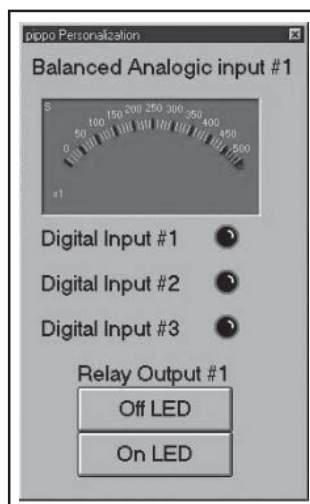

Remember to supply to the test card the voltage of 12 V necessary to its operation and to connect well the 25 poles cables between the same connectors.

Appendix A **Descrizione del software Telecon / *Telecon software description***

Questa parte del manuale contiene informazioni e dettagli tecnici riguardanti l'uso del software di telecontrollo per i sistemi SCM-TLC.

This part of the manual contains informations and technical details about the use of remote control software for SCM-TLC systems.

Table of Content

1. Remote Control Software Description	1
1.1 Functioning	1
1.2 Installation	1
1.3 Esecution	2
1.4 Functioning	4
1.5 Programation of a remote station	11
1.6 Structure of the stations.	14
1.7 Structure of the database	16
1.8 Creation of groups and stations	19
1.9 Creation and editing of the Personalization window	24
2. Monitoring Telemetry Stations	33
2.1 Functioning	33
2.2 Installation	33
2.3 Telemetry software	33
2.4 Scheduling functions	37
2.5 Technical information concerning the realization	39
3. Interconnection example (TLC)	43
3.1 In Digital with RVR's LCD Equipment	43
3.2 In Analogic with RVR's LCD Equipment	44
3.3 In Analogic with Generic Equipment	44
4. Commands from remote (TLC)	47
5. Massages on the Modem State (only TLC2000)	49

1. Remote Control Software Description

1.1 Functioning

The program exploits the serial connection through RS232 with a modem for the connection to a remote RVR station.

Each RVR station is composed of several parts called "modules" that can be called sequentially in order to receive and send data. These data are interpreted in order to obtain the measurement value to which they refer.

The connection is always realized starting from the first module, either when the station is composed of several modules (TLC300, TLC2000, SCM) or when the station is composed of a single module (PTXLCD).

The maximum connection speed is 19200 baud when transmitting with a traditional telephonic line and 9600 baud when transmitting with a GSM telephone line.

1.2 Installation

- Insert the CD-ROM in the CD-ROM player.
- From the desktop, open "Program Manager".
- Double click on the CD-ROM player icon to display its content.
- If you are using Windows2000, double click on the program "setup_telecon_win2k.exe" to install the software
- If you are using Windows95, 98 or Me, double click on the program "setup_telecon_win9x.exe" to install the software
- It may be required to install the necessary drivers for the access to data, before installing the software.
- When the installation is completed, the "Tlc32bit" group which contains the programs: "Telecon 32bit" and "GSM Init" will be created, then the connection icons will appear on the Desktop.

System Requirements:

- Windows 95 ®, Windows 98 ® either first or second edition, Windows ME ®, Windows NT ® and Windows 2000 ®.
- Processor:
Intel Pentium ® 75 MHz or better.
- Minimum Memory required:
16MB Ram.
- Minimum capacity on Hard Disk required:
50Mb.

1.3 Esecution

Double click on the "Telecon 32bit" icon present on the desktop or select Telecon 32bit from the "Start" menu -> Programs -> TLC32bit -> ", in order to start the program.

1.3.1 How to choose and configurate a station

In the main window it is possible to choose the station you wish to call and edit the parameters that refer to communication.

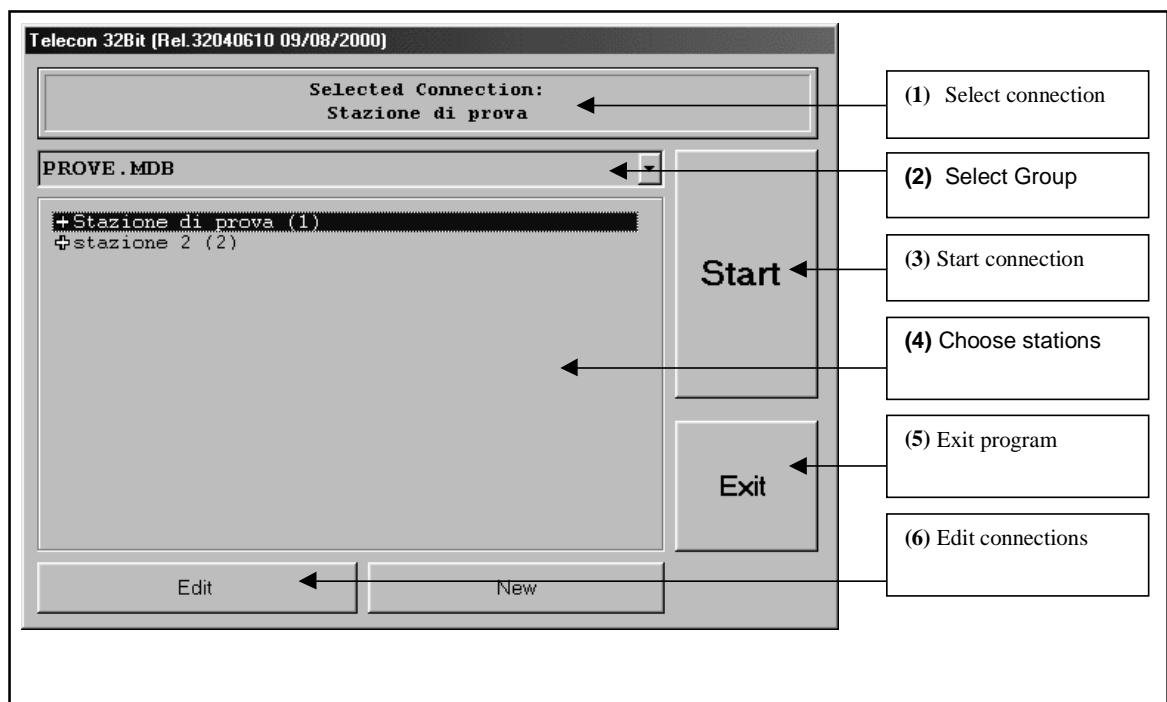

- The window showing the "Chosen connection " (1) indicates which station will be called when the "START" button is selected (3).
- When clicking on "Select Group" menu (2) it is possible to choose between the different groups of stations (if saved)
- The "START" button (3) launches the call to the station.
- The "EXIT" button (5) exits the program.
- When clicking on "Select stations" (4) it is possible to choose among the present stations which one will be called, the selection inside the window will then change (1).

When pressing the cross situated on the left side of the name of the station, the description of the station is displayed.

The station is composed of 2 menus:

- "Connection Configuration" containing the connection parameters (init string of the modem, telephone number, etc..),

- "Station Configuration" containing the composition of the station.

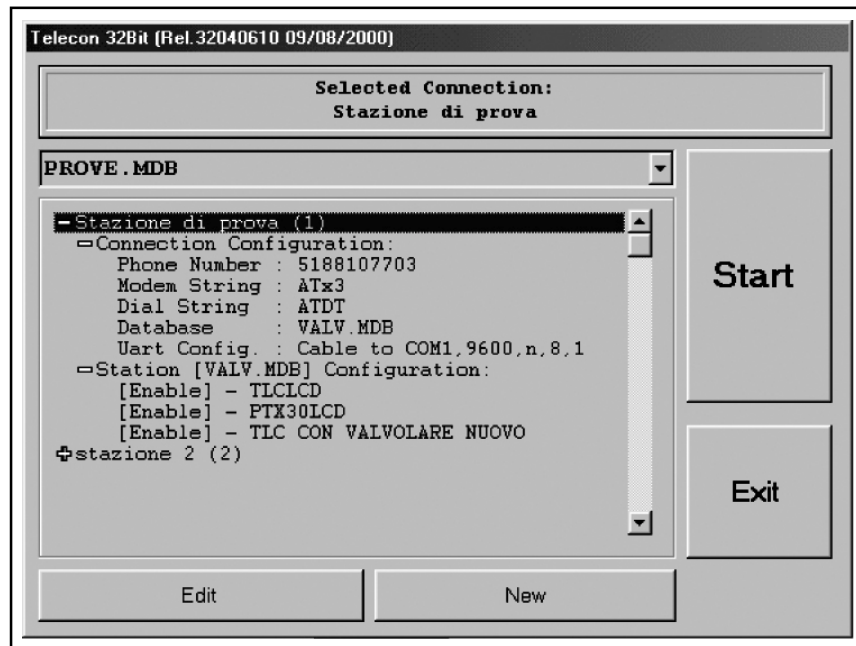

- When you click on the "Edit connections" button (6) the window shown in fig 3 is displayed, from there you can edit the different connection parameters of each station.

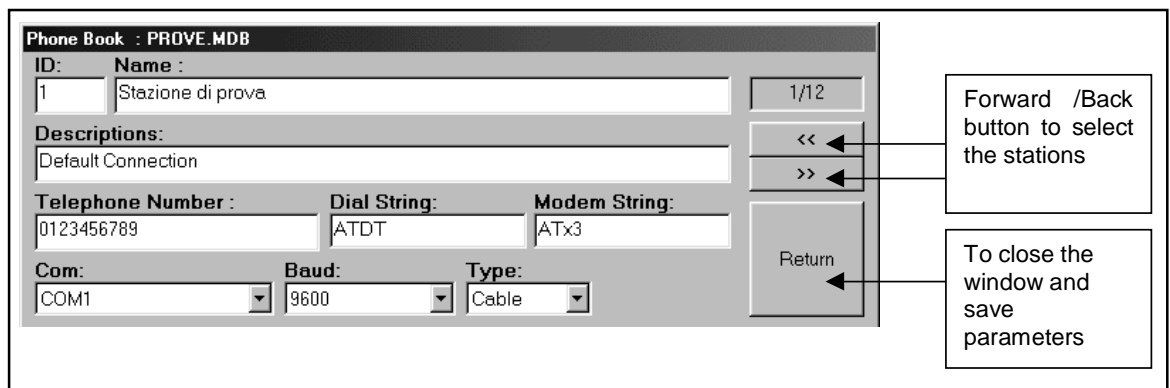

The first time you use the software, it is necessary to enter:

- The telephone number,
- The COM port used,
- the Baud rate,
- the type of connection (direct through cable, through telephonic modem or GSM).

In order to avoid functioning problems, we will not give instructions concerning stations

building. Please kindly contact R.V.R. S.p.A. if you wish to put additional stations.

1.3.2 Connection

When the station is selected, press "START" (3).



The connection window is displayed, and it will remain displayed until the connection is completed.

In case the telephone line is busy, it will be possible to make a new connection attempt by pressing the "Retry" button.

The "More Detail >>" button enables to get further information concerning the status of the station.

The "Exit" button brings you back to the "station selection" window.

1.4 Functioning

The program has 2 interfaces:

1.4.1 How to personalize

The first interface called "Personalization" is displayed when the station is connected.

This interface is easy to use and it enables the user to check, whenever he wants, the status of the station in a fast way (fig. refers to the personalization of a VJ25000).

Apart from the various indicators either analogical or digital and the alarm leds, there are also a few buttons that enable to select most frequently needed functions (switch on/off, alarm reset).

When pressing one of these buttons, the user is asked to confirm the current function selected.

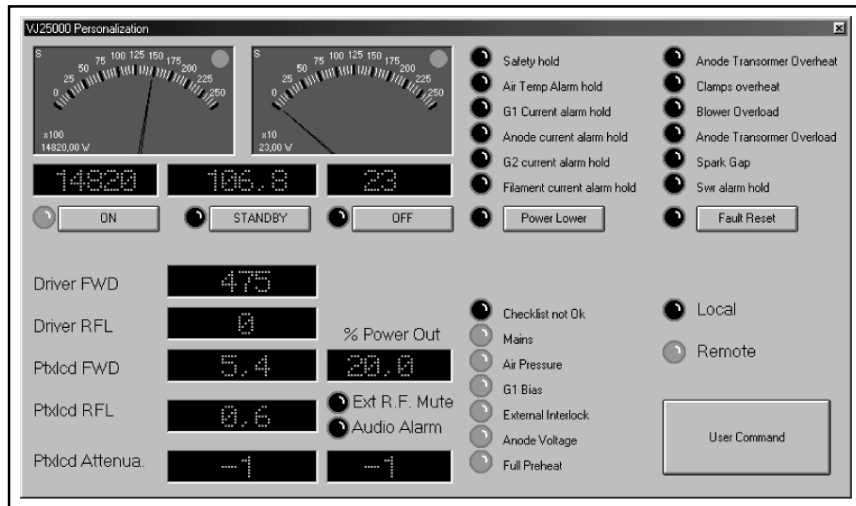

In order to change some levels such as attenuation of the inputs and the output power percentage of the PTXLCD, double click on the measurement that you wish to change and insert the new value required.

If you wish to create or modify the personalization, please refer to Chapter "Creation and editing of the personalization window".

1.4.2 Standard interface

Behind the Personalization window, there is the standard Telecon interface.

It is composed of 5 main areas:

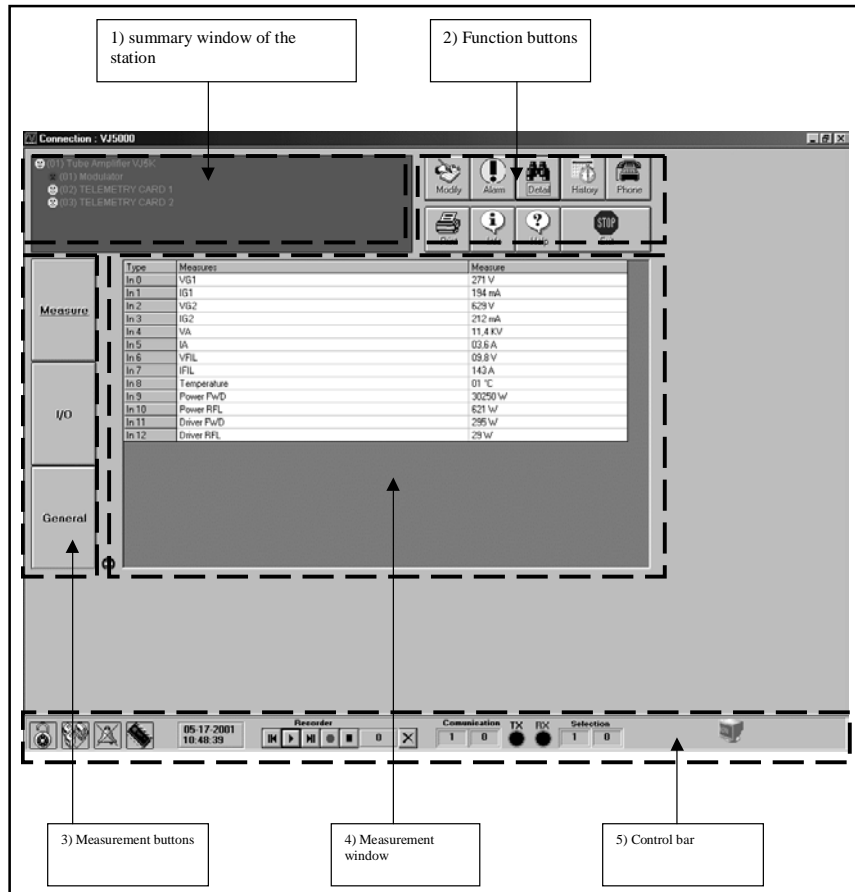

1) **Summary window of the station**



As you can understand from its name, it indicates the parts that compose the station (obviously as far as telemetry is concerned).

When you click on the components (modules), the window with the data concerning measurements are displayed (3).

2) Function of the different buttons



- "Alarm" button:

The "Alarm" button enables to open the window showing the chronological list of the alarms that may have appeared (only for SCM and TLC units).

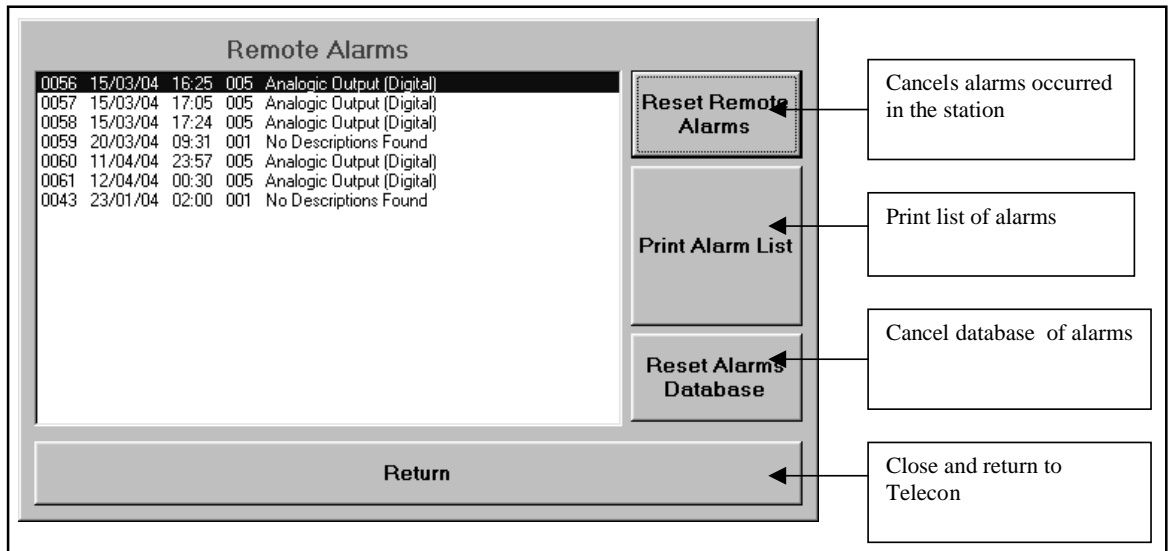

Apart from being saved in the station, the occurred alarms are included in the database of the station itself.



- "Detail" button:

The "Detail" enables to open the personalization (See point 10.4.1).



- "History" button:

The "History" button enables to open the window containing the schedule (this function is not available in this software version).



- "Print" button:

The "Print" button enables to print the status of the station: a page for each module with the different measurements as displayed on the measurement window (3).



- "Info" button:

The "Info" button enables to open a window in which it is possible to select the modules in order to get information concerning the software and hardware versions, the number of analogical and digital I/O.

PTX30LCD	
Type	PTX30LCD
Rel.Software	2,01
Rel.Hardware	1,01
Num.Module	1
Analog Input	40
Analog Output	2
Digital Input	32
Digital Output	64
General I/O	16

Return



- "Phone" button:

The "Phone" button enables to open the window showing the set-up of the telephone numbers saved in the memory of the SCM.

N.B. This option is only valid if the SCM is connected to an analogical modem.



- "Help" button:

The "Help" button enables to open the online guide.

- "Exit" button:



The "Exit" button enables to exit the program.

3) The buttons to select measurements:



- "Measure" button:

The "Measure" button enables to visualize the inputs, either balanced analogical or analogical/digital, in the "Measurement window "(4).



- Il tasto "I/O":

The "I/O" button, enables to visualize the outputs of the "Measurement window "(4).



- “General” button:

The "General" button, enables to visualize the general measurements of the "Measurement window "(4).

4) The measurements window:

Measurement type	Measurement name	Received value
Type	Measures	Measure
In 5	RDS	0 %
In 2	Modulazione	5 KHz
In 6	Variacap Voltage	8,45 V
In 7	Negative Voltage	-11,38 V
In 8	LCD Inverter	0,00 V
In 9	Internal 15V	15,25 V
In 10	CPU Voltage 5V	5,06 V
In 13	Pa Voltage	5,62 V
In 14	PA Current	0,08 A
In 17	Dirver Voltage	2,64 V
In 18	Driver Current	0,13 A
In 19	Temperature	25,43 °C
InD 24	External Interlock	RF On
Out 0	% Power Out	0,4 %

- The "Type" column indicates the type of measurement:

“In” -> analogical input,

“InD” -> digital input,

“Out” -> output.

When you click on any of the measurements, the window of the measurements set-up is displayed (obviously only for "I/O" and "General" measurement types enabled).

To enter a new value, it is necessary to write it in the "Data" box and press enter.

Measure Setting

<i>Type</i>	<i>Name</i>	
Out 0	% Power Out	
<i>Data</i>		<i>Unit</i>
10,0 %		%

Return

5) **The control bar:**

The control bar is composed of 3 parts:

- The control icons:



The password: The first icon represents the password. If this icon is activated in the station a closed lock appears on a yellow background, otherwise it is open as shown on the picture.

When you click on the icon, the window for the password selection is displayed.

The measurement cycle lock: The second icon indicates the status of the interrogation cycle of the modules. When clicking on the icon you obtain a lock of the selected module in the window displaying the summary information concerning the station (1):

It is used when it is necessary to update only a few measurements faster.

When the icon is selected, its background is coloured in red.

The bell: The third icon enables to launch the acoustic indicator in case an alarm is received.

The programation of a station: When the third icon is selected, the remote programation window is displayed in the preset stations.

When the station is preset, it is not necessary to program the data on the SIM card of the GSM modem since they are saved in the unit itself.

Please read Chapter 5: "Programation of the remote station" to know more about this function.

When you select the fifth icon, time and date are displayed.

- The recorder:

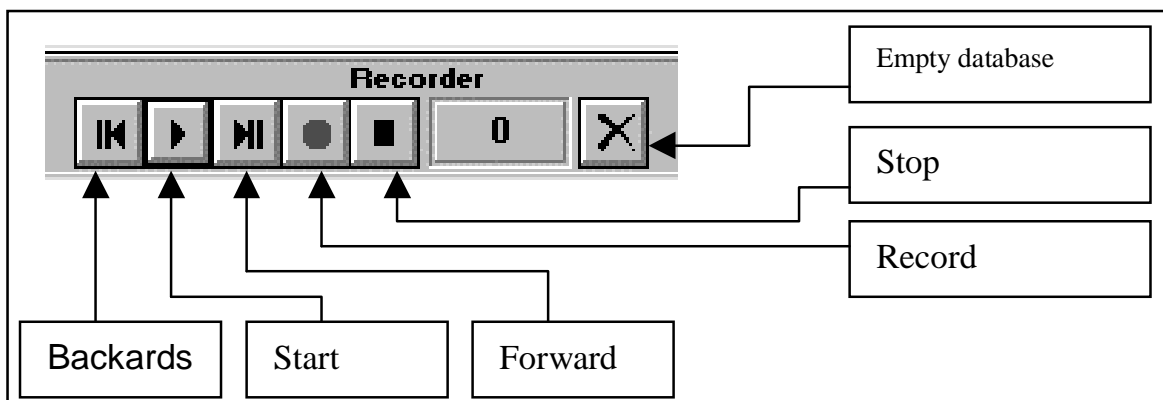

It enables to record in a database all the data received from the station.

Its functioning is similar to this of a normal tape-recorder.

- The communication status icons:

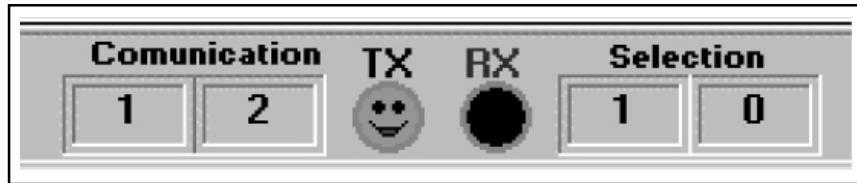

They enable to analyze the status of the serial communication.

On the left, under the word "Comunication", the nod number and the identification number of the interrogated module are displayed.

In the middle, there are two icons that indicate the status of the transmission and serial reception (green=OK, red=No).

On the left, under the word "Selection" the selected node and the module are displayed in the window displaying the summary information concerning the station (1).

1.5 Programation of a remote station



By clicking on this icon the window showing the programation of the remote station is displayed.

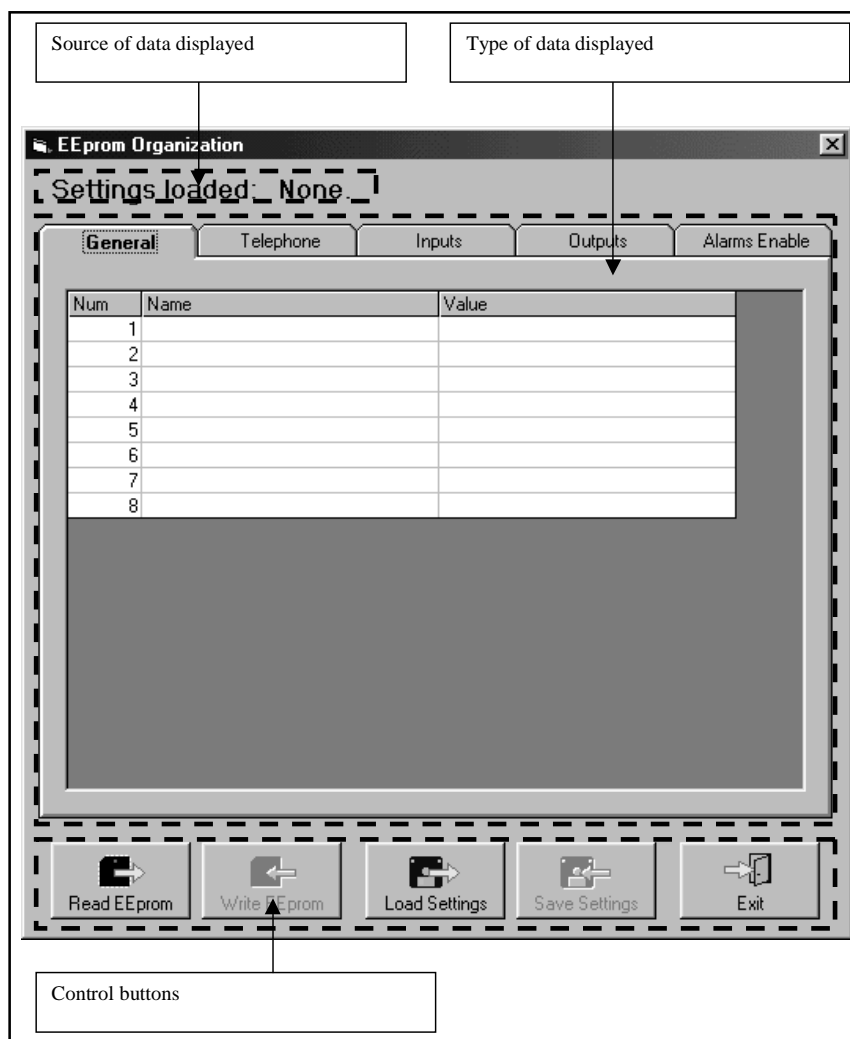

From this window it is possible:

- To read and write the parameters of the remote station,
- Enter and save the parameters in the database of the station itself.

When the window is displayed it does not contain any data, it is necessary to read them from the remote station or from the database.

1.5.1 How to select functions



Press this button in order to read the parameters of the station.



Press this button in order to program the parameters in the station.



Press this button in order to read the parameters from the database of the station.



Press this button in order to write the parameters in the database of the station.

In this way, each station memorized in the Telecon software contains the programmed parameters.

The type of data identify the groups of options that can be programmed:

- 1) General: these are the parameters common to all the types of RVR stations.
 - ID of the station
 - Name of the station
 - Number of the SMS Assistance Center
 - Number of SMS attempts
- 2) Telephone:
 - Phone numbers recognized by the station
 - Enables to send SMS messages to the system
 - Enables the reception of SMS messages.
- 3) Inputs: monitoring of the auxiliary inputs that generate alarms (in the predisposed systems).
 - Name of the alarm (that is transmitted in the message)
 - Intervention threshold of the alarm in percentage (0% = 0VDC, 100% = 5VDC)
 - Alarm activation front (indicates whether the alarm is activated or not in case of supply failure).
- 4) Outputs: monitoring of the outputs (in the predisposed systems)
 - Type of output commutation (status, impulsive ON or impulsive OFF).
- 5) Alarms Enable: (in the preset systems)
 - Enables the standard alarms of the station.

When you click on the parameter that you intend to modify, the data entering window is displayed.

The window is slightly different in function of the type of measurement that is to be modified.

Window for the entering of names and numbers. It is possible to write whatever.

Window for the entering of data. It is necessary to choose between the proposed options.

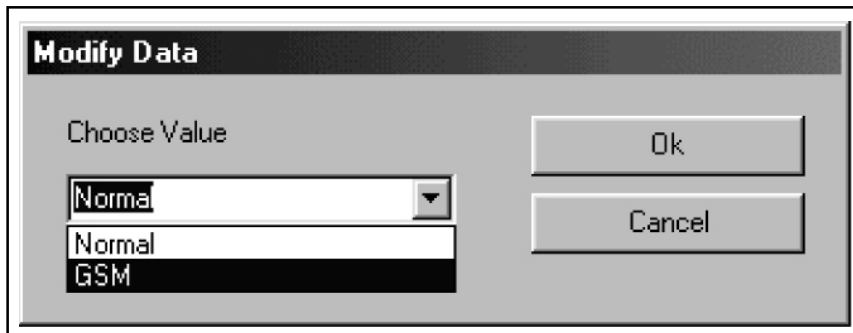

1.6 Structure of the stations.

The Telecon software works exclusively with databases.

Each station present in the Telecon, is composed of several blocks called Modules.

Inside the program folder, there are four folders called: Default, Module, Phbook and Stations, which contain the database of the stations.

Structure of the stations:

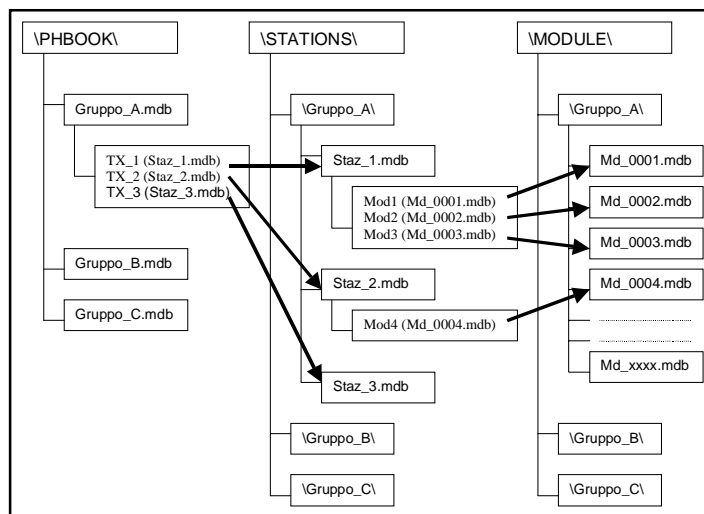

When the program is started the database used situated in the folder \PHBOOK\ is shown, ex. "Group_A.mdb". Each group represents a series of stations.

The database situated in the folder \PHBOOK\ contain the general information concerning the stations: telephone number, connection Baud Rate, COM port used, etc.

Each station included in a "Group_A.mdb" has a connection to a database situated in the folder \STATIONS\Group_A\, which contains the names of the database of the modules that compose it. Such databases are situated in the folder \MODULE\Group_A\ and are copied and renamed when the creation of the station from the folder \DEFAULT\ happens.

Example: Let's imagine a group called "Radio1", which contains one station only called "TX500".

The record of the database "Radio1.mdb" will be composed in the following way:

D	Name	Descriptions	Phone	ModemString	DialString	DBName	Com	Baud	Type	InitString	Protocol
1	TX500	-- None --	01239	ATX3	ATDT	TX500.MDB	1	4	0	9600,n,8,1	PROTOCOL_RVR

The area "DBName" contains the name of the database (TX500.mdb) situated in the folder \STATIONS\Radio1\ which contains the information concerning the composition of the station.

The database of the station, is composed by five tables:

- Alarm

Contains the data concerning the received alarms.

- Alarm_Storic

Not exploited.

- Configuration

Contains the data concerning the composition of the station.

- Measure_Storic

Not exploited.

- Personal_Window

Contains data concerning the personalization window.

Therefore in the "Configuration" table of the database \STATIONS\Radio1\TX500.mdb you will find information concerning the composition of the station.

Structure of the "Configuration" table.

Node	Module	Name	DBName	Module Number	Enabled	Type	Configuration
0	0	Total Node		1	0		
1	0	TLCLCD	MD_0001	3	-1	TLCLCD	>_ _
1	1	PTX30LCD	MD_0002	0	-1	PTX30LCD	>_ _e_
1	2	TLM PJ500	MD_0003	0	-1	TLM2	>_ _._

The area "DBName" contains the name of the databases situated in the \MODULE\Radio1\ folder which contain the information concerning the modules.

1.7 Structure of the database

The TLC300 has one (or two) telemetry cards (8 balanced analogical inputs, 16 analogical/digital inputs and 8 relay outputs) and one I2C.

When seen through the Telecon, each telemetry card present and each unit connected through I2C appear as Modules

There are some acknowledgements to respect:

- 1) The first Module (number 0) ALWAYS contains the unit which is equipped with telemetry.
- 2) Then the units connected through I2C Bus are shown.
- 3) Then the telemetry cards

Let's analyze an example of typical station: TX500 equipped with telemetry (TLC300/T1).

The TX500 is composed of: one PTX30LCD, one PJ500MC and obviously the TLC300.

The station, for the Telecon, will be composed of:

- 0 - TLC300
- 1 - PTX30LCD
- 2 - Telemetry card for PJ500MC

1.7.1 The modules

Each Module has a corresponding database which contains the data concerning the available measurements.

The database, contains seven tables:

- Alarm Name
contains the information concerning the alarms
- Analog Input

contains the data concerning the analogical inputs

- Analog Output

contains the data concerning the analogical outputs

- Digital Input

contains the data concerning the digital inputs

- Digital Output

contains the data concerning the digital outputs

- General

contains the data concerning the general measurements

- Info

contains the information concerning module

N.B. In function of the type of unit that they represent, the tables can also contain data.

Let's Analyze the module related to the standard telemetry card: it contains: 24 analogical inputs (8+16) and 8 relay outputs; therefore data will be found only in the Analog Input and Digital Output tables.

Similarly, for the PTXLCD (which has 39 analogical inputs, 2 analogical outputs, 8 digital inputs, 29 digital outputs, 8 general measurements), data will be found in all the tables.

All the tables (except Info and Alarm Name) have the same structure:

Name of area	Type of data	Description
Key	Numerical	Univocal identification key
ID Measure	Numerical	Identification of the measurement
Display Order	Numerical	Ordering displayed data
Enable Input	Yes/No	Enable input
Enable Display	Yes/No	Enable display
Name	Text	Measurement Name
Measure Unit	Text	Measurement Unit
Conversion Type	Text	Type of conversion
End Scale	Numerical	End scale
Start Scale	Numerical	Start scale
Max	Numerical	Maximum value
Nominal	Numerical	Nominal value
Min	Numerical	Minimum value (offset)
Format	Text	Displaying Format
Input Mask	Text	Input Mask
Resolution ADC	Numerical	Resolution ADC converter
Type	Numerical	Type of measurement
Text for Max	Text	Text to be displayed when maximum value is reached
Text for Min	Text	Text to be displayed when minimum value is reached

For example:

The first analogical input of the telemetry card is composed in the following way:

Key	0	Number of the measurement
ID Measure	0	Position in the order display
Display Order	1	It is possible to enter values (not for the inputs)

Enable Input	Si	It is displayed on the Telecon grids
Enable Display	Si	Name of the measurement
Name	Analogical 1	Name of the measurement
Measure Unit	V	Measure unit, Volt
Conversion Type	TENS/CORR	Conversion for voltage and current measurements
End Scale	5	Value displayed when input at the maximum
Start Scale	0	Value displayed when input at the minimum
Max	6	Value after which the alarm is generated
Nominal	0	Not used parameter
Min	0	Value under which alarm is generated
Format	#0.0	the datum has a number after the comma
Input Mask	###	Not used parameter
Resolution ADC	1024	ADC resolution (useful for calculations)
Type	1	1 = analogical input
Text for Max	???	Text displayed when at the maximum (only digital input)
Text for Min	???	Text displayed when at the minimum (only digital input)

With such settings, the voltage present at the input will be displayed.

1.7.2 How to modify the database

If the user needs to modify the measurements on already existing databases, the parameters to modify are the following:

- Conversion Type
- End Scale
- Max
- Enable Input
- Enable Display

Conversion Type: determines the calculations to make with the received datum.

The different algorithms were created in function of the requirements of the equipment manufactured by R.V.R. and include power measurements, voltage and current, logical status, etc.

End Scale: indicates the maximum value displayed corresponding to the maximum voltage applied at the input.

Max: value indicating the threshold for the generation of a visible alarm on the Telecon grids.

Enable Input: value Yes/No which indicates whether it is possible to set a measurement value.

Ex. When an input is selected it is on "No" because it is not possible to set an input value, while for measurements like i.e. the output power of the PTXLCD, it is on "Yes" because the user can choose the value he wants to enter.

Enable Display: value Yes/No which indicates whether the measurement appears in the Telecon grids has also a consequence in the personalization.

1.8 Creation of groups and stations

In this chapter we will deal both with the creation of a station and with the creation of a group.

1.8.1 How to create a group

From the main window, select the button "New".

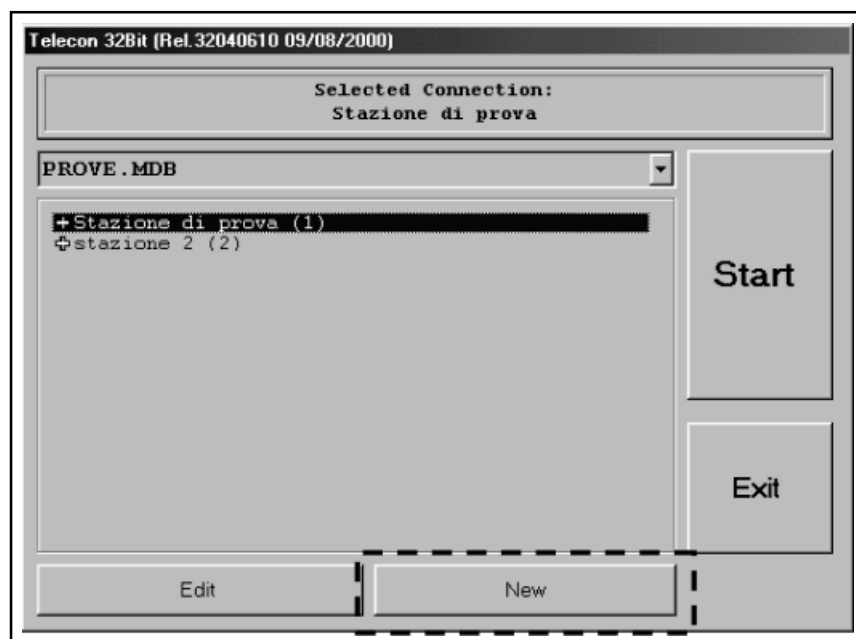

The program will ask you if you want to copy the list of stations which are part of the selected group and then it will ask the name of the new group.

At the end of the creation process, you will obtain a new group with a station called

"Default" in case you have chosen not to copy the list of stations, otherwise you will find the same list of stations that composed the original group.

1.8.2 How to create a station

From the main window, select the "Edit" button.

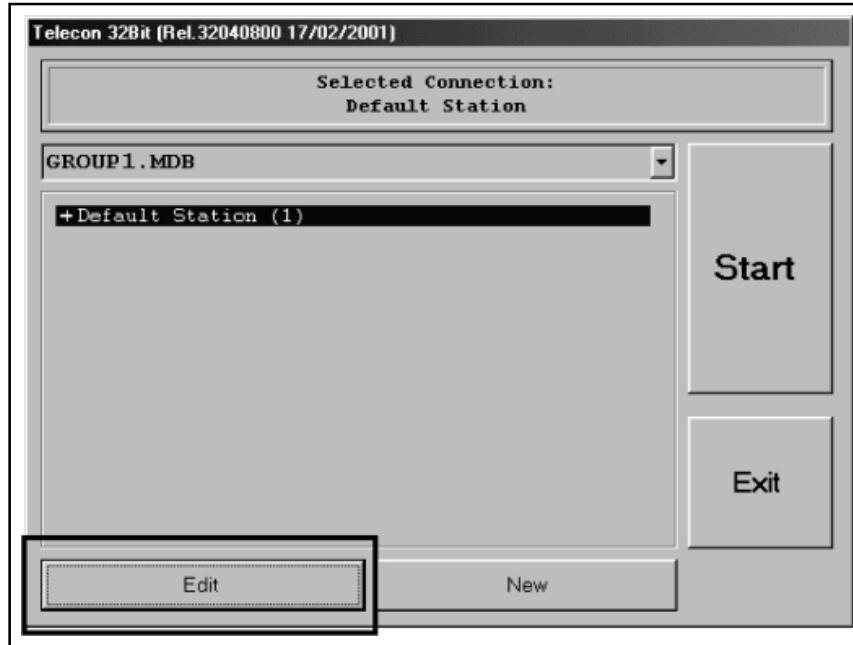

The editing window of the station will be displayed. It is important to mention that the stations are composed of two parts, one is situated in the "Phone book" window where the connection is monitored while another is situated in the structure of the station.

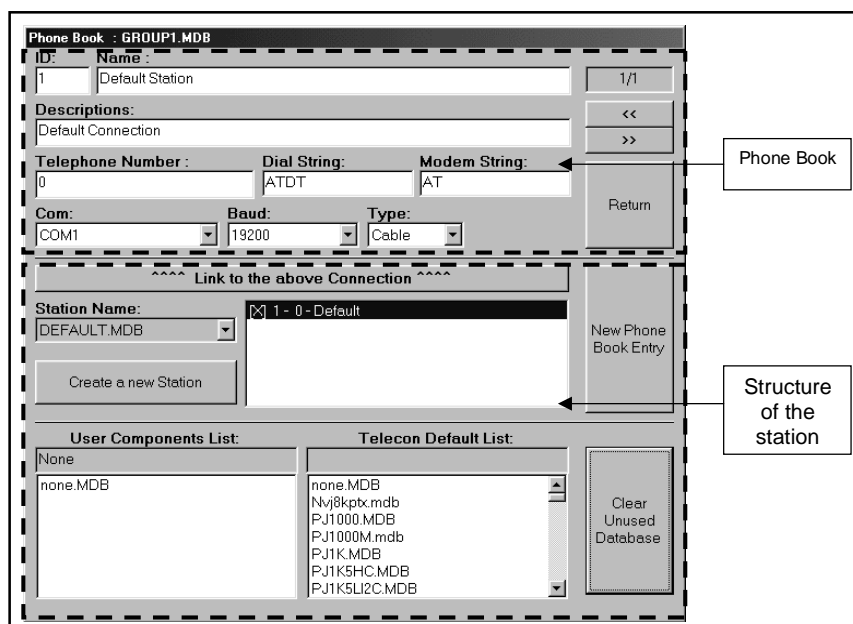

Structure of the station:

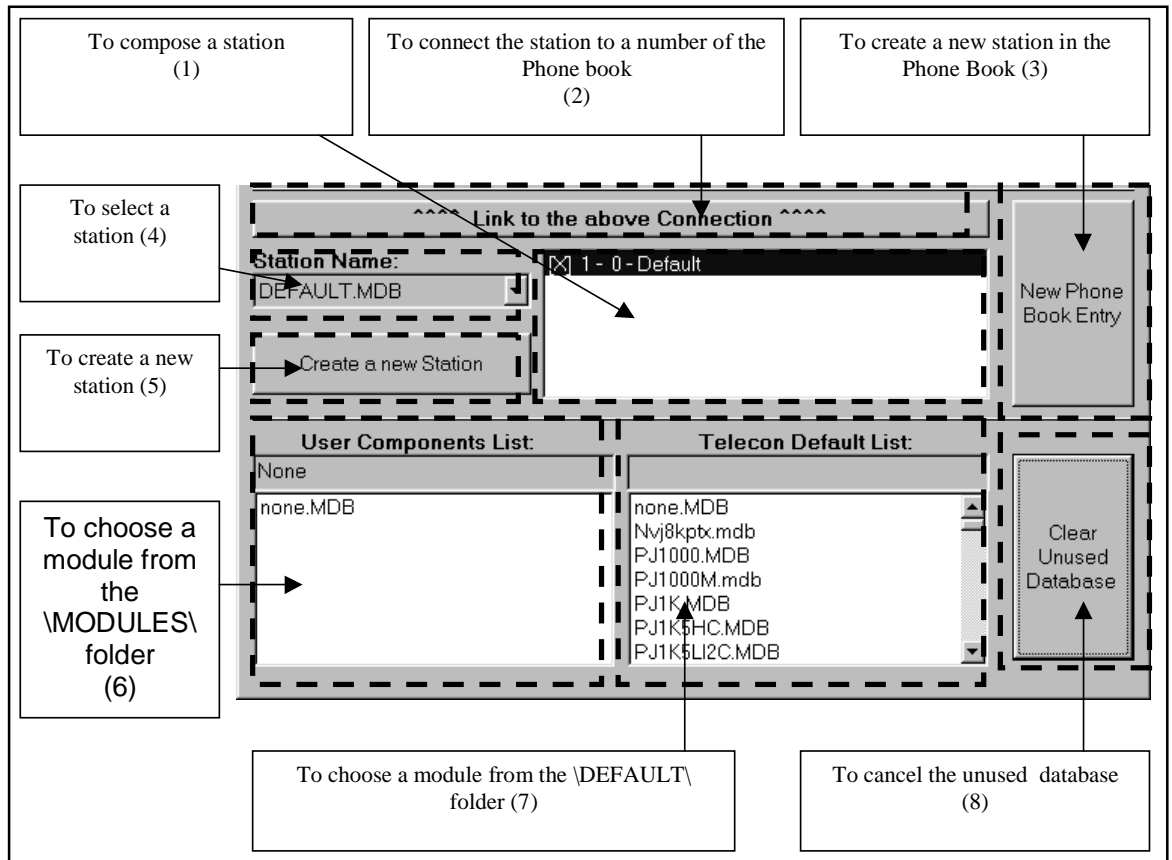

The steps for the creation of a station are the following:

The chosen station is TX500 with telemetry.

As already mentioned in Chapter 7, the station will be composed of three modules,

- 0 - TLC300
- 1 - PTX30LCD
- 2 - Telemetry of the PJ500MC

It is necessary to create a new name in the Phone Book, which can be done by selecting button (3).

- 1) Select button (5): the program will ask you whether you want to copy the station that is currently select, press "no"; enter the name of the new station (Ex.TX500).
- 2) Select the new created station from the menu (4).
- 3) In the window "Station composition " (1), you will find:

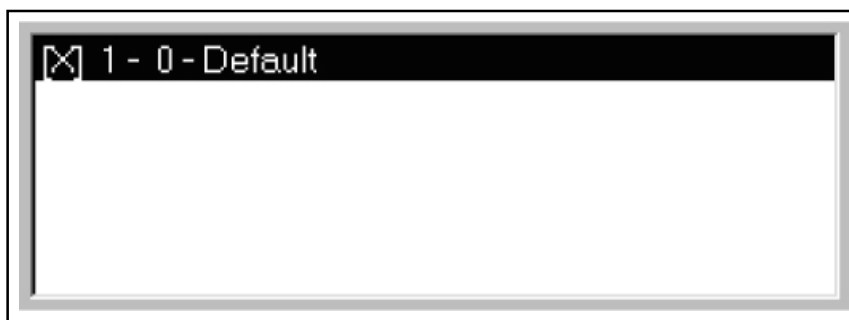

- 4) Search the module "TLC300.mdb" in the list (7)
- 5) Click on the module and keep the left button of your mouse pressed, and drag it into the window (1).

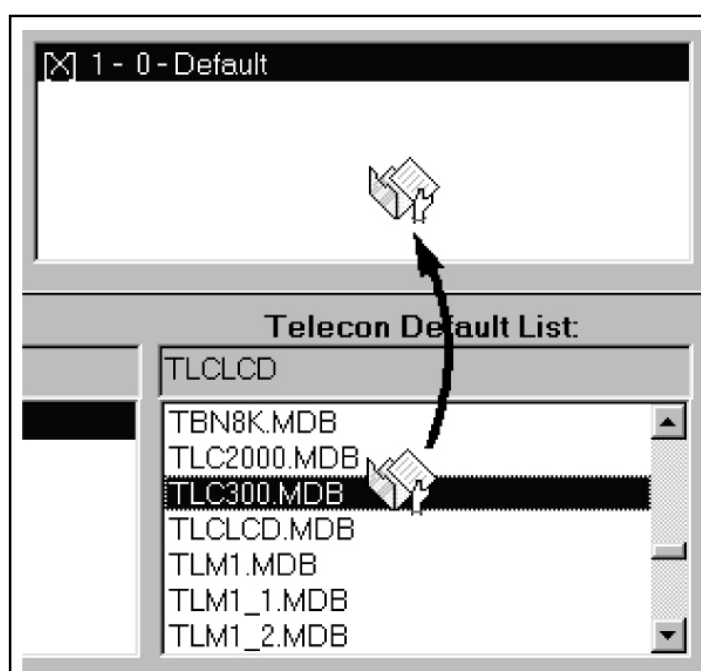

- 6) The program will ask you whether you want to replace the selected module (Default) by the module you have chosen. Select "Yes".

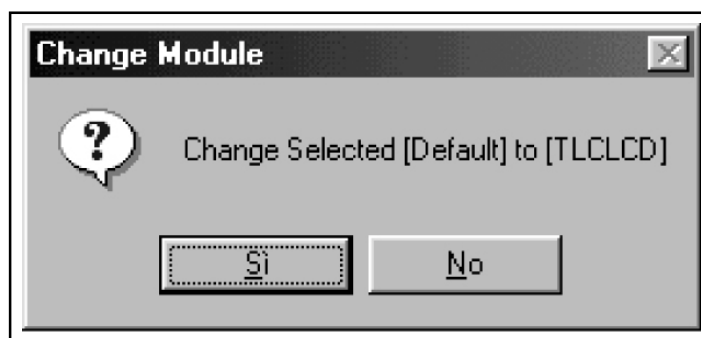

In this way you will replace the "Default" module by "TLCLCD", which are the letters identifying of the TLC300.

- 7) In the window (6) "Md_00001.mdb" is displayed, which is the "TLC300.mdb" database renamed and copied in the folder \MODULE\Group1\.
- 8) Search the module "PTX30LCD.mdb" in the list (7).
- 9) Click on the module and keep the left button of your mouse pressed, and drag it into the window (1)

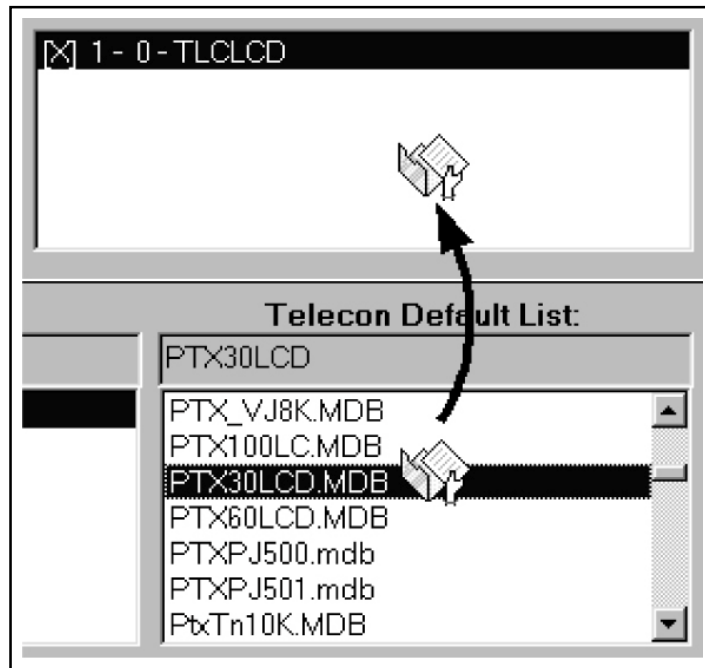

- 10) The program will ask you whether you want to replace the selected module (TLCLCD) by the module you have chosen. Select "No".

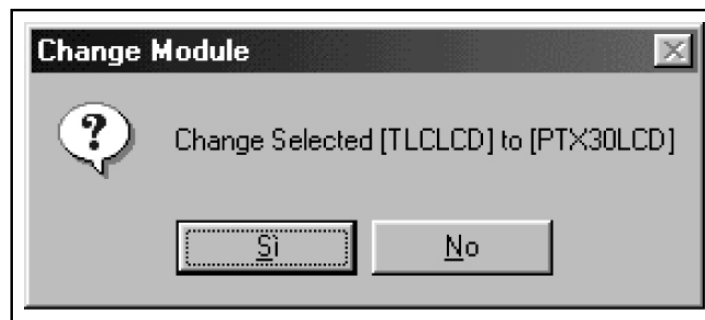

The program will ask you whether you want to add (append) the module to the configuration of the station. Select "Yes". If you choose "No" the module will not be added to the station. The program will ask you to confirm the node and module numbers, the program automatically chooses the values so they should not be changed.



In the window (6) "Md_00002.mdb" is displayed, which is the "PTX30LCD.mdb" database renamed and copied in the \MODULE\Group1\ folder.

- 11) Search the module "PJ500.mdb" in the list (7).
- 12) Repeat 8 and 9. You should obtain the situation shown in Figure:

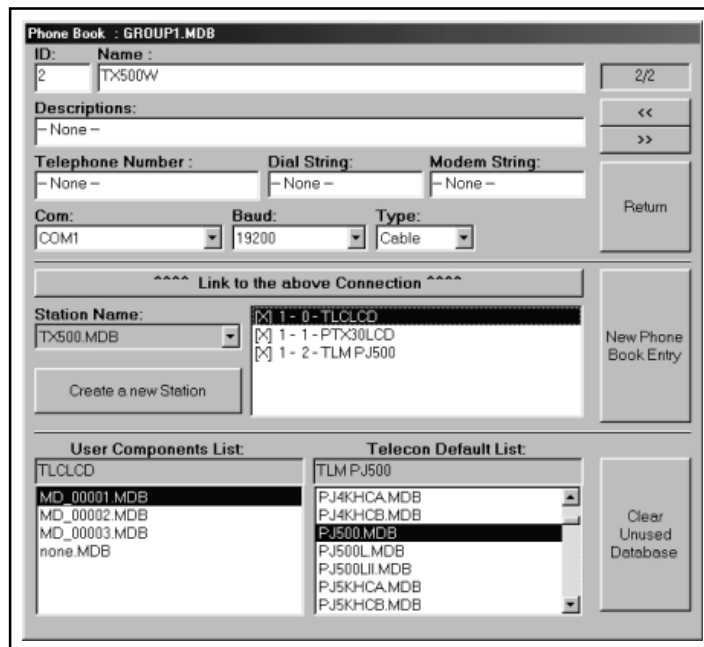

- 13) The structure of the station is completed, so it is now necessary to connect it to a number from the Phone book. In order to do so, press button (2).

The guided creation of a station is completed.

1.9 Creation and editing of the Personalization window

1.9.1 Preliminary acknowledgements

In this chapter we will analyze the creation of a personalization, starting from an empty window.

Press the "Detail" button to enter the Personalization window





Click on button "F4" situated on the window to enter the "edit" mode, the shape of the mouse cursor will change  .

Click with the right button of your mouse to enter the menu with three options:

- Add Control.

To add a control

- View Grid.

To switch on or off the display of the grid

- Save Window.

To save the personalization window.

N.B. We advise you to use this function very often in order to avoid loosing the realized work

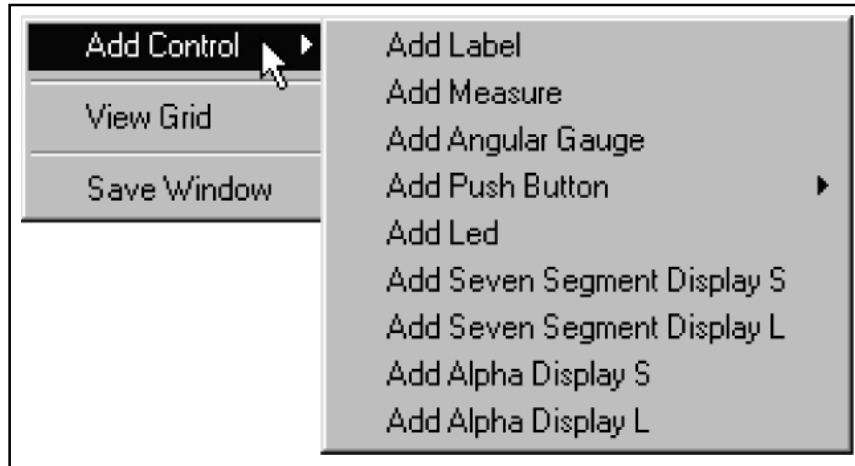

The "Add Control" menu contains the submenus from where you can choose the items that can be added in the window:

- Add Label.

Frequency

To add a label.

- Add Measure.



To add a numerical measurement (the use of the "Alpha Display") control is anyway advised

- Add Angular Gauge.

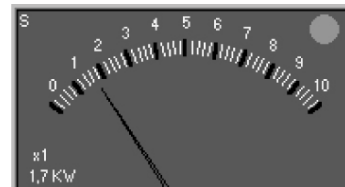

To add an analogical instrument.

- Add Pushbutton.



To add a button in order to send commands.

- Add Led.



To add a signalisation led.

- Add Seven Segment Display (S o L).



To add a LCD type display for numerical measurements

- Add Alpha Display (S o L).



To add an alphanumeric display, which may be used

1.9.2 Guided creation of a personalization

In this brief instruction chapter, we will explain the operations which are necessary in order to create a personalization window.

La station used as a reference will be a TX500 (TLC300, PTXLCD, PJ500MC)

In order to add an instrument to indicate the output forward power.

- 1) Press F4 in order to enable the EDIT mode
- 2) Click with the right button of your mouse on the area where you want to add the command.
- 3) Select "Add Angular Gauge" from the "Add Control" menu
- 4) The selection window will be displayed

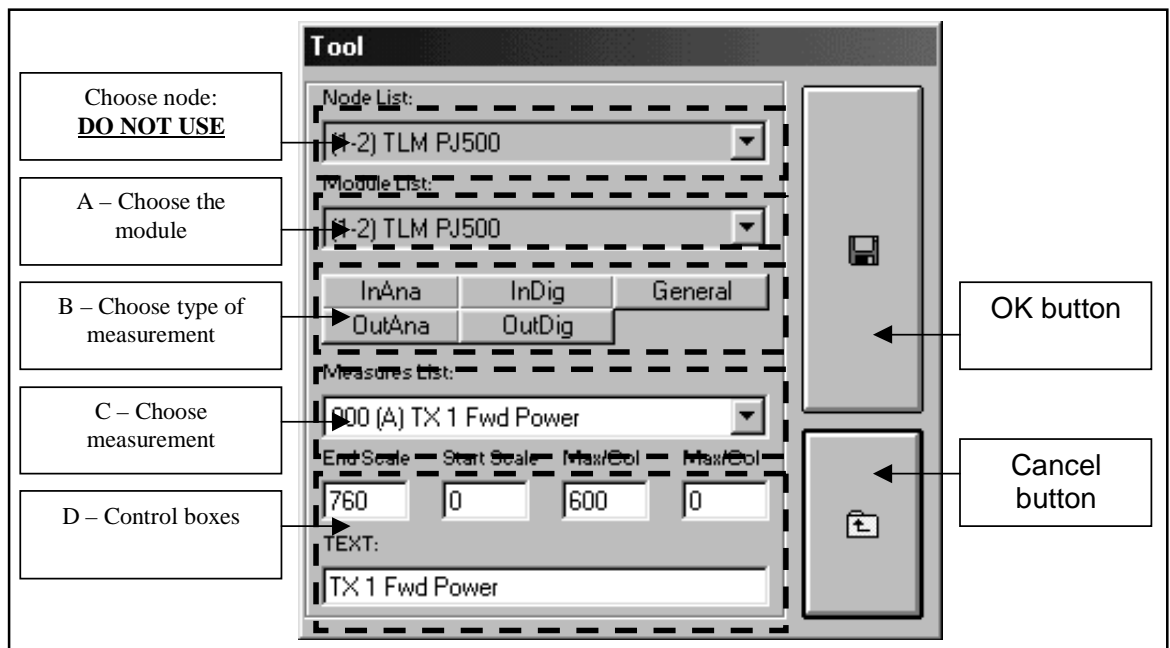

In the box "A" choose the module "1-2" which corresponds to the PJ500.

- 5) Choose between the "B" buttons, on "InAna" in order to have the list of analogical measurements displayed.
- 6) In the "C" box select the "Fwd Power" measurement.
 "000 (A) TX1 Fwd Power" means: "000" which is the input number, "(A)" indicates that the input is analogical, the remaining is the name of the input (which is the same as box "Text:" from the group "D").
- 7) These options are valid only for the "Angular Gauge" control: boxes from group "D".

If you wish to replace the end scale of the analogical meter, write the required value in the "End scale" box.

If you require a maximum value inside the scale (in order to have an alarm led on the command, when the value is superior), write it in the "Max/Col" box.

Ex: If you enter 760 as an "End scale" value and 600 as a "Max/Col" value, you will have a command as shown in the figure. Please note that when the value setted in "Max/Col" is exceeded, the green led situated on the upper and right side becomes red.

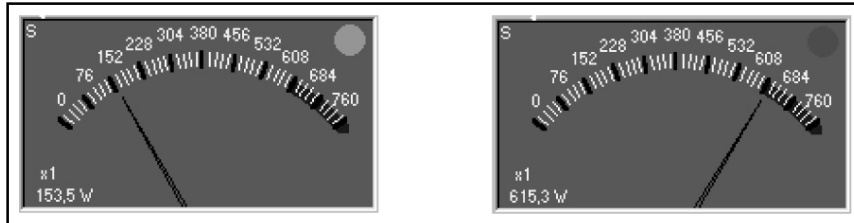

8) Press the "OK" button.

The new command was positioned. It is now possible to have it moved, redimensioned or cancelled.

Please note that when the mouse cursor passes on the control, the icon  changes. In order to move, cancel or vary the dimensions or change the parameters of the command, press the right button of your mouse. The menu from which it is possible to make choices will be displayed.

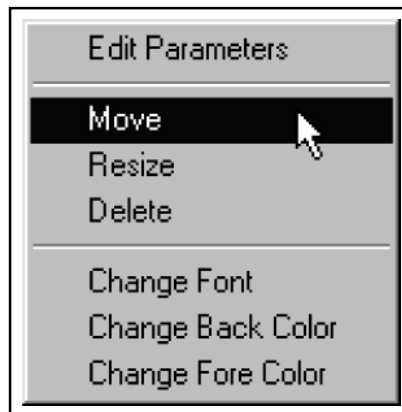

"Change Font" "Change Back color" and "Change Fore Color", are used for the labels (label).

To insert a label (label) in order to recognize the measurement.

- 1) Choose "Add Label" from the "Add control" menu.
- 2) Select the same measurement chosen formerly: PJ500 FWD Power.
- 3) 3. Press the "Ok button".

The result will be as follows:

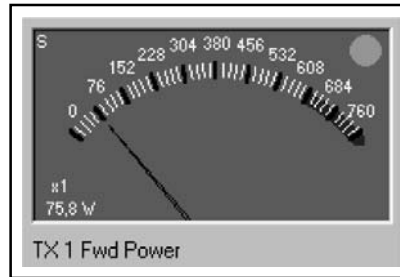

How to insert a led to indicate the presence of an SWR alarm.

- 1) From the menu "Add Control" select "Add Led".
- 2) 2. Select the module PJ500 in box "A".
- 3) 3. Among the "B" buttons, click on "InAna".
- 4) In box "C" choose the measurement "011 (D) TX1 SWR". Make sure the type of input selected is (D) which means it is digital.

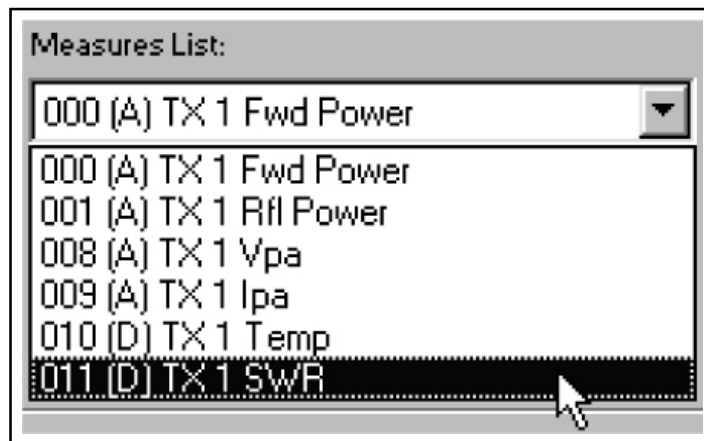

5) It is now possible to select the colour of the led in function of the status of the input:

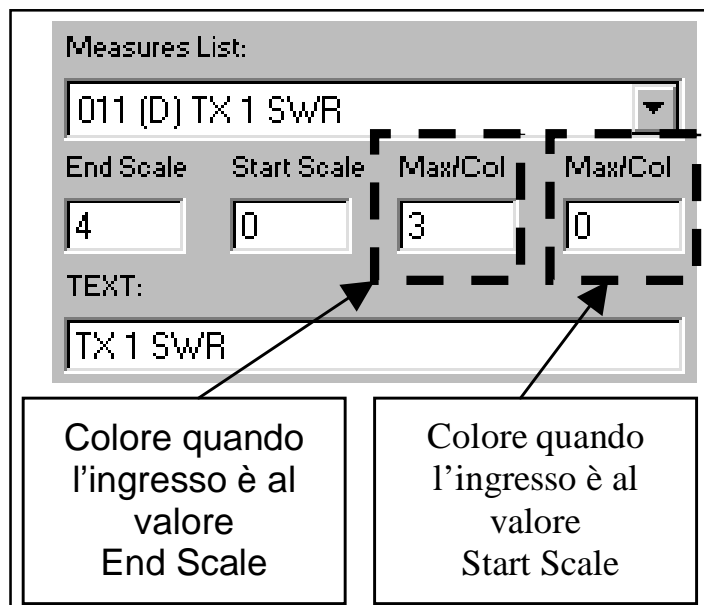

The available colours are five:

- 0 - Black.
 - 1 - Red.
 - 2 - Yellow.
 - 3 - Green.
 - 4 - Blue.
- 6) Press the "Ok" button.
 - 7) If necessary, position the led in the place required.
 - 8) Repeat the same procedure in order to insert a label with the name of the alarm.

We will now create two buttons to switch on and off the transmitter.

- 1) In the "Add Control" menu select "Add Pushbutton "On Type".
- 2) Scegliere il modulo PJ500 dalla casella "A"
- 3) Among "B" buttons select "OutDig".
- 4) In box "C" select the measurement "000 (>) TX1 On".
- 5) In the "Text:" box, enter the name that will be displayed on the button.

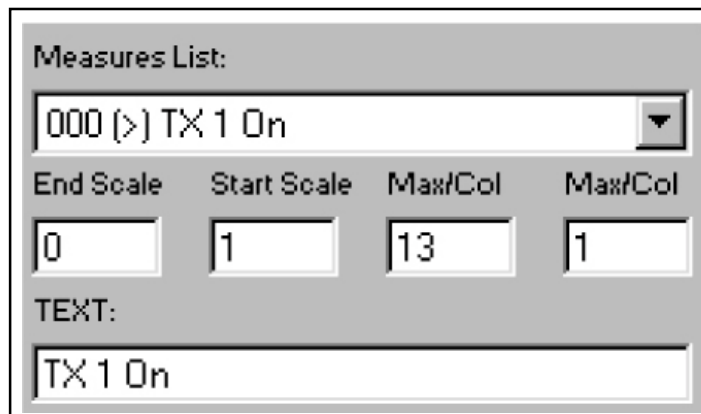

Measures List:			
000 (>) TX 1 On			
End Scale	Start Scale	Max/Col	Max/Col
0	1	13	1
TEXT:			
TX 1 On			

- 6) Press the "Ok" button.
- 7) If necessary, re-position or change the dimensions of the button.
- 8) In the "Add Control" menu select "Add Push button "Off Type"
- 9) Among "B" buttons select "OutDig".
- 10) In the box "C" select the measurement "001 (>) TX1 Off
- 11) In the "Text:" box, enter the name that will be displayed on the button.
- 12) Press the "Ok" button.
- 13) If necessary re-position or change the dimension of the button.

The personalization should be as follows:

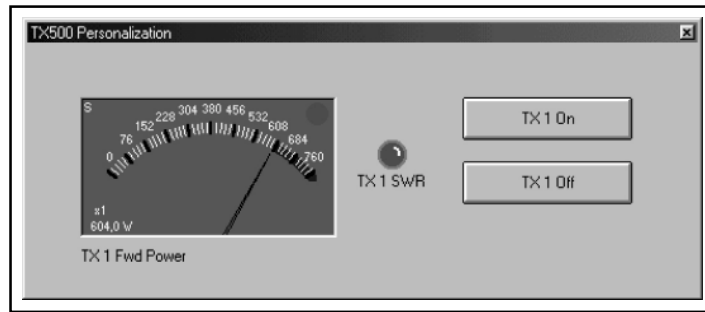

Now you just have to save the window by clicking on the right button of your mouse and choosing "Save Window".

This page was intentionally left blank

2. Monitoring Telemetry Stations

2.1 Functioning

This is a telemetry software that gives the possibility to call automatically and cyclically every station from a list of stations, having their status displayed in a very simple and clear way and indicating which station is in alarm and the type of alarm.

Moreover, it is possible to have the software calling a station after having been informed by an SMS, and have its status displayed immediately.

2.2 Installation

- Insert the CD-ROM in the CD-ROM player.
- From the desktop, open "Program Manager".
- Double click on the CD-ROM player to visualize its content.
- Double click on the program Tlc32bit.exe in order to set up the installation.

It may be required to install the drivers which are necessary for the access to data, before installing the software.

- When the installation is completed, the "Tlc32bit" group which contains the programs: "Telecon 32bit" and "GSM Init" will be created, after which the connection icons will appear on the Desktop.

Required systems:

- Operational system:
Windows 95 ®, Windows 98 ® either first or second edition, Windows ME ®.
The software does not work under Windows NT ® and Windows 2000 ®.
- Processor:
Intel Pentium ® 75 MHz or better.
- Minimum Memory required:
32MB Ram.
- Minimum capacity on Hard Disk required:
Minimo 50Mb.

2.3 Telemetry software

As you can see on the image, the telemetry software is composed of three main windows:

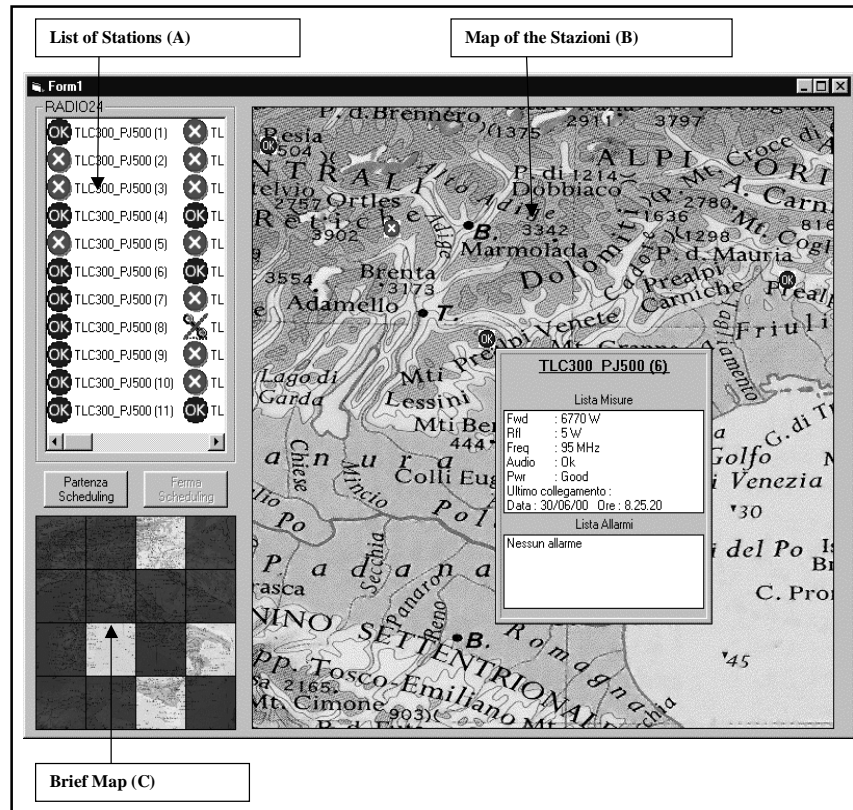

2.3.1 List of Stations (A).

In this list all the stations that concern a customer are displayed.

They are sorted in the following way: presence on the map, priority, frequency of calls and station number in the database.

When positioning your mouse on a station, it is automatically centered in the map (B), and the station will start flashing.

2.3.2 Map of the stations (B).

The position of the stations and their status are displayed. Such map must be built by the user simply by dragging the required stations (taken from the list of stations (A)) to their locations on the map. Once the station is positioned, the schedule monitoring window is displayed. The station will have a different icon in function of the alarms status.

When positioning the cursor on one of these icons a window displays the last parameters and alarms registered, if received.

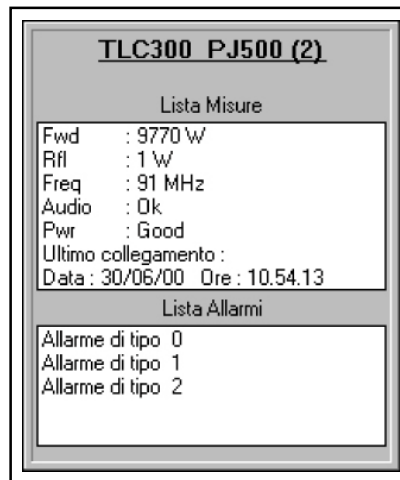

When clicking with the right button of your mouse on the icon indicated above, a cascade menu will display the following functions:

When selecting " Call Station " the immediate call will be made and the consequent data will be updated.



When selecting "Reset Station" you can make an attempt to reset the functioning conditions in case of alarm.



When choosing "Telecon" you can call the station with the normal telemetry software in order to get more detailed information (for expert users).



When choosing " Properties" a sub-menu with 2 possible choices is displayed:

" Scheduling Manager" which displays a window for the setting of scheduling parameters and priority calls. Such priority will also be used put the stations in order in the list (A);

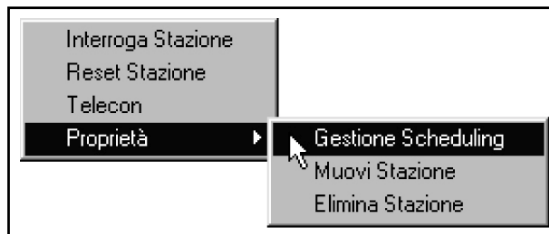

"Move Station" is used to re-position the station on the map.

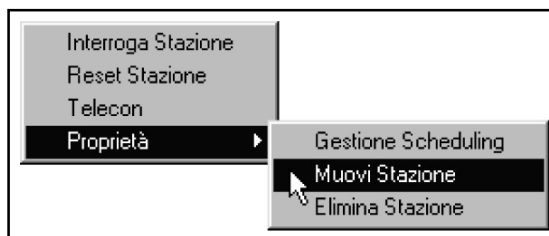

"Cancel Station" is used to cancel the station from the map (but not from the database).

When moving the mouse having the left button pressed, you can scroll the geographic map.

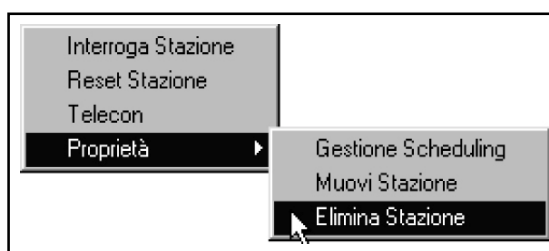

2.3.3 Brief Map (C).

Such map is a reference for the Stations location (B). Basically, it is the same map, but reduced and divided into 16 quadrants. Such quadrants enable a selection of only the required part of the country, since it is impossible to show the whole map in a defined way. Apart from that, in case of alarm the quadrant where the station is situated will be coloured in red to indicate an anomalous situation. In this way it is possible to keep under control the status of all the stations without needing to move the mouse.

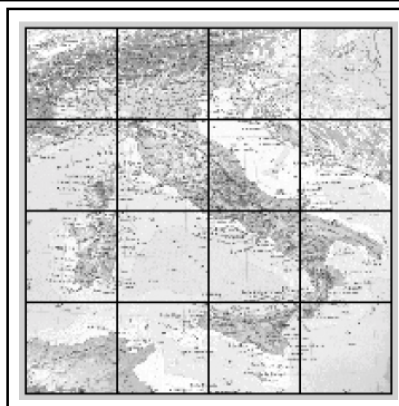

2.4 Scheduling functions

The Scheduling is structured in the following way:



Gestione Scheduling
TLC300_PJ500 (1)

Priorità: (Min Med Max)

N° tentativi: 2 Illimitato

Inizio Scheduling: Tre volte al giorno

Conferma Annulla

- 1) The parameters that can be modified in the station are:
 - Frequency of the calls, being possible to choose among the following values:
 - 1 - 3 times a day (morning, afternoon and evening)
 - 2 - once a day, morning
 - 3 - once a day, afternoon
 - 4 - once a day, evening
 - 5 - 3 times a week
 - 6 - once a week
 - 6 - once a month
 - 8 - Never

- Priority. The priority will be selected through a slider having three positions (high, medium, low) that the customer may use to set the order in which calls should be made. Basically, if some stations are more important than others, it will be necessary to assign to this station a priority higher than the priority of other stations. When the system starts making the calls, it will first call the higher priority stations, then medium and so on... This choice in priorities also influences the order in which the stations are displayed in the List (A).
- Number of attempts. It is possible to set a number of attempts "retry" from 1 to 99 + ∞ which represent the number of attempts that the program must make before the station is considered as disconnected, therefore before communication alarms are released. If you choose ∞ the software will try to make the connection until he succeeds to.

All the other call parameters, telephone number etc., are copied from the Telecon database.





The stations are put in order in the list (A) for:

- Presence on the map,
 - priority
 - frequency of calls,
 - identification number in the Telecon database
- 2) The two buttons: "Start Scheduling" and "Stop Scheduling" are used to start or to interrupt the automatic procedure of calls. In this way if the user wants to call a station manually (while the cycle is started), he will have to set the software on "Stop Scheduling", then wait that the actual call is completed (if there is a call being made) and therefore he will be able to make the call by selecting the proper icon with the mouse on the cascade menu. It would be appropriate to insert a password for the selection from automatic to manual mode so that only the specialized technician has access to such operation. Anyway the software should always start in Automatic mode.
 - 3) In automatic mode the software starts from the first station of the List (A), and so on until the last one (N.B. ONLY the stations that are present on the map are called). Once the list is finished, and in function of the number of retries setted, the system calls the stations that did not respond the first time. The software will go on until a response from all the stations is obtained and until there are no retries available.



In case the call cycle is completed before the change of call cycle, the program remains in stand-by; the "Start Scheduling" button changes to "Call Stations".

In this way it is possible to have the program making an additional cycle of calls to all the stations without taking into account the last call and without exiting the scheduling cycle.
 - 4) The following 4 symbols indicate the status of the stations:

Where these icons appear:

-  indicates that the station is working correctly.
-  indicates that the station is in alarm.
-  indicates that the maximum number of retries was reached.
-  indicates that the program is making a retry.

There are also three other symbols used in the list (A):

-  indicates that the station is being called (used only in scheduling).
-  indicates that the station has not already been called (used only in scheduling)
-  indicates that the station is not present in the map.

Apart from the normal parameters displayed (Power, frequency etc.) there will also be the time and date of the last connection.

- 5) 5. When the scheduling cycle is operational, the following functions are not available:
- dragging of stations to the map
 - positioning of the stations from the list (A) to the map
 - - the menu selected with the right button of the mouse is not available, except the scheduling configuration window that can be seen but not modified.

2.5 Technical information concerning the realization

For the realization of this software we have used the telemetry software (TELECON) with an additional new window..

The basic communication structure of the software remains the same and all the functions of Telecon remain unchanged. Except this new window and the database of the customer filled with the data present in the Telecon PHBOOK directory.

In such database the user may add new areas and tables in function of the following criteria:

- A. Five new areas were added to the Phone_Book table of the database:
- 1) Presence of the station on the map and therefore also the presence of the scheduling automatic procedure.
 - 2) Name of the table where the registered data and scheduling parameters are entered.
 - 3) Priority number of such station.

The area 3 will be used in order to define the position of a given station in the list (A) and therefore the order for the automatic calls.

4) Frequency of station calls according to the scheme:

0 - 3 times a day (morning, afternoon and evening)

1 - once a day, morning

2 - once a day, afternoon.

3 - once a day, evening.

4 - 3 times a week

5 - once a week.

6 - once a month.

7 - Never.

5) Date of the beginning of the scheduling

B. Configuration tables of the stations. Basically for each station present in the Table Phone_Book, there will be 2 corresponding tables having a name with progressive initials that will refer to the station situated in the area formerly described. The name of the two stations will start with a different suffix in order to identify them:

"_sto" for the table where the data received by the remote station are stored,

"_cfg" for the table where the scheduling configuration data are registered.

The following areas are present in these tables:

Table "_cfg"

1) Position X on the map. (Single)

2) Position Y on the map. (Single)

3) Data Start Scheduling

4) Start Time of Scheduling

5) Number of Retry from 1 to 99, with 0 indicating "unlimited"

6) Date of the last connection

7) Time of the last connection

8) Status of the station during the last connection:

0 - OK - Station functioning correctly.

1 - COM - Communication problem (when maximum number of retry is reached)

2 - RETRY - Station making a Retry.

3 - FAULT - Station in Alarm.

Table "_sto"

1) String received with data.

- 2) String received with alarms.
- 3) Byte indicating the number of alarms present.
- 4) Date of the last connection.
- 5) Time of the last connection.
- 6) Status of the station at the last connection (see point 8)

Each station present in the Phone_Book table will have a corresponding configuration table as shown in point B.

Each time the software will restart these data will be loaded and displayed.

This page was intentionally left blank

3. Interconnection example (TLC)

3.1 In Digital with RVR's LCD Equipment

In the case of connection between the TLC system and digital equipment exclusively using the digital input on bus Ilc must respect some sagacities:

- PTX-LCD excitors serie must have always the lower addresses.
- The coupler HC-LCD serie, in order of addresses after the excitors, must have Type = 133.
- The amplifiers will follow all then.

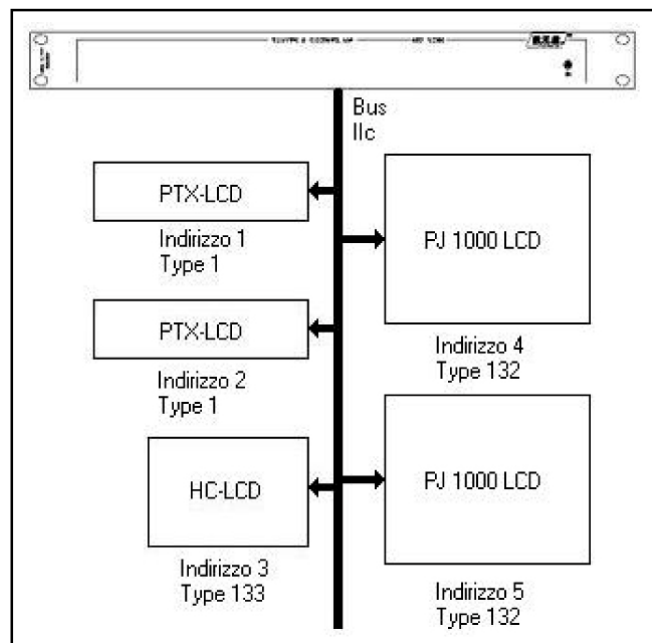

The Type that identified the digital cards are described in the following table:

Type	Nome
0	None
1	PTX30LCD
2	SCM4
3	TLC300/2000
4	SCM1
5	PTX60LCD
6	PTX100LCD
7	TLC tube
8	PTRL NV
9	RXRL NV
129	Telemetry card type 1
130	Telemetry card type 2
131	Telemetry card type 3
132	Mosfet Protection
133	Hc Primary
134	Hc Simple

3.2 In Analogic with RVR's LCD Equipment

To connect different RVR' base equipment between they, that aren't digital, is necessarily use an IB (see accessories), that allows the redistribution of the signals them coming from the equipment in order to make them to reach in right way on the inputs of the TLC.

All the connections between the devices come made through standard parallels cables, connecting between the IB and the equipment the outputs that have the same label:

- Service -> Service
- Telemetry -> Telemetry

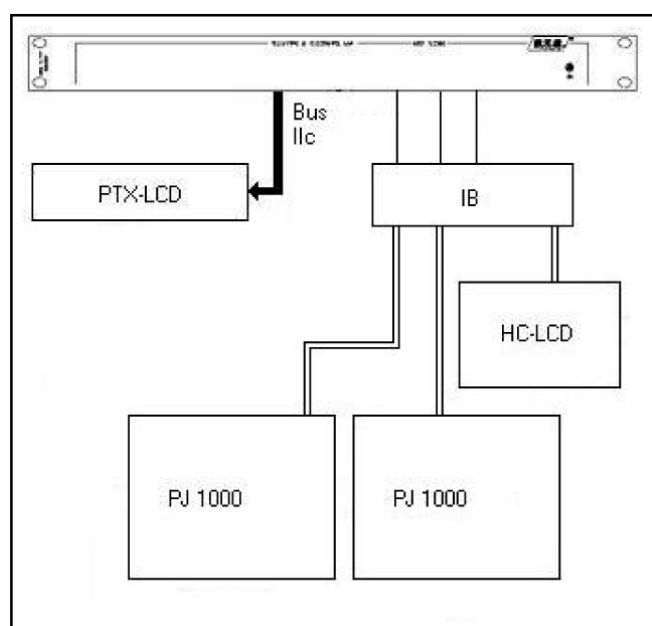

3.3 In Analogic with Generic Equipment

In this case it must resort to the connection tables, remembering that the balanced inputs are operative with not greater tensions of 12V while those digitals arrive to the maximum to 5V.

The tensions must be in continuum current.

3.3.1 How to control a D.C.voltage superior to 5V

Connect to DB25 marked as BALANCED ANALOG INPUT on the PIN described in the table

Pin number	Meant	Adj. Trimmer
2 (+), 14 (-)	Analogic balanced input n°1	RV1
3 (+), 16 (-)	Analogic balanced input n°2	RV2
5 (+), 17 (-)	Analogic balanced input n°3	RV3
6 (+), 19 (-)	Analogic balanced input n°4	RV4
8 (+), 20 (-)	Analogic balanced input n°5	RV5
9 (+), 22 (-)	Analogic balanced input n°6	RV6
11 (+), 23 (-)	Analogic balanced input n°7	RV7
12 (+), 25 (-)	Analogic balanced input n°8	RV8
1, 4, 7, 10, 13, 15, 18, 21, 24	Massa	

Obtain the maximum of the voltage and regulate the correspondent trimmer in order to obtain the visualization, on the remote control software, the voltage of 5V. See the software manual to set up correctly the database necessary to have an immediate visualization of the parameter in the right unit of measure.

3.3.2 How to control a voltage inferior to 5V

Connect to DB25 marked as DIGITAL/ANALOG INPUT on the PIN described in the table:

Pin number	Meant	Jumper su JP4
2	Digital/analogic unbalanced input n°1	pos. 1
15	Digital/analogic unbalanced input n°2	pos. 2
3	Digital/analogic unbalanced input n°3	pos. 3
16	Digital/analogic unbalanced input n°4	pos. 4
4	Digital/analogic unbalanced input n°5	pos. 5
17	Digital/analogic unbalanced input n°6	pos. 6
5	Digital/analogic unbalanced input n°7	pos. 7
18	Digital/analogic unbalanced input n°8	pos. 8
21	Digital/analogic unbalanced input n°9	pos. 9
9	Digital/analogic unbalanced input n°10	pos. 10
22	Digital/analogic unbalanced input n°11	pos. 11
10	Digital/analogic unbalanced input n°12	pos. 12
23	Digital/analogic unbalanced input n°13	pos. 13
11	Digital/analogic unbalanced input n°14	pos. 14
24	Digital/analogic unbalanced input n°15	pos. 15
12	Digital/analogic unbalanced input n°16	pos. 16
1, 6, 7, 8, 13, 14, 19, 20, 25	GND	

Obtain the visualization, on the remote control software, of the parameter. See the software manual to set up correctly the database necessary to have an immediate visualization of the parameter in the right unit of measure.

3.3.3 How use the relay outputs

Remembering that in figure is represented schematically the Off relay condition and that the disposition of the contacts in the connector is described in the following table.

Pin number	Meant
1 (C), 14 (NC), 2 (NO)	Relay n°1
15 (C), 3 (NC), 16 (NO)	Relay n°2
4 (C), 17 (NC), 5 (NO)	Relay n°3
18 (C), 6 (NC), 19 (NO)	Relay n°4
7 (C), 20 (NC), 8 (NO)	Relay n°5
21 (C), 9 (NC), 22 (NO)	Relay n°6
10 (C), 23 (NC), 11 (NO)	Relay n°7
24 (C), 12 (NC), 25 (NO)	Relay n°8
13	GND

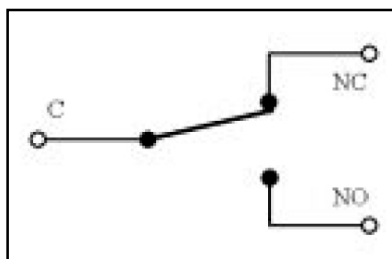

The maximum current that could be made flow through the contacts is of 500mA to 24V.

See the manual of the software to move the relay and set up the necessary database correctly to have the operationing of the relay adjusted to the demands.

4. Commands from remote (TLC)

Through these commands sends under form of SMS they could be modified the states of any exits and activate any functions of the TLC.

- INFO: Sending this message as SMS from any mobile phone, you must have in answered an other SMS with the number and name of the station, the forward and reflected power present in percentage and the currents alarms.
- ALARM: Sending this message as SMS from any mobile phone, you must have in answered an other SMS with the number and name of the station, the forward and reflected power present in percentage, name and number of the last 6 alarms currently in memory.
- TXON: Sending this message as SMS from any mobile phone, it moves the relay 1 of the base telemetry card n.1 in TOGGLE_OFF modality and you must have in answered an other SMS message with the number, name of the station and the wording " Comand SMS Ok".
- TXOFF: Sending this message as SMS from any mobile phone, it moves the relay 2 of the base telemetry card n.1 in TOGGLE_OFF modality and you must have in answered an other SMS message with the number, name of the station and the wording " Comand SMS Ok".
- OUTON (out): Sending this message as SMS from any mobile phone, it moves the relay "num", in the programmed formality, of the last telemetry card and you must have in answered an other SMS message with number, name of the station and the wording "Comand SMS Ok".
- OUTOFF (out): Sending this message as SMS from any mobile phone, it moves the relay "num", in the programmed formality, of the last telemetry card and you must have in answered an other SMS message with number, name of the station and the wording "Comand SMS Ok".
- RESET: Sending this message as SMS from any mobile phone, it reset the present alarms in memory and and you must have in answered an other SMS message with number, name of the station and the wording " Comand SMS Ok".

This page was intentionally left blank

5. Messages on the Modem State (only TLC2000)

In this section is described the visualization of the messages state on the display regarding the modem.

These messages could be in the angle aloft to the right of the display, on the frontal panel (only of TLC2000) and they inform on the modem current state.

These messages could be:

- **Init:** Questo messaggio informa che il modem deve ancora essere inizializzato e quindi la procedura di inizializzazione e' ancora in corso.
- **StdBy:** Il modem e' inizializzato ed in attesa di comandi come si può vedere anche dall'apposito LED posto sempre sul pannello frontale.
- **wait:** Questo messaggio informa che il modem sta tentando di eseguire un'operazione di invio messaggio o di connessine con altro modem.
- **NoDia:** Questo messaggio informa che il modem in seguito ad una richiesta di operazione non riesce a comunicare.
- **Init:** This message informs that the modem owes still have initialized and therefore the procedure of initialization is still in course.
- **StdBy:** The modem is inizialized and waiting to orders like it could also be seen from the set relative LED always on the frontal panel.
- **Wait:** This message informs that the modem is trying to perform an operation of dispatch message or of connection with other modem.
- **NoDia:** This message informs that the modem in succession to an application of operation is not able to communicate.
- **?Busy:** This message informs that the modem is busy and it is ignoring the order that comes him given.
- **OkCon:** This message informs that the modem communicates with the outside and is sending a message in SMS or normal form.
- **Send>:** This message informs that the modem the is about to send message.
- **Ok!:** This message informs that the modem has sent the SMS with success.
- **Hang:** (only PSTN) This message informs that the modem is effecting the procedure of Hang up and therefore it is interrupting the communication.

This page was intentionally left blank

Appendix B Piani di montaggio, schemi elettrici, liste componenti / *Component layouts, schematics, bills of material*

Questa parte del manuale contiene i dettagli tecnici riguardanti la costruzione delle singole schede componenti il TLC300. L'appendice è composta dalle seguenti sezioni:

This part of the manual contains the technical details about the different boards of the TLC300. This appendix is composed of the following sections:

Description	RVR Code Pages	Vers.	
CPU SECTION	CSPTCPU55202	1.1	4
POWER SUPPLY	CSSWPSUP0003	1.0	4
Main card TLC SCM	CSTLSCCPU002	1.1	4
Scheda telemetria base 24 input / 8 Relays	CSTLMINP1-01	1.0	4
Scheda TLC (Analogica bilanciata)	CSTLMANABI01	1.0	4
Scheda filtro connettore DB9	CSDB9MFILFL2	1.0	4

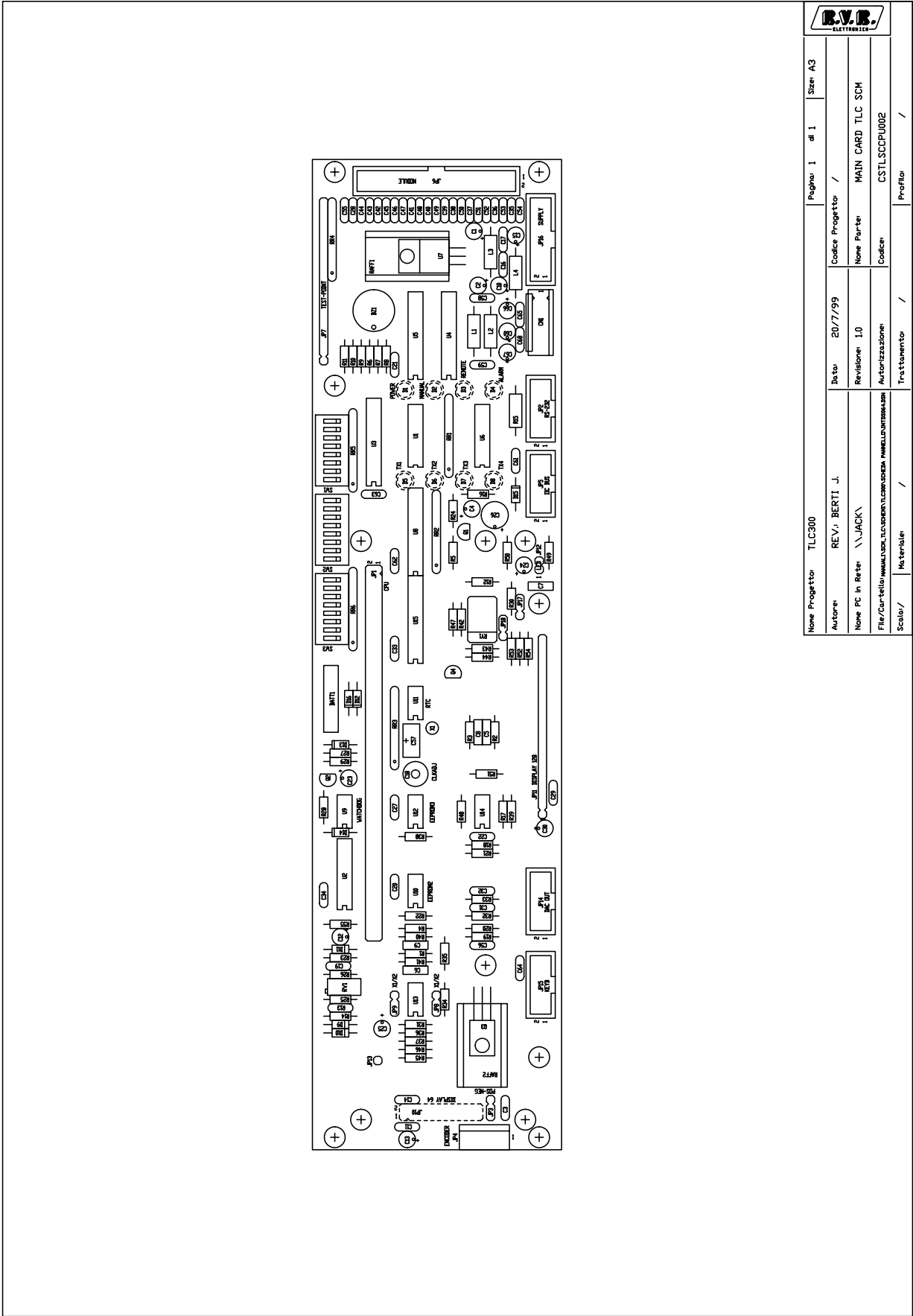

Nome Progetto		TLC300		Pagina 1 di 1		Size: A3	
Autore		REV. BERTI J.		Data		20/7/99	
Nome PC in Rete		\\JACK\		Revisione		I.0	
File/Carrello		\\MAILLUNTRIMBA\MAILLUNTRIMBA\TLC300\PCB\TLC300.PCB		Nome Parte		MAIN CARD TLC SCM	
Scala		Moltiplicabile		Codice		CSTLSCCPU002	
				Trattamento		/	
				Profilo		/	

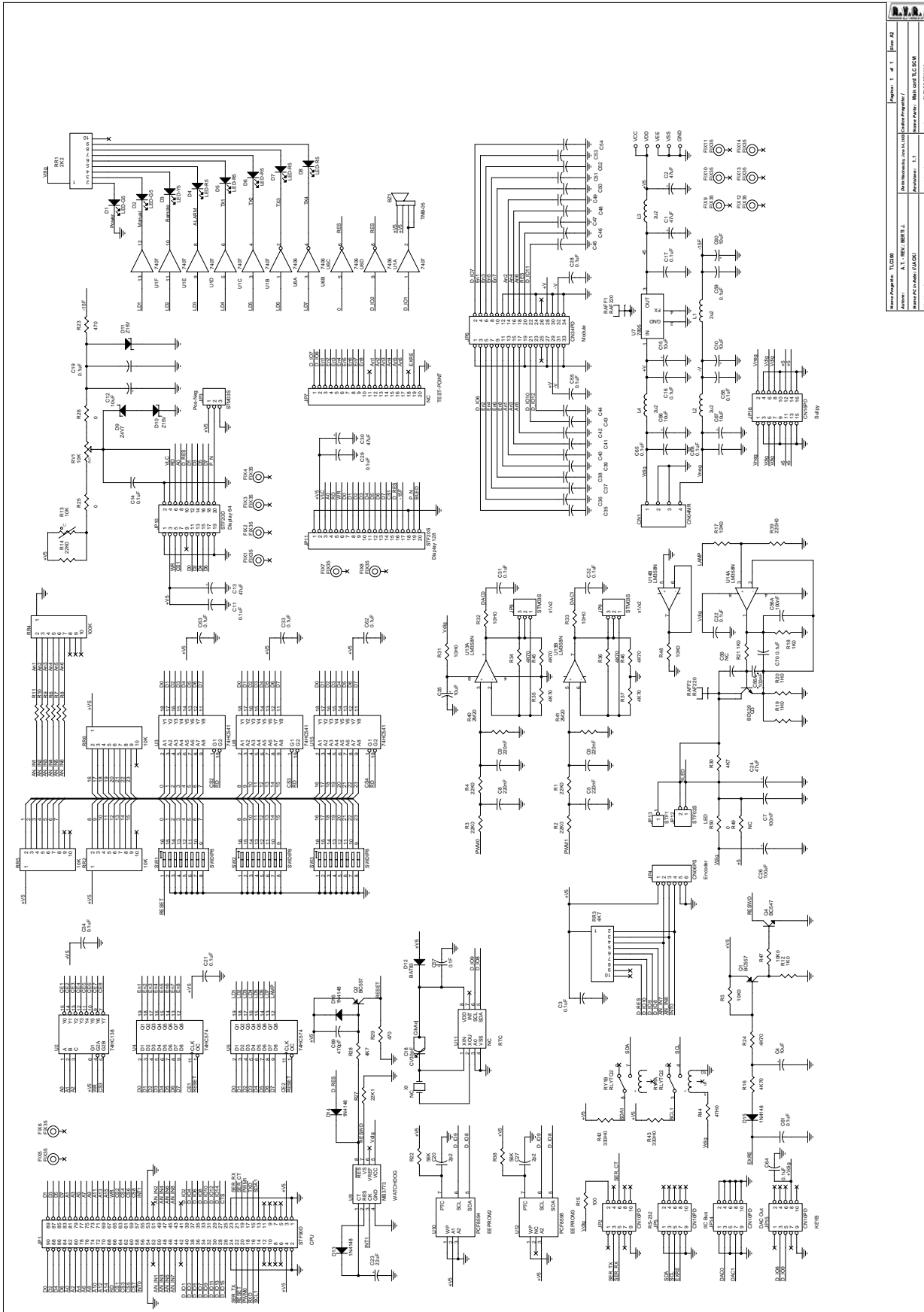

Nome Progetto	TLC300	Versione	1.1
Autore	A.T. R.V.R. BR/3.1	Revisione	1.1
Autore PC/CA/Doc/IT/ACQ	Man. and B.C. SGA	Autore	Man. and B.C. SGA
Autore	Man. and B.C. SGA	Autore	Man. and B.C. SGA
Autore	Man. and B.C. SGA	Autore	Man. and B.C. SGA

Main card TLCSCM Bill Of Materials

Page 1

Item	Quantity	Reference	Part
1	1	BZ1	TMB-05
2	1	CN1	CN04MR
3	5	C1, C2, C13, C24, C30	47uF
4	24	C3, C11, C14, C16, C17, C19, C21, C22, C28, C29, C31, C32, C33, C34, C55, C58, C59, C61, C62, C63, C64, C65, C68, C70	0.1uF
5	8	C4, C10, C12, C15, C25, C60, C66, C67	10uF
6	4	C5, C6, C8, C9	220nF
7	2	C7, C56A	100nF
8	1	C18	CV30pF
9	2	C27, C20	2p2
10	1	C23	22uF
11	1	C26	100uF
12	20	C35, C36, C37, C38, C39, C40, C41, C42, C43, C44, C45, C46, C47, C48, C49, C50, C51, C52, C53, C54	100pF
13	1	C56	4n7
14	1	C57	0.1F
15	1	C69	470pF
16	2	D2, D1	LED-G5
17	1	D3	LED-Y5
18	5	D4, D5, D6, D7, D8	LED-R5
19	1	D9	Z4V7
20	2	D10, D11	Z15V
21	1	D12	BAT83
22	4	D13, D14, D15, D16	1N4148
23	14	FIX1, FIX2, FIX3, FIX4, FIX5, FIX6, FIX7, FIX8, FIX9, FIX10, FIX11, FIX12, FIX13, FIX14	FIX35
24	1	JP1	STF90D
25	4	JP2, JP5, JP14, JP15	CN10PD
26	3	JP3, JP8, JP9	STM03S
27	1	JP4	CN06PS
28	1	JP6	CN34PD
29	4	X1, JP7, U11, R49	NC
30	1	JP10	STF20D
31	1	JP11	STF20S
32	1	JP12	STF02S
33	1	JP13	STF1
34	1	JP16	CN16PD
35	4	L1, L2, L3, L4	2u2
36	2	Q2, Q1	BC557
37	1	Q3	BD139
38	1	Q4	BC547
39	2	RAFF2, RAFF1	RAF220
40	1	RR1	2K2
41	5	RV1, RR2, RR5, RR6, R13	10K
42	3	RR3, R28, R30	4K7
43	1	RR4	100K
44	1	RY1	RLYTQ2

45	5	R1, R2, R3, R4, R14	22K0
46	4	R5, R17, R47, R48	10K0
47	9	R6, R7, R8, R9, R10, R11, R12, R18, R21	1K0
48	1	R15	100
49	8	R16, R24, R34, R35, R36, R37, R45, R46	4K70
50	2	R19, R20	1H0
51	2	R38, R22	56K
52	2	R23, R29	470
53	3	R25, R26, R50	0
54	1	R27	22K1
55	3	R31, R32, R33	10H0
56	1	R39	220H0
57	2	R40, R41	2M20
58	2	R42, R43	330H0
59	1	R44	47H0
60	3	SW1, SW2, SW3	SWDIP8
61	1	U1	7407
62	1	U2	74HC138
63	3	U3, U8, U15	74HC541
64	2	U4, U5	74HC574
65	1	U6	7406
66	1	U7	7805
67	1	U9	MB3773
68	1	U10	PCF8594
69	1	U12	PCF8598
70	2	U14, U13	LM358N