

TECHNICAL AND MANTEINANCE MANUAL

VJ10000-TR

10KW Power Triode Amplifier 87.5-108 MHz



Manufactured by R.V.R. Elettronica - Italy

INDEX

I - PRELIMINARY INSTRUCTIONS AND WARRANTY INFORMATION.....	6
II - TUBE WARRANTY INSTRUCTIONS.....	8
VARIAN POWER GRID PRODUCT LIMITED WARRANTY	8
III – SAFETY REGULAMENT!	9
<i>WARNING!</i>	9
TREATMET OF ELECTRICAL SHOCK.....	10
FIRST-AID.....	12
<i>TREATMENT OF ENECTRICAL BURNS</i>	12
<i>NOTE</i>	12
CHAPTER 1.....	13
VJ10000-TR GENERAL DESCRIPTION	13
1.1 <i>MECHANICAL DESCRIPTION</i>	13
1.2 <i>ELECTRICAL DESCRIPTION</i>	13
1.3 <i>TECHNICAL SPECIFICATIONS</i>	13
CHAPTER 2.....	14
ELECTRICAL DESCRIPTION	14
2.1 <i>INTRODUCTION</i>	14
CHAPTER 3.....	33
EQUIPMENT INSTALLATION	33
3.1 <i>INTRODUCTION</i>	33
3.2 <i>UNPACKING</i>	33
3.3 <i>TUBE INSTALLATION</i>	35
3.4 <i>EQUIPMENT SETTING AT WORK</i>	44
CHAPTER 4.....	46
TUBE MEASURES CARD CALIBRATION	46
4.1 <i>NOTICE</i>	46
4.2 <i>INTRODUCTION</i>	46
4.3 <i>MEASURES CARD ADJUSTING OPERATIONS</i>	50
CHAPTER 5.....	60
MAINTENANCE.....	60
5.1 <i>SAFETY RULES</i>	60
MAINTENANCE FIRST LEVEL	60
5.2 <i>SAFETY RULES</i>	60
MAINTENANCE SECOND LEVEL	60
5.3 <i>MODULES REPLACING</i>	60
5.4 <i>TUBE REPLACING</i>	61
5.5 <i>AIR FILTER REPLACING</i>	61
CHAPTER 6.....	62
ADJUSTMENTS.....	62
6.1 <i>FREQUENCY CHANGE</i>	62
APPENDIX A.....	62
CIRCUIT DIAGRAMS AND LAYOUTS.....	62

PICTURES

FIG. 1	FRONTAL VIEW	15
FIG. 2	REAR VIEW	16
FIG. 3	UPPER VIEW	17
FIG. 4	HINGED FRONTAL PANEL WITH TELEMETRY	18
FIG. 5	HINGED FRONTAL PANEL WITHOUT TELEMETRY	20
FIG. 6	HIGH VOLTAGE PANEL	21
FIG. 7	P1 POWER SUPPLY SECTION VIEW	22
FIG. 8	P2 POWER SUPPLY SECTION VIEW	23
FIG. 9	R.F. CAVITY FRONTAL VIEW	25
FIG. 10	R.F. CAVITY FRONTAL VIEW	27
FIG. 11	TUNING MOTORIZED MECHANISM VIEW	28
FIG. 12	R.F. CAVITY TOP VIEW	29
FIG. 13	R.F. CAVITY LEFT LATERAL VIEW	30
FIG. 14	R.F. CAVITY RIGHT LATERAL VIEW	31
FIG. 15	REAR VIEW	32
FIG. 16	TUBE INSTALLATION DIAGRAM N°1	36
FIG. 17	TUBE INSTALLATION DIAGRAM N°2	37
FIG. 18	TUBE INSTALLATION REFERENCE VIEW N°2	38
FIG. 19	TUBE INSTALLATION DIAGRAM N°3	39
FIG. 20	TUBE INSTALLATION REFERENCE VIEW N°3	40
FIG. 21	TUBE INSTALLATION REFERENCE VIEW N°4	41
FIG. 22	TUBE INSTALLATION REFERENCE VIEW N°4	42
FIG. 23	REGOLAZIONE RF - MHZ	43
FIG. 24	MEASURES CARD REFERENCE VIEW	47
FIG. 25	MEASURES CARD REPLACING DIAGRAM N°1	48
FIG. 26	MEASURES CARD REPLACING DIAGRAM N°2	49
FIG. 27	POWER SUPPLIES CONNECTION FOR THE CALIBRATION OF TEST POINT VOLTAGES	53
FIG. 28	REPORT MEASURE	58
FIG. 29	POWER SUPPLY SOCKET	63
FIG. 30	ANODE TENSION TRANSFORMER SOCKET	64
FIG. 31	RACK POWER SUPPLY BASE	65
FIG. 32	HIGH TENSION PANEL	66
FIG. 33	ELECTROMECHANICAL PLANE (TRIODE)	67
FIG. 34	RESISTENZE DI SOFT-START E POLARIZZAZIONE VALVOLA	70
FIG. 35	TUBE AMPLIFIERS PROTECTIONS CARD	71
FIG. 36	HIGH POWER RELAYS CARD	72
FIG. 37	TUNING RELAYS CARD	73
FIG. 38	TELEMETRY INTERFACE CARD	74
FIG. 39	MEASURES CALIBRATION CARD	75
FIG. 40	THERMAL STROBE CONNECTOR	76
FIG. 41	P.W.R. MEASURE CONNECTOR	77
FIG. 42	I2 CBUS CONNECTOR FOR TELEMETRY BOX	78
FIG. 43	PTXLCD CONNECTOR	79
FIG. 44	LOW VOLTAGE CIRCUIT DIAGRAM	80
FIG. 45	THREE-PHASES CIRCUIT DIAGRAM	81
FIG. 46	MEASURES AND ALLARMS CIRCUIT DIAGRAM	82
FIG. 47	ELECTRIC SCHEMES	83

TABLES

TABLE A - ELECTRICAL SPECIFICATIONS	13
TABLE B - MECHANICAL AND ENVIROMENTAL SPECIFICATIONS	14
TABLE C - RIFERIMENTO FREQUENZE	43

TABLE D - MEASURE TESTS CARD 54
TABLE E - QUIESCENT WORKING PARAMETERS..... 59
TABLE F - ADVISABLE EQUIPMENT FOR TEST 59
TABLE G - VOLTAGE STABILIZER PARAMETERS..... 59

I - PRELIMINARY INSTRUCTIONS AND WARRANTY INFORMATION

Please observe safety precautions when handling this unit. This equipment contains dangerous currents and high voltages.

This manual is written as a general guide for those having previous knowledge and experience with this kind of equipment. It is not intended to contain a complete statement of all safety warnings which should be observed by personnel in using this or other electronic equipment.

R.V.R. doesn't assume responsibility for injury or damage resulting from improper procedures or practices by untrained/unqualified personnel in the handling of this unit.

Please observe all local codes and fire protection standards in the operations of this unit.

CAUTION: always disconnect power before opening covers or removing any part of this unit. Use appropriate grounding procedures to short out capacitors and high voltage points before servicing.

Any damage to the goods must be reported to the carrier in writing on the shipment receipt. Any discrepancy or damage discovered subsequent to delivery, shall be reported to **R.V.R.** within five (5) days from its receipt.

R.V.R. extends to the original end-user purchaser all original manufacturers warranties which are transferable and all claims are to be made directly to **R.V.R.** per indicated procedures.

All manufacturers warranties will be supported by **R.V.R.** to ensure precise and speedy service where possible.

R.V.R. shall not be liable for any damage of whatsoever nature, arising out of or in connection with the product or its use thereof.

R.V.R.'s warranty shall not include:

- a. Re-shipment of the unit to **R.V.R.** for repair purposes
- b. Any unauthorized repair/modification
- c. Incidental/consequential damages as a result of any defect
- d. Nominal non-incidentals defects
- e. Re-shipment costs or insurance of the unit or replacement units/parts

Warranty shall come into force from invoice date and for the period of the manufacturer's warranty.

To claim your rights under this warranty:

- a. Contact the dealer or distributor where you purchased the unit. Describe the problem and ask if he has an easy solution. Dealers and Distributors are supplied with all the information about problems that may occur and usually they can repair the unit quicker than what the manufacturer could do. Very often installing errors are discovered by dealers.
- b. If your dealer cannot help you, contact **R.V.R.** in Bologna and explain the problem. If it is decided to return the unit to the factory, **R.V.R.** will mail you a regular authorization with all the necessary instructions to send back the goods.
- c. When you receive the authorization, you can return the unit. Pack it carefully for the shipment, preferably using the original packing and seal the package perfectly. The customer always assumes the risks of loss (i.e., **R.V.R.** is never responsible for damage or loss), until the package reaches **R.V.R.** premises. For this reason, we suggest you to insure the goods for the whole value. Shipment must be effected C.I.F. (PREPAID) to the address specified by **R.V.R.**'s service manager on the authorization.

DO NOT RETURN UNITS WITHOUT OUR AUTHORIZATION AS THEY WILL BE REFUSED.

Be sure to enclose a written technical report where mention all the problems found and a copy of your original invoice establishing the starting date of the warranty.

Replacement and warranty parts may be order from the following address. Be sure to include the equipment model and serial number as well as part description and part number.

R.V.R. Elettronica S.p.a. - Broadcasting Equipment -
Via del Fonditore, 2/2c
Zona Roveri
40138 Bologna - Italy
International Phone: +39 - 51 - 6010506
FAX Number: +39 - 51 - 6011104

R.V.R. reserves the right to modify the design and specifications of the equipment in this manual without previous

II - TUBE WARRANTY INSTRUCTIONS

VARIAN POWER GRID PRODUCT LIMITED WARRANTY

Varian products are warranted to be free from defects in workmanship and materials only. The warranty involves both calendar time and filament (or heater) operation time. Specifically involved are: time since the product was shipped from Varian time since delivery to the user, and operation time.

WHICHEVER ELAPSES FIRST CONCLUDES THE WARRANTY.

The warranties are determined by the codes shown in the price schedule.

	TIME SINCE SHIPMENT	TIME SINCE SHIPMENT	TIME SINCE HEATER-ON
Code	from EIMAC	To The User	Time
T	36 MONTHS	24 MONTHS	10.000 HOURS
R	24 MONTHS	12 MONTHS	5.000 HOURS
P	24 MONTHS	12 MONTHS	4.000 HOURS
N	24 MONTHS	12 MONTHS	3.000 HOURS
K	24 MONTHS	12 MONTHS	1.000 HOURS
L	LIFE TESTED AT FACTORY IN LIEU OF AN OTHER WARRANTY		
12	24 MONTHS	12 MONTHS	

The last category is for hardware or accessory items where only calendar time is involved. An Original Equipment Manufacturer (OEM) or an authorized Varian Distributor can hold an item in his stock for 12 months and the end user still receive full warranty. As an example, warranty code T is for 36 months from the date of the shipment from EIMAC, or 24 months from the date of delivery to the user, or 10.000 hours of filament-on time, whichever elapses first.

A product which fails (because of faulty workmanship or materials) in the first 10% of the warranty-time hours will be either replaced at no charge by Varian or 100% of the purchase price will be credited through the original authorized Varian Distributor or OEM. If a failure occurs in the remaining 10-100% of the warranty time hours a prorated adjustment will be calculated and credit issued. This can only be done through the original OEM or authorized Varian Distributor

A prorated credit is calculated as follows:

$$\frac{\text{Warranty (hours)} - \text{Use Time (hours)}}{\text{Warranty (hours)}} = \% \text{ Credit}$$

Thus for failure Code N (3000 hours) if failure occurred after 600 hours and was found to be workmanship or materials related:

$$\frac{3000 - 600}{3000} = 80\%$$

Tubes being returned on a warranty claim are normally sent to authorized Varian distributor or OEM from whom originally purchased. If returned directly to the Varian plant of manufacture, the authorized Varian Distributor or OEM from whom purchased should be notified in case there are some special instructions.

All products returned on a warranty claim must be shipped via prepaid freight and include a completed copy of a service report form, a copy of which is included with every shipped product. A warranty claim cannot be processed without this form. A copy of the original invoice, bill of sale, or other purchase document should be included with the executed service report form to establish purchase date and price.

The original Varian shipping carton and packing material should always be used for any warranty claim return. Shipping damage because of poor packing will normally preclude any warranty adjustment since the damage will usually make any testing or measurements impossible.

PARCEL POST SHOULD NEVER BE USED FOR SHIPMENT OF TUBES.

III – SAFETY REGULAMENT!

WARNING!

The currents and voltages in this equipment are dangerous! Personnel must at all times observe safety regulation!.

This manual is intended as a general guide for trained and qualified personnel who are aware of the dangers inherent in handling potentially hazardous electrical and electronic circuits.

It is not intended to contain a complete statement of all safety precautions which should be observed by personnel in using this or other electronic equipment.

The installation, operation, maintenance and service of this equipment involves risks both to personnel and equipment, and must be performed only by qualified personnel exercising due care. **R.V.R. ELETTRONICA s.p.a.** shall not be responsible for injury or damage resulting from improper procedures or from the use of improperly trained or inexperienced personnel performing such tasks.

During installation and operation of this equipment, local building codes and fire protection standards must be observed.

WARNING!

Always disconnect power before opening covers, doors, enclosures, gates, panels or shields. Always use grounding sticks and short out high voltage points before servicing. never make internal adjustments, perform maintenance or service when alone or when fatigued.

Do not remove, short-circuit or tamper with interlock switches on access covers, doors, enclosures, gates, panels or shields.

Keep away from live circuits, know your equipment and don't take chances.

WARNING!

In case of emergency ensure that power has been disconnected.

TREATMET OF ELECTRICAL SHOCK

1) If victim is not responsive follow the A-B-C's of basic life support.

PLACE VICTIM FLAT ON HIS BACK ON A HARD SURFACE

A) *AIRWAY*

IF UNCONSCIOUS,
OPEN AIRWAY

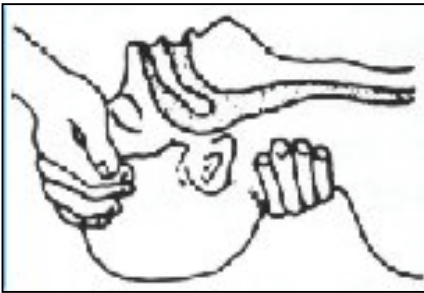

LIFT UP NECK, PUSH,
FOREHEAD BACK,
CLEAR OUT MOUTH IF
NECESSARY, OBSERVE
FOR BREATHING.

B) *BREATHING*

IF NOT BREATHING, BEGIN
ARTIFICIAL BREATHING



TILT HEAD PINCH NOSTRILS,
MAKE AIRTIGHT SEAL, 4 QUICK
FULL BREATHS. REMEMBER
MOUTH TO MOUTH
RESUSCITATION MUST BE
COMMENCED AS SOON AS
POSSIBLE.

C) *CIRCULATION*

CHECK CAROTID PULSE

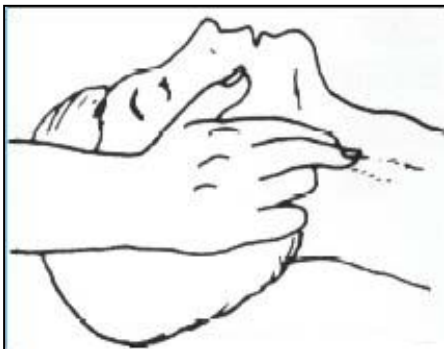

IF PULSE ABSENT, BEGIN
ARTIFICIAL CIRCULATION

DEPRESS STERNUM 1 1/2" TO 2"

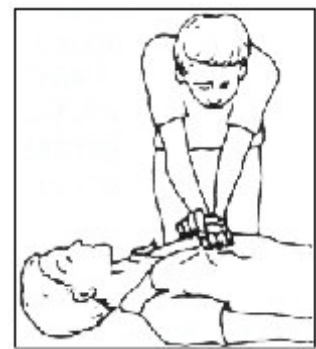
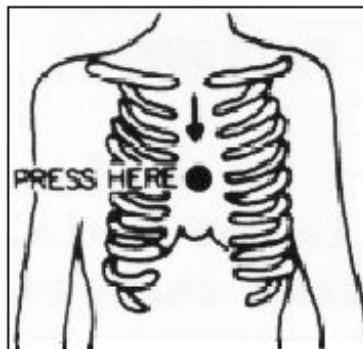

APPROX. 80 SEC. : ONE RESCUER, 15 COMPRESSIONS,
2 QUICK BREATHS.

APPROX. 60 SEC. : TWO RESCUERS, 5 COMPRESSIONS,
1 BREATH

NOTE: DO NOT INTERRUPT RHYTHM OF COMPRESSION WHEN SECOND PERSON IS GIVING BREATH.

Call for medical assistance as soon as possible.

2) If victim is responsive:

- a. Keep them warm.
- b. Keep them as quiet as possible.

c. Loosen their clothing (a reclining position is recommended).

FIRST-AID

Personnel engaged in the installation, operation, maintenance or servicing of this equipment are urged to become familiar with first-aid theory and practices. The following information is not intended to be a complete first-aid procedure, it is brief and is only to be used as a reference. It is the duty of all personnel using the equipment to be prepared to give adequate Emergency First Aid and thereby prevent avoidable loss of life.

TREATMENT OF ELECTRICAL BURNS

1) *Extensive burned and broken skin.*

- a. Cover area with clean sheet or cloth.
(Cleanest available cloth article).
- b. Do not break blisters, remove tissue, remove adhered particles of clothing, or apply any salve or ointment.
- c. Treat victim for shock as required.
- d. Arrange transportation to a hospital as quickly as possible
- e. If arms or legs are affected keep them elevated.

NOTE

If medical help will not be available within an hour and the victim is conscious and not vomiting, give him a weak solution of salt and soda: 1 level teaspoonful of salt and 1/2 level teaspoonful of baking soda to each quart of water (neither hot or cold). Allow victim to sip slowly about 4 ounces (half a glass) over a period of 15 minutes. Discontinue fluid if vomiting occurs (Do not give alcohol).

2) *Less severe burns - (1st & 2nd degree)*

- a. Apply cool (not ice cold) compresses using the cleanest available cloth article.
- b. Do not break blisters, remove tissue, remove adhered particles of clothing, or apply salve or ointment.
- c. Apply clean dry dressing if necessary.
- d. Treat victim for shock as required.
- e. Arrange transportation to a hospital as quickly as possible.
- f. If arms or legs are affected keep them elevated.

CHAPTER 1

VJ10000-TR GENERAL DESCRIPTION

1.1 MECHANICAL DESCRIPTION

The VJ10000-TR is allocated in a 19" rack, 40H, 7 of which are free and can be used to insert an exciter, a receiver or any other equipment. Two analog instruments are placed on the hinged frontal panel (FIG. 1) with all other controls and commands.

The rear panel (FIG. 2) hasn't any connectors but only the air input for the cooling blower, completed with the air filter and the hole for power supply and external exciters cables.

A chimney is placed on top section of the rack (FIG. 3) that allows to push out hot air. The antenna connector is placed on the top part too. The type of connector for the output is 1"+5/8 or 3" 1/8 (optional).

1.2 ELECTRICAL DESCRIPTION

The VJ10000-TR is a tube amplifier, with grounded grid configuration, working on the frequency range 87.5-108 MHz.

This amplifier is able to operate at 10KW output power with a driving power of about 500 W. The amplifier has motorized plate, load and input tuning, and is able to cover the completely frequency range. The VJ10000-TR is been projected to use a three-phases mains voltage (monphase only on request).

1.3 TECHNICAL SPECIFICATIONS

See as reference the Table A for electrical specifications and Table B for mechanical and enviromental specifications.

TABLE A - ELECTRICAL SPECIFICATIONS

Alternate mains voltage	Three phases:	220-240V \pm 15%, 50-60 Hz 380-415V \pm 15%, 50-60 Hz
	Mono phase:	220-240V \pm 15%, 50-60 Hz
Frequency Range		87.5 - 108 MHz (other on request)
Output Power		11000 W max, 10000 W typical
RF Output Impedance		EIA 1+5/8" connector, 50 Ohm
RF Input Impedance		N-type connector, 50 Ohm
RF Driving Power		500 W max
Tube		EIMAC 3CX15000A7
Cooling		Forced air cooling
Spurious and harmonics suppression		Exceed or equal to FCC an CCIR requirements
Power consumption		about 18-20 KW

TABLE B - MECHANICAL AND ENVIROMENTAL SPECIFICATIONS

40 HE Rack Dimension	565 mm (22.24") W 850 mm (33.46") D 1894 mm (74.56") H
Panel Dimension	483 mm (19") W 1779 mm (71.11") H
Weight	470 Kg (770 Lbs)
Working extreme temperatures	from -10° to +50°C
Umidity	max 90%, Without condensing

CHAPTER 2

ELECTRICAL DESCRIPTION

2.1 INTRODUCTION

This chapter describes accurately the VJ10000-TR electrical components. For an easy understanding, the equipment is been divided in modules, each of them is described completely as follows.

FIG. 1 FRONTAL VIEW

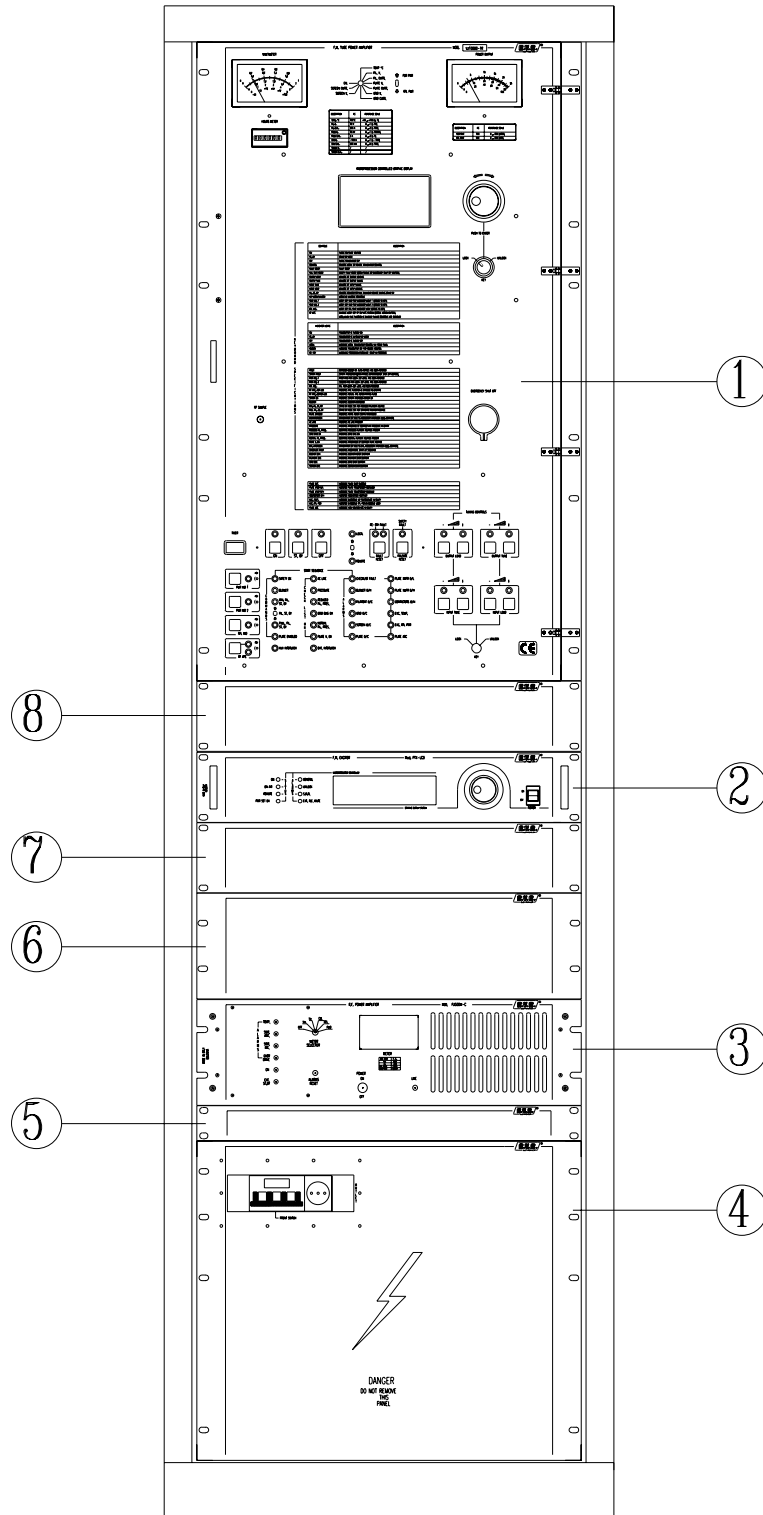

REF.

DESCRIPTION

- 1) Protections panel (18U)
- 2) Exciter (2U)
- 3) Driver (3H)
- 4) High Voltage Panel (9H)
- 5) Free panel (1HE)
- 6) Free panel (3HE)
- 7) Free panel (2HE)
- 8) Free panel (2HE)

FIG. 2 REAR VIEW

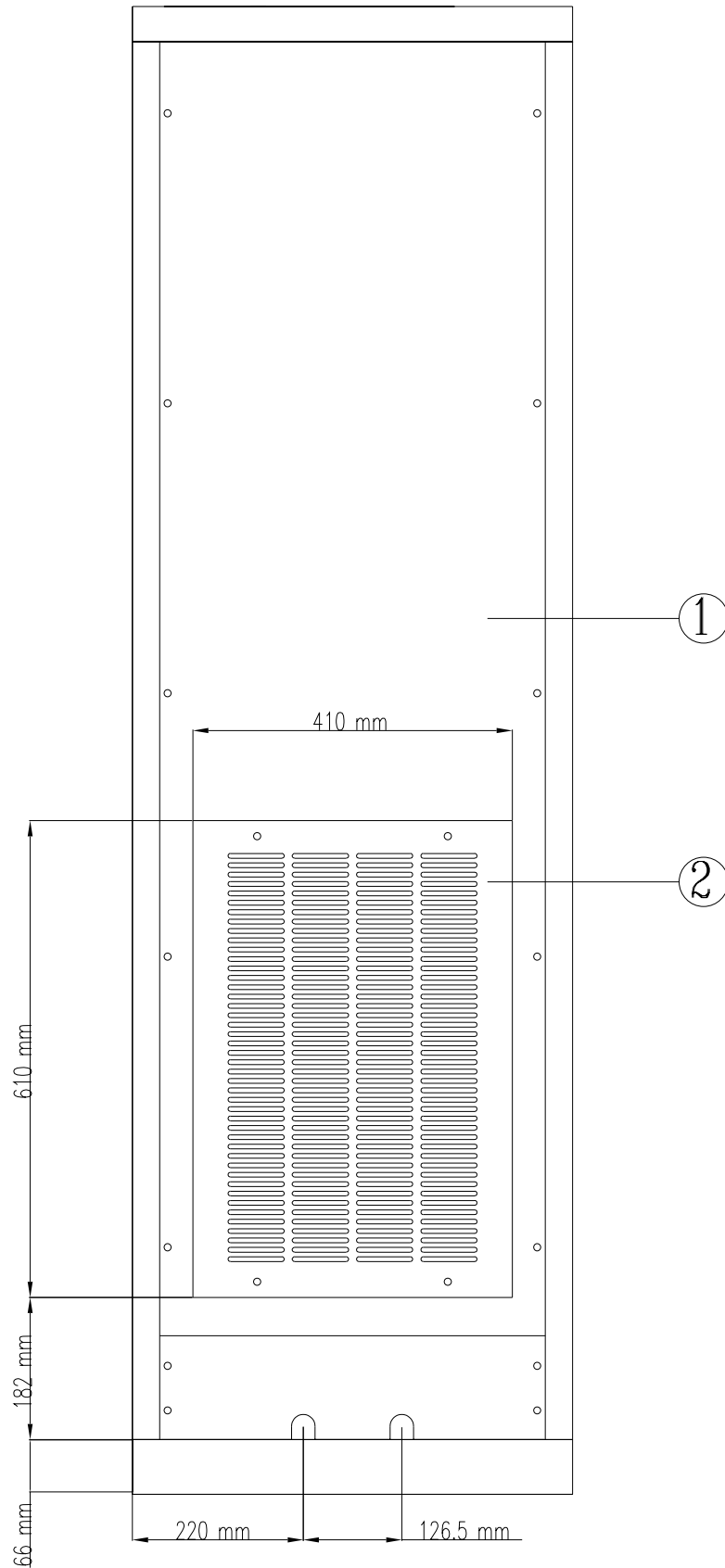

REF.

DESCRIPTION

- 1)
- 2)

Rear panel
Air filter

FIG. 3 UPPER VIEW

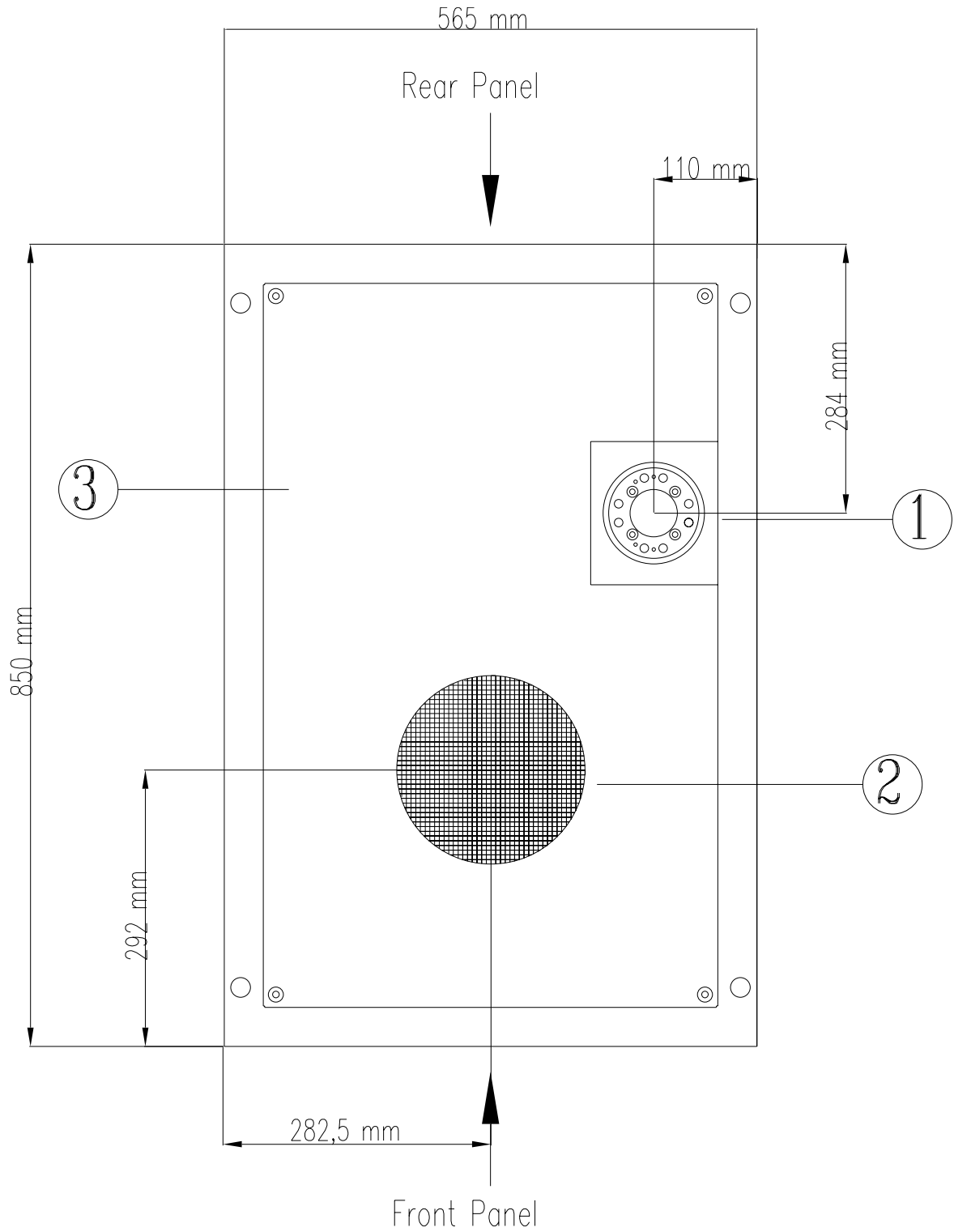

REF.

DESCRIPTION

- | | |
|------------------------------------------------------------------------------|------------------------------------------------------------------------------------------------------------------------------------------|
| <ul style="list-style-type: none"> 1) 2) 3) | <ul style="list-style-type: none"> RF output connector (1+5/8") Output air chimney (200 mm) Upper panel |
|------------------------------------------------------------------------------|------------------------------------------------------------------------------------------------------------------------------------------|

FIG. 4 HINGED FRONTAL PANEL WITH TELEMETRY

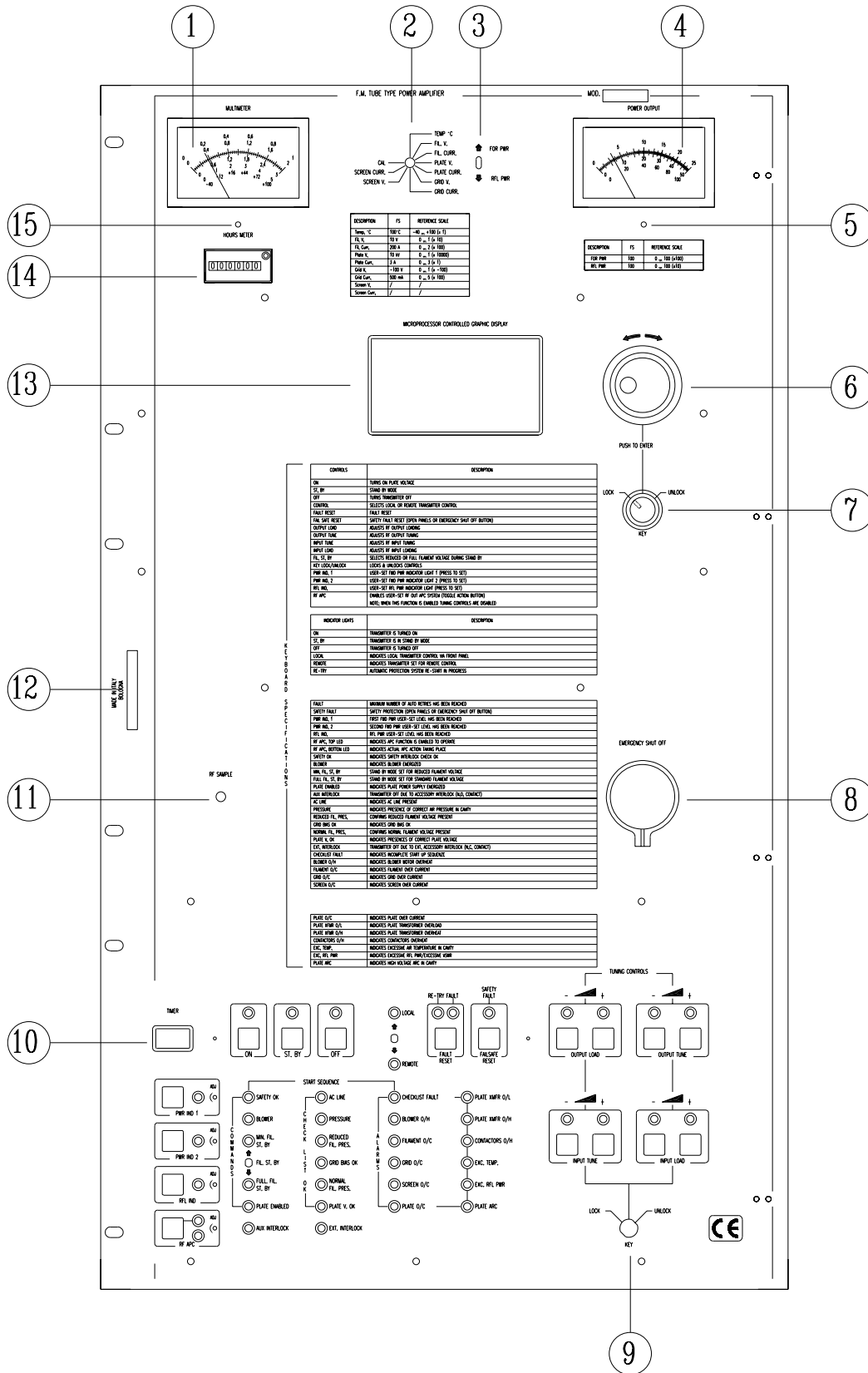

<i>REF.</i>	<i>DESCRIPTION</i>
1) MULTIMETER:	Analog instrument for the measures of temperature, filament voltage and current, anode voltage and current and grid voltage.
2) VOLTAGES SELECTOR:	Voltages selector for the measures of the following.
3) FWD/REF SELECTOR:	Selector for forward / reflected power measure.
4) POWER INSTRUMENT:	Analog instrument for the measure of the forward and reflected power
5) INSTRUMENT RESET:	Mechanical reset of analog instrument for the measure of the forward and reflected power.
6) ENCODER:	Encoder for telemetry connection (optional).
7) ENCODER SWITCH:	Key switch to enable the telemetry (optional).
8) EMERGENCY PUSH SWITCH:	Emergency push switch to stop the equipment.
9) TUNING KEY SWITCH:	Key switch to enable the motorized tuning.
10) TIME FILAMENT DISPLAY:	Display for the screening of the pre-heating filament time.
11) R.F. SAMPLE:	Connector for R.F. signal test.
12) HANDLE:	Handle to open the hinged panel
13) DISPLAY:	Display for the screening of the equipment and telemetry parameters (optional).
14) HOURS COUNTER:	Equipment working hours counter
15) VOLTAGES RESET:	Mechanical reset of analog instrument.

FIG. 5 HINGED FRONTAL PANEL WITHOUT TELEMETRY

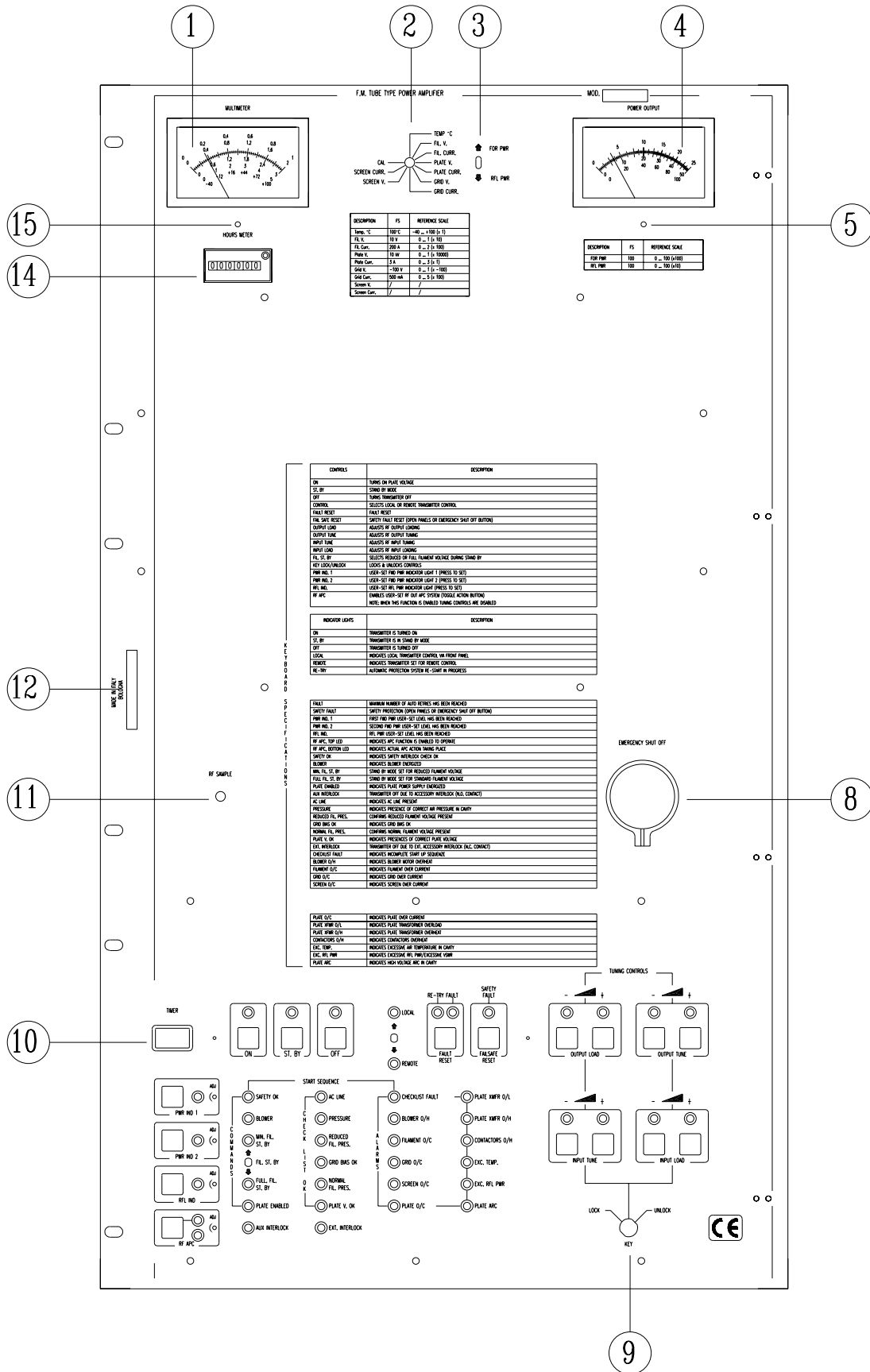
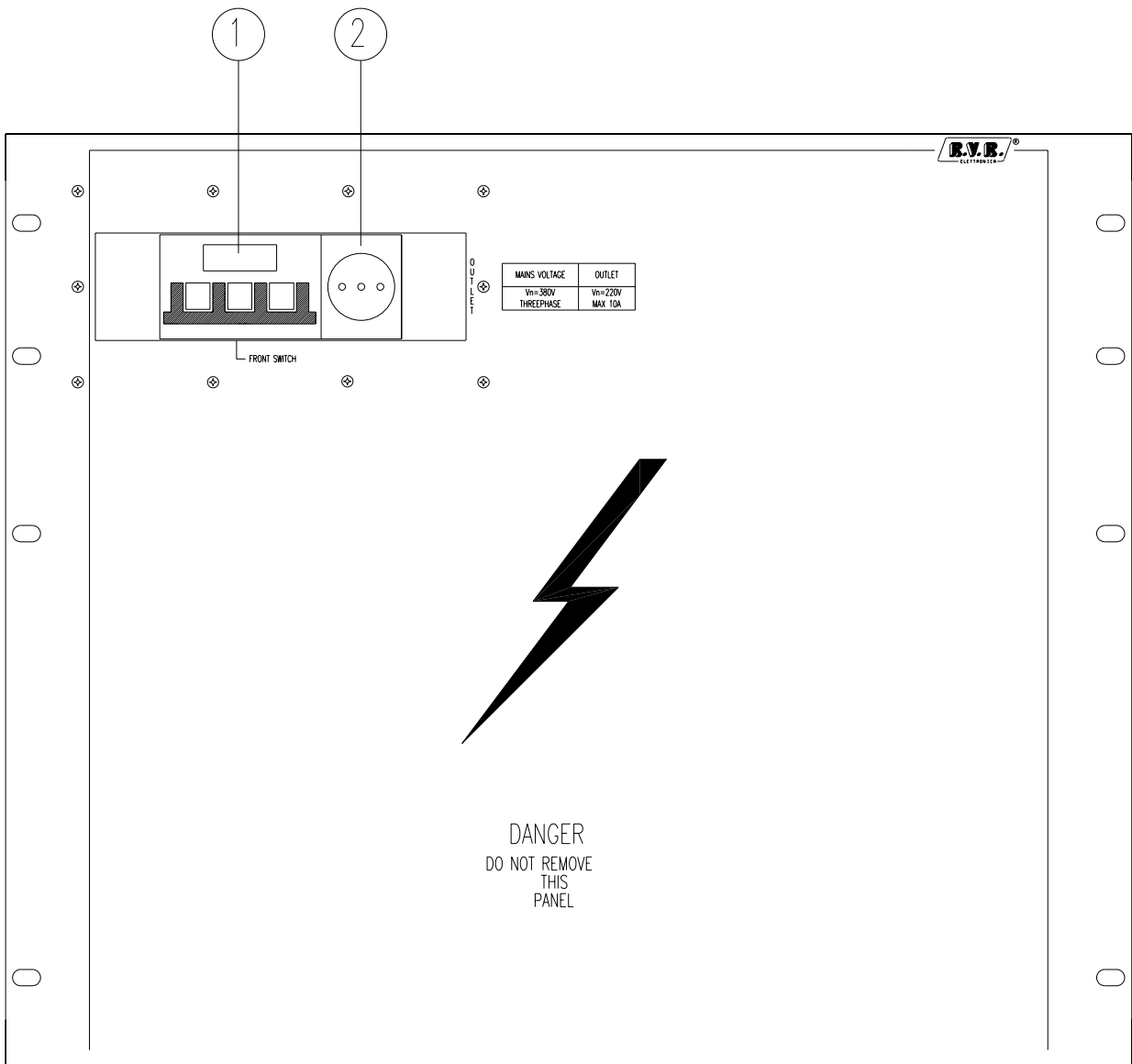

FIG. 6 HIGH VOLTAGE PANEL



REF.

DESCRIPTION

- 1) Quadripole main switch
- 2) Service outlet.

FIG. 7 P1 POWER SUPPLY SECTION VIEW

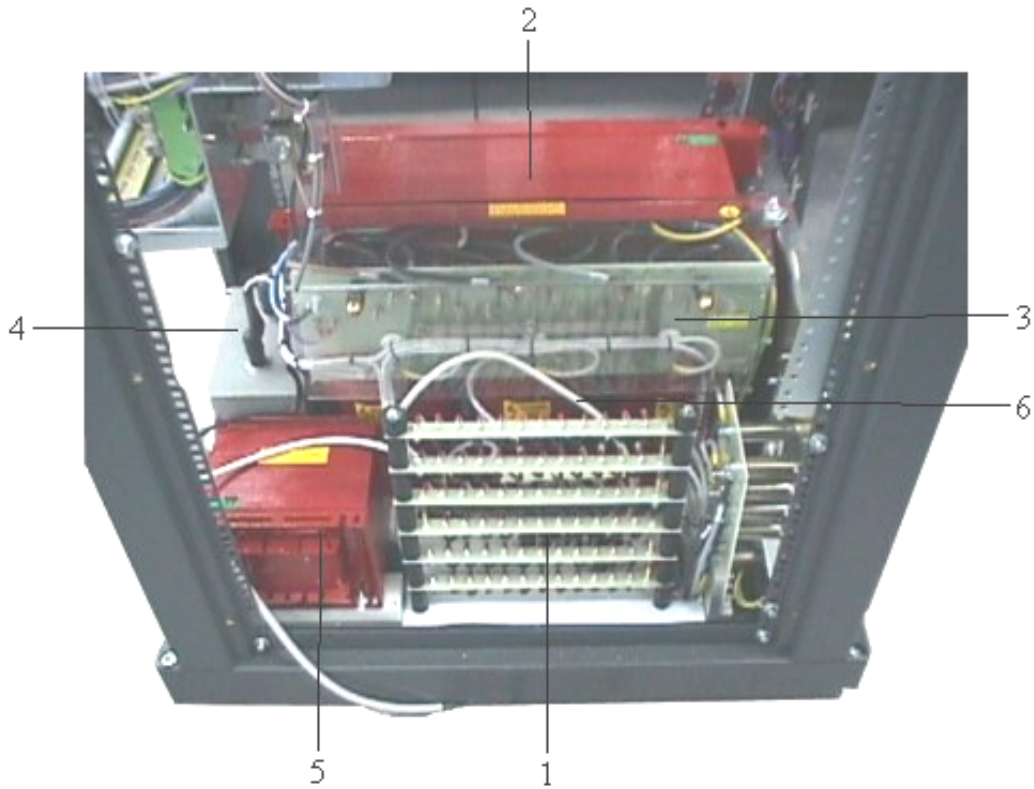

REF.

- 1)
- 2)
- 3)
- 4)
- 5)
- 6)

DESCRIPTION

- Rectifier diodes bridge for plate voltage.
 Plate voltage power supply transformer.
 Plate Voltage transformer socket.
 Plate voltage filtering capacitor.
 Inductance.
 Discharge resistor for high voltage capacitor.

FIG. 8 P2 POWER SUPPLY SECTION VIEW

<i>REF.</i>	<i>DESCRIPTION</i>
1)	Tuning relays card.
2)	Power relays card.
3)	Filament solenoid switch 1.
4)	Filament solenoid switch 2.
5)	Blower solenoid switch.
6)	High tension solenoid switch 1.
7)	High tension solenoid switch 2.
8)	Three phase input socket (mono phase on request).
9)	Services transformer.
10)	Electromechanism telemetry card (optional).
11)	Filament transformer.
12)	Blower overload cutout.
13)	Three phase checking presence.
14)	Blower and filament stabilizer power socket (optional).
15)	Fuses service socket.
16)	I/O for external interlock.
17)	Tuning motor input (LOAD).
18)	Driver power supply.
19)	Tuning motor grid (TUNE).
20)	Pressure switch.
21)	RF cavity input.
22)	Driver solenoid power supply.
23)	Power supply selection.
24)	Insulator transformer for filament readings.

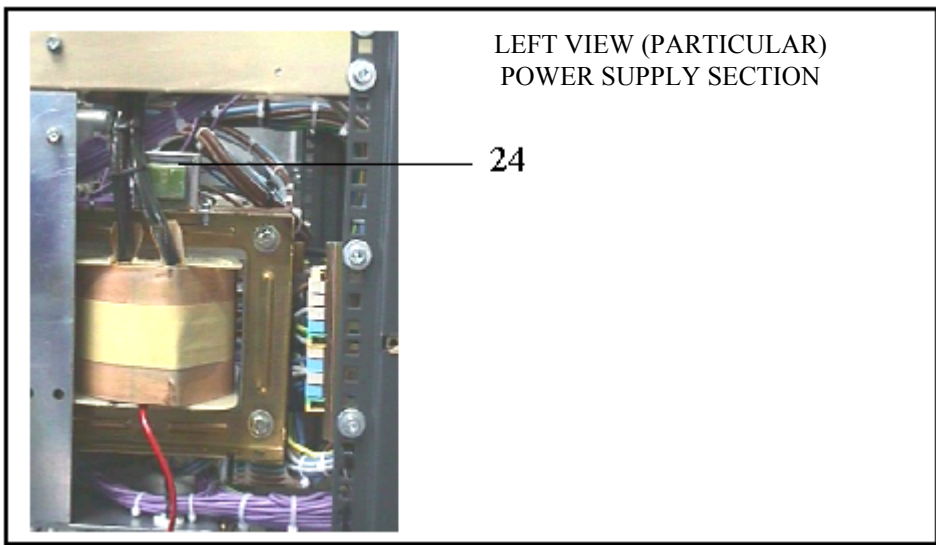
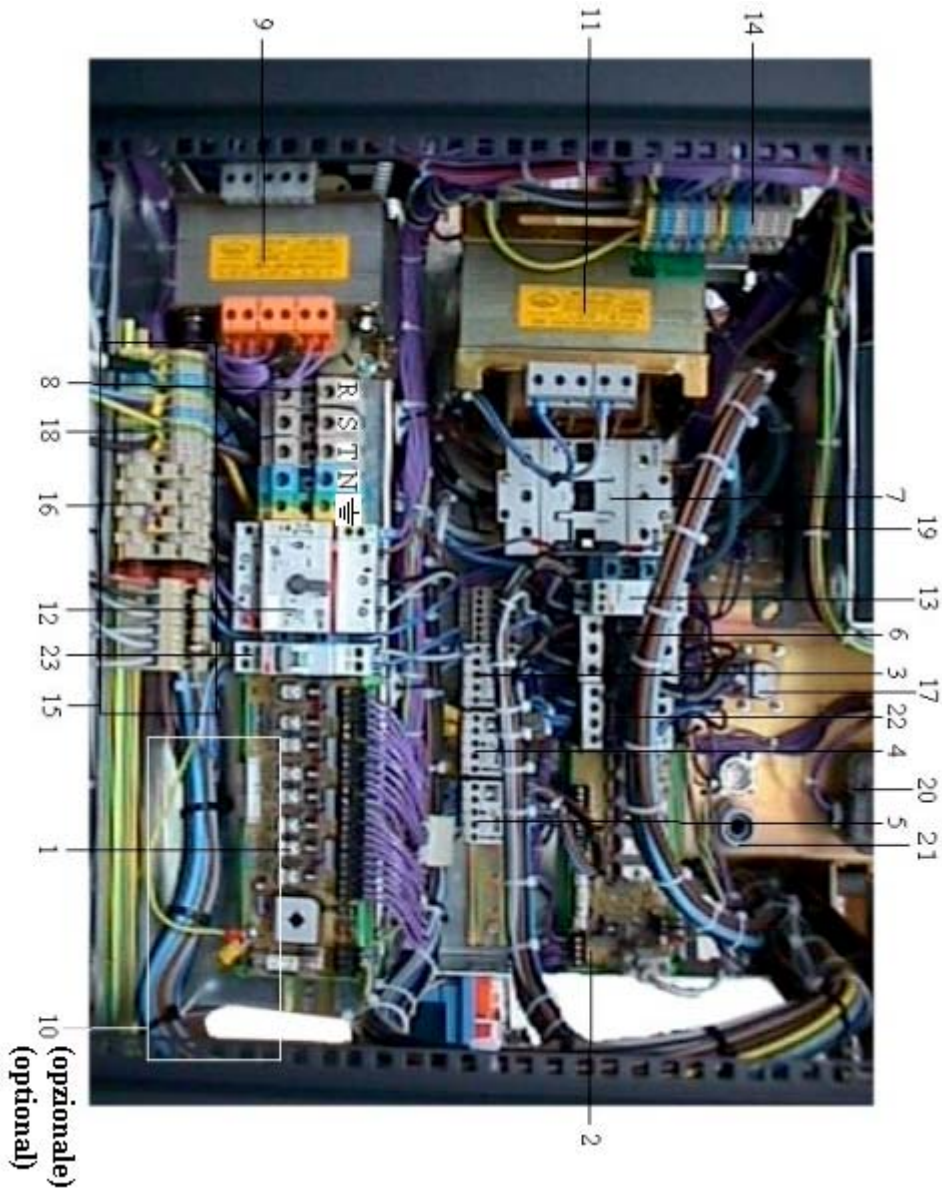

FIG. 9 R.F. CAVITY FRONTAL VIEW



REF.

DESCRIPTION

- | | |
|----|------------------------------------|
| 1) | Threaded bar for motorized tuning. |
| 2) | Sliding plane with fingers. |
| 3) | Plate pipe. |
| 4) | Wrapper. |
| 5) | Plate ring. |
| 6) | Wrapper. |
| 7) | Blower air input. |
| 8) | Load capacitor. |

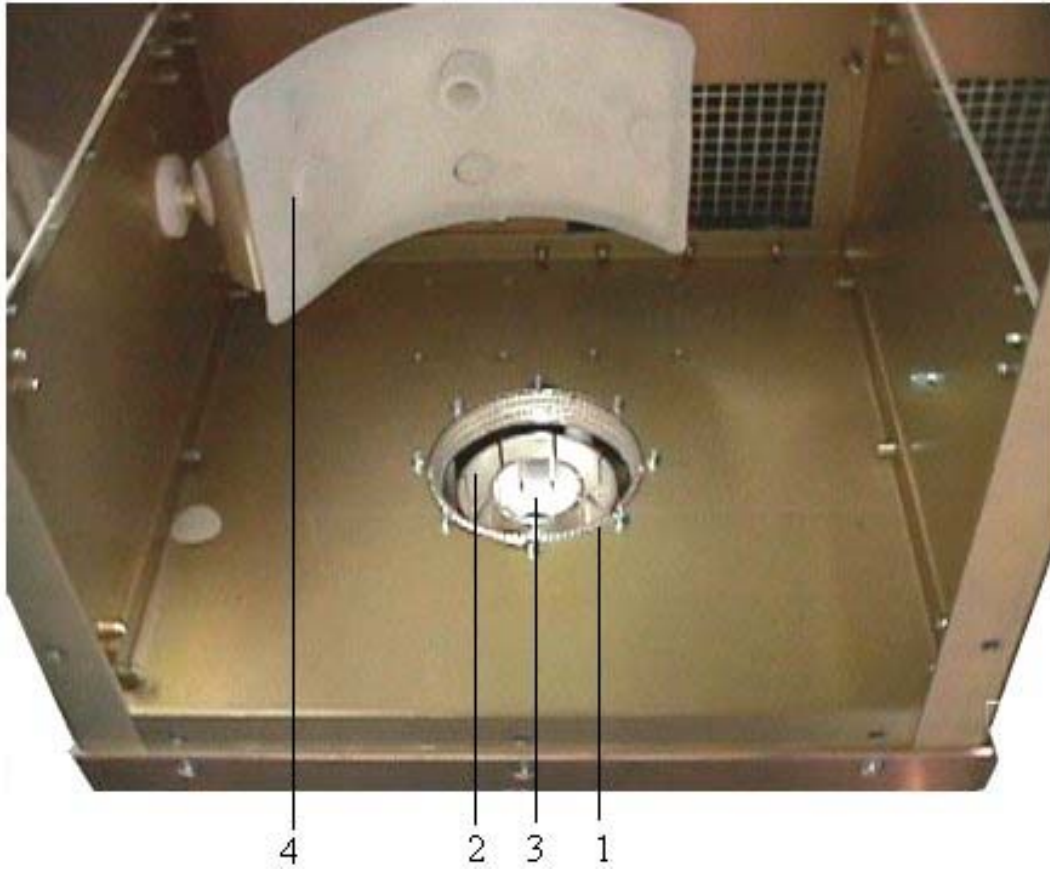
FIG. 10 R.F. CAVITY FRONTAL VIEW***REF.***

- 1)
- 2)
- 3)
- 4)

DESCRIPTION

- Plate ring.
Tube Socket filament contact.
Tube Socket filament contact.
Load capacitor.

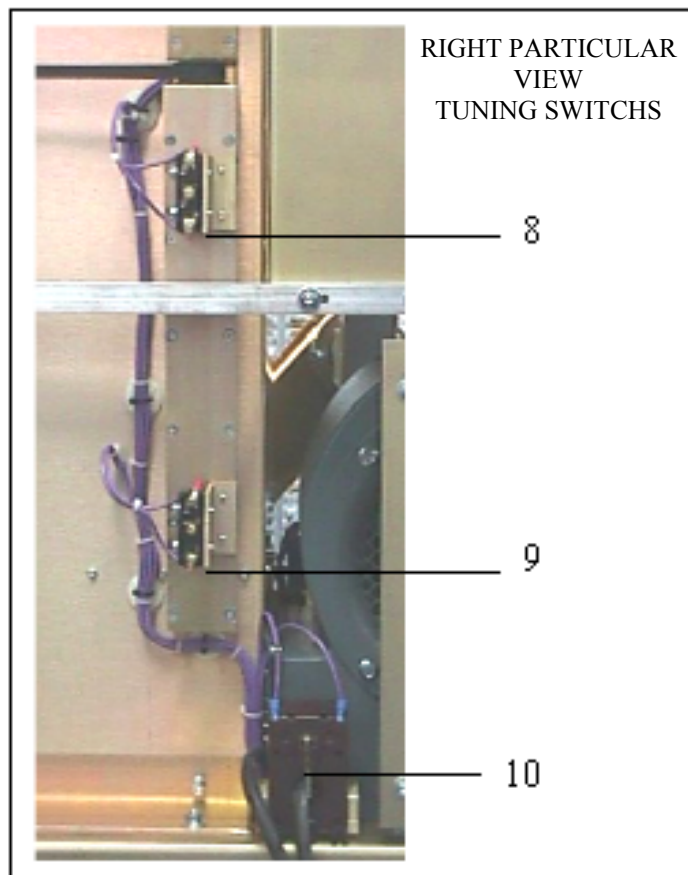
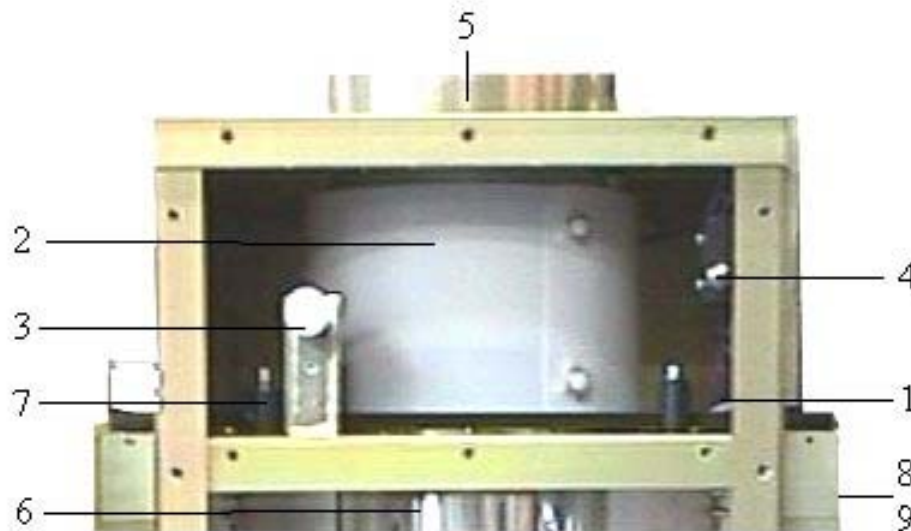
FIG. 11 TUNING MOTORIZED MECHANISM VIEW**RIF.****DESCRIZIONE**

- | | |
|----|-----------------------------------------------------------|
| 1) | H.T. cable. |
| 2) | Plate pipe isolator. |
| 3) | Horn gap arrester. |
| 4) | Micro switch for R.F. cavity protection. |
| 5) | Plate pipe. |
| 6) | Moving strap plane. |
| 7) | Micro switch for top end position of the sliding plane. |
| 8) | Micro switch for upper end position of the sliding plane. |

9)

T.A.

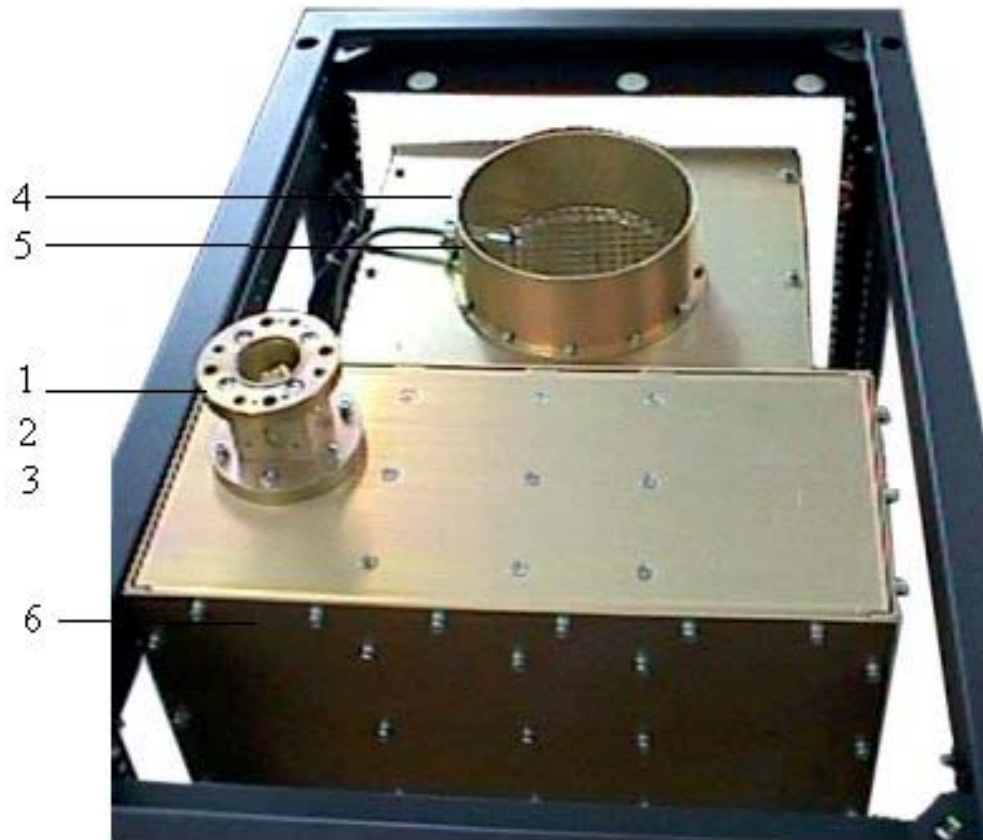
FIG. 12**R.F. CAVITY TOP VIEW*****RIF.***

- 1)
- 2)
- 3)
- 4)
- 5)
- 6)

DESCRIZIONE

- EIA 1+5/8" flange (R.F. output connector).
Wattmeter.
Directional coupler.
Output air chimney (diameter 180 mm).
Temperature strobe.
Low-pass filter.

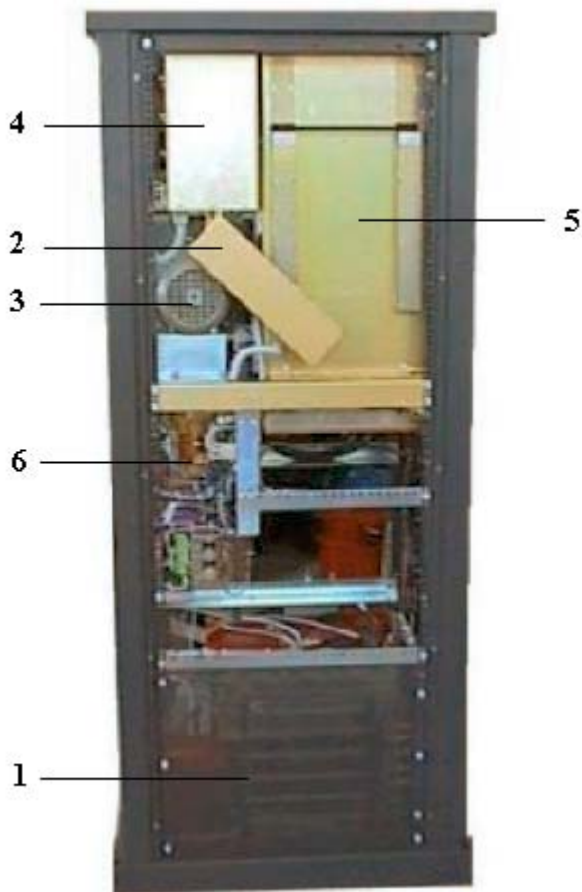
FIG. 13**R.F. CAVITY LEFT LATERAL VIEW**

VIEW DISSASSEMBLED STRIPLINE

RIF.

- 1)
- 2)
- 3)
- 4)
- 5)
- 6)

DESCRIZIONE

- Power supply plane.
 Stripline.
 Blower
 Low pass filter .
 Cavity RF.
 Electro mechanical plane.

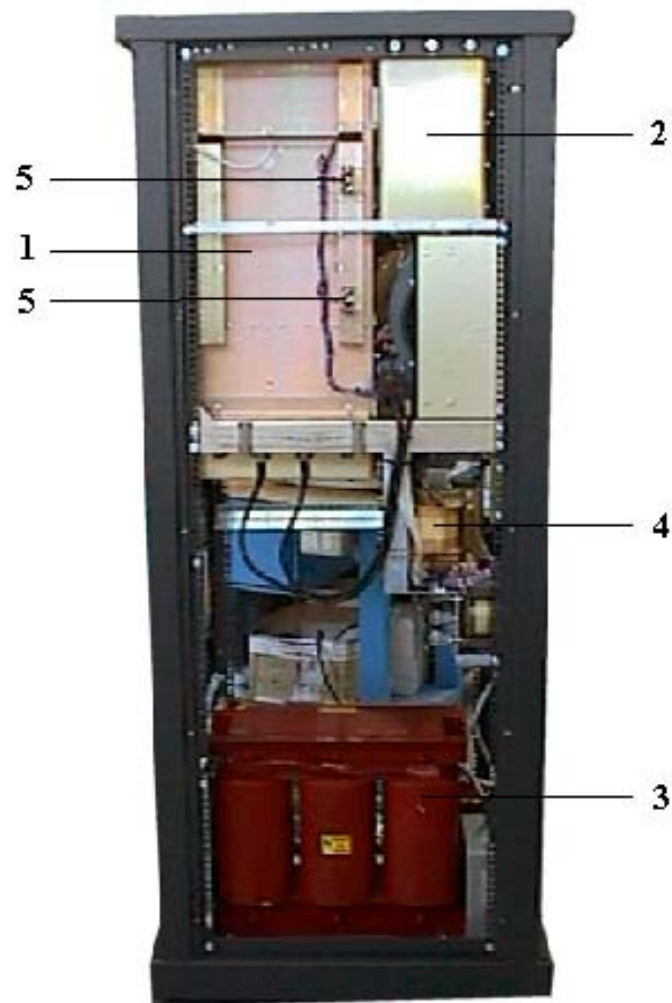
FIG. 14 R.F. CAVITY RIGHT LATERAL VIEW***RIF.***

- 1)
- 2)
- 3)
- 4)
- 5)

DESCRIZIONE

- Cavity Rf view.
Low pass filter view.
Power supply section
Electro mechanical plane.
Power switches for tuning motors.

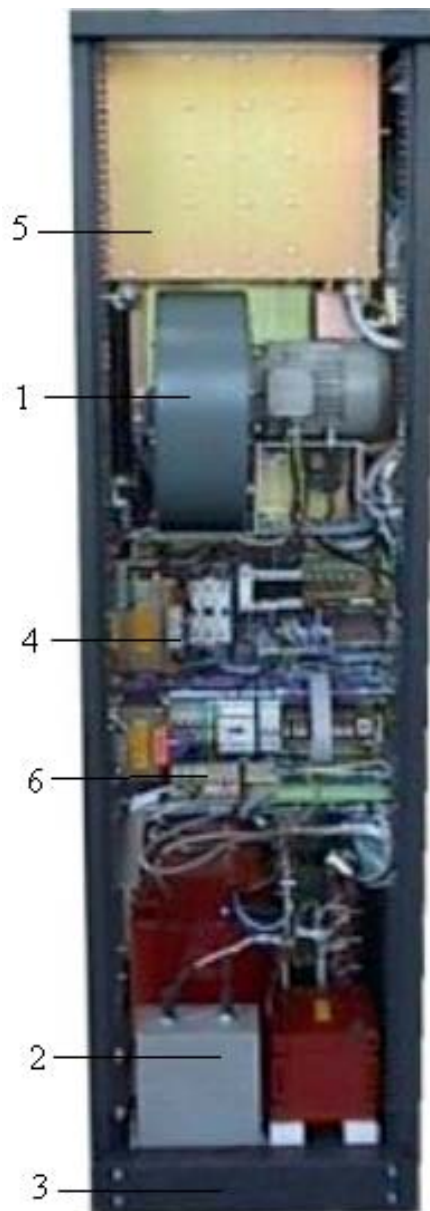
FIG. 15 REAR VIEW***RIF.******DESCRIZIONE***

- | | |
|----|----------------------------|
| 1) | Blower. |
| 2) | Power supply plane. |
| 3) | Power transformer support. |
| 4) | Electro mechanical plane. |
| 5) | Low pass filter. |
| 6) | Service calmps. |

CHAPTER 3

EQUIPMENT INSTALLATION

3.1 INTRODUCTION

This chapter contains the necessary information for the installation and the preliminary checks of the VJ10000-TR amplifier.

3.2 UNPACKING

Remove the equipment from its packing, Verify that the unit that isn't damaged during the transport. Controls all parts on the front panel are operative.

First: remove the transformer from the packing.

Second: remove the lateral ant frontal pannel.

The necessary equipment are: a screwdriver with cross head , a soket wrench 7 mm and 10 mm, a setscrew wrench M6, M8.

Make sure to have a container where put all the screws. Remount all screws and to make sure that isn't component outside the appropriate position.

Then insert the power transformer support into rack, to make sure to have removed the screws with the setscrew wernch M6. Now remove the plexiglass protection and connect the appropriate contacts, use for this operation setscrew wrench M8, and a setscrew pipe M6.

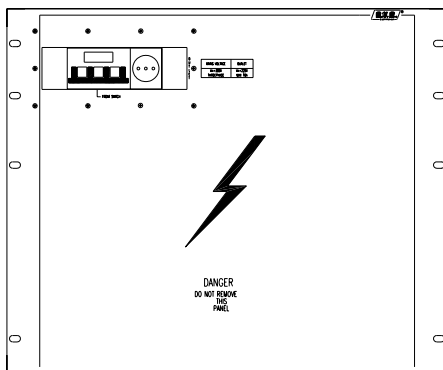

MAIN PANNEL

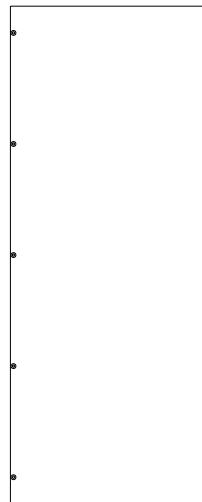

LATERALE PANNEL

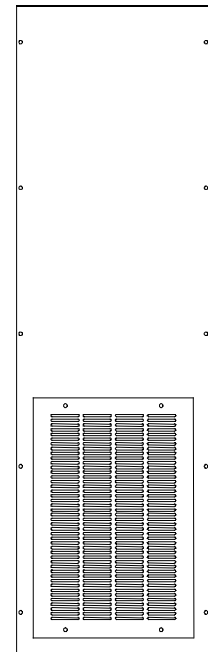

REAR PANNEL

After, insert the cart of the transformer interior shot the back rack, make sure to have removed first the four screws M6 with the key to setscrew wrench M6.

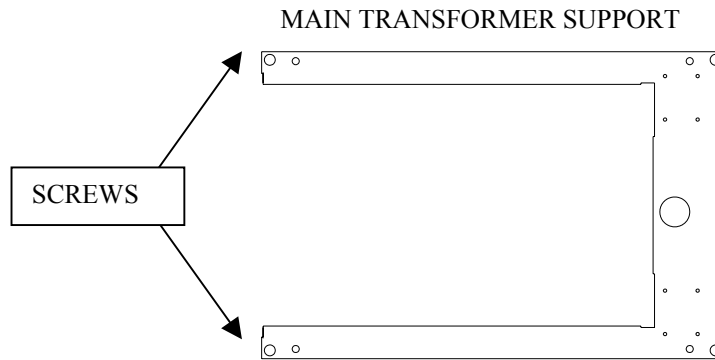

Once inserted the cart to the inside, to pass on the anterior part and to get off the plexiglass of protection and to lace the threads to the terminal board protection and to lace the threads of the terminal board (see drawings) with:

- n° 1 key socket wrench M8
- n° 1 setscrew wrench M6
- n° 1 screwdriver

POWER SUPPLY SOCKET

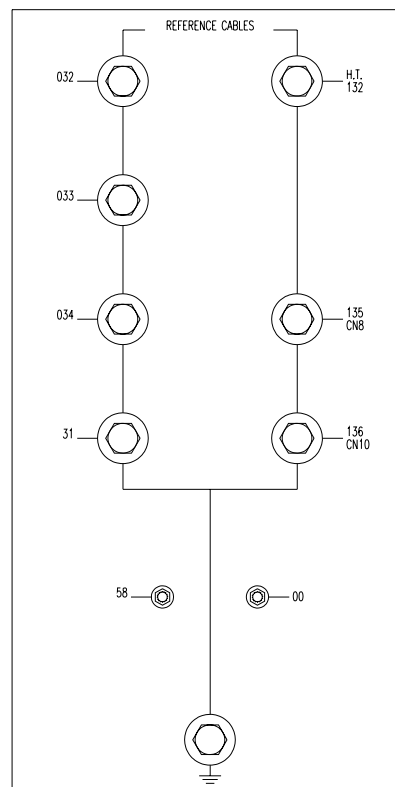

When the connections are connected, reassemble the plexiglas protection and the anterior 9 unities panel, close again the other panels, and proceed with the valve installation. Is advisable close the back panel only before working.

3.3 TUBE INSTALLATION

For the tube installation is necessary to execute the following procedure:

- 1) Connect the power supply cable in the relative socket paying attention to exact position of the phases and neutral. The mains voltage must be the same for that is been set the equipment (see as reference the test control card). Verify that the ground is very good. Connect a dummy load with adequate power, or the antenna, to the amplifier's output.
- 2) Open the hinged frontal panel placed on the R.F. section, unscrewing the screws "A" (FIG. 16) and then remove the frontal panel of the cavity.
- 3) Switch on the equipment through automatic interrupter and/or trough selector pressed OFF.
- 4) Now, enable the tuning push switches through the key selector and then push OUPUT TUNE to lift up the plane with fingers until the top position. If the button RF APC is turned on the tune motors don't works. Then, switch off again the equipment.
- 5) Loosen the clamp that fixes the plate ring and move it to the top limit (FIG. 17). Then, insert the tube and at the same time turn it until the grid ring is perfectly on the fixed socket ring of the cavity. To be sure of the correct insertion of the tube is necessary that the GRID 1 contact, that is the nearest to the plate, is totally inserted into the fingers mounted on the socket plane.

NOTE: Don't touch the tube ceramic with hands to avoid to leave traces of greasy; in case, wash the part with trichlorethylene or acetone.

- 6) Once the tube is been inserted, fix the high tension block on the top part of the tube (FIG. 19). It's very important to close this block correctly (using a setscrew wrench M5), so that the tube doesn't go out..
- 7) Then, decrease the plate ring until is perfectly connected to the tube as indicated in the Fig. 19, and then fix it with the apposite clamps both on the tube and on the plate ring.
- 8) Restart the amplifier, pressing OFF botton and contemporany OUPUT TUNE, to adjust frequency before working (see related pages above this chapter).
- 9) When you have checked that all these operations are been executed correctly, close the front panel. To make sure to not have left inside: utensils or bolts.

FIG. 16 TUBE INSTALLATION DIAGRAM N°1

SCREWS

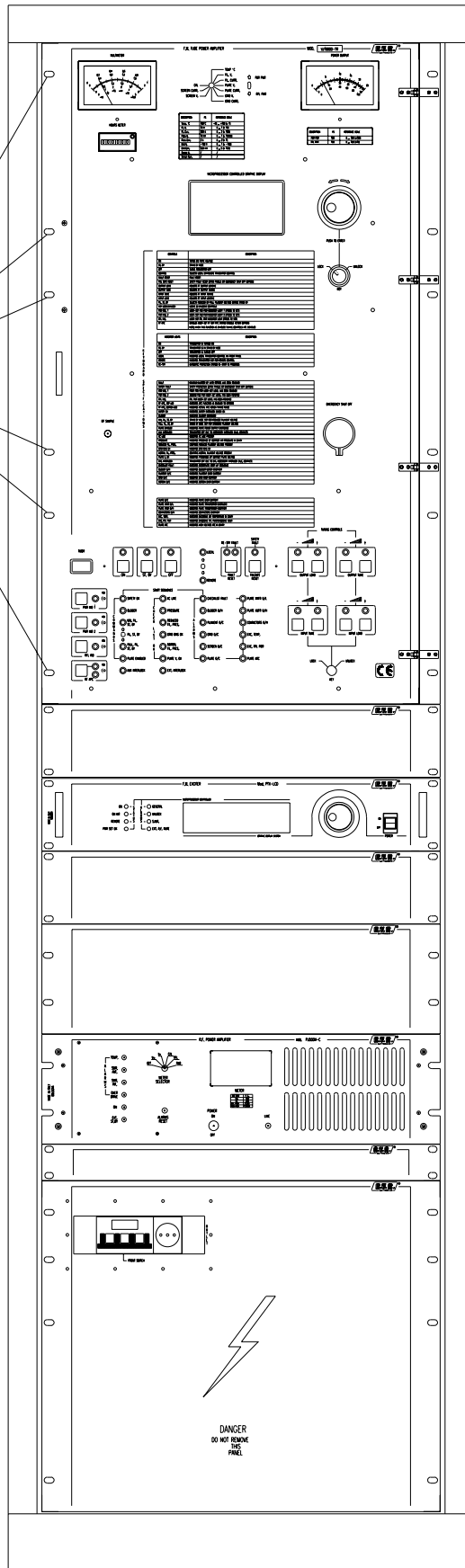

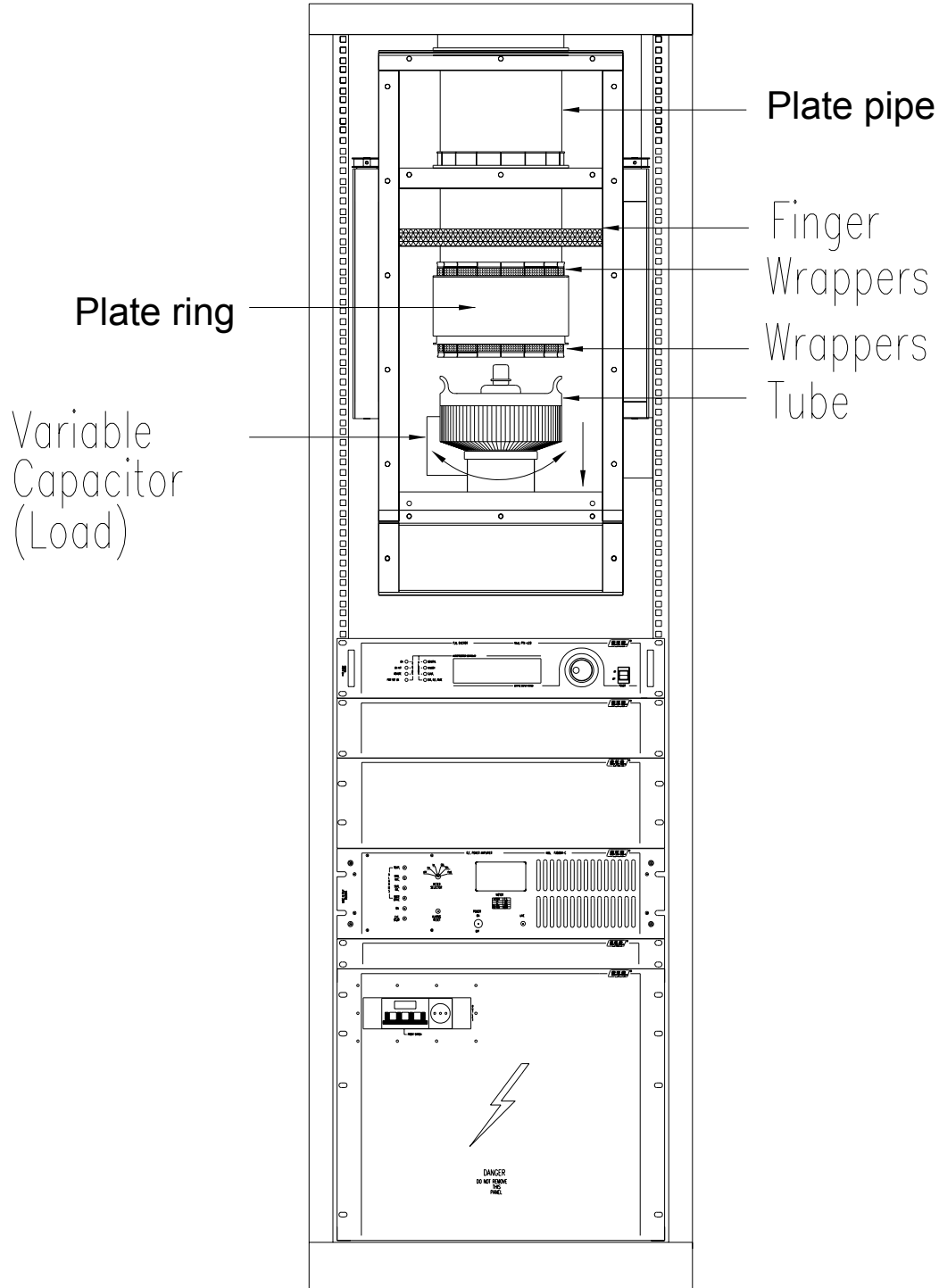

FIG. 17

TUBE INSTALLATION DIAGRAM N°2

FIG. 18

TUBE INSTALLATION REFERENCE VIEW N°2



FIG. 19 TUBE INSTALLATION DIAGRAM N°3

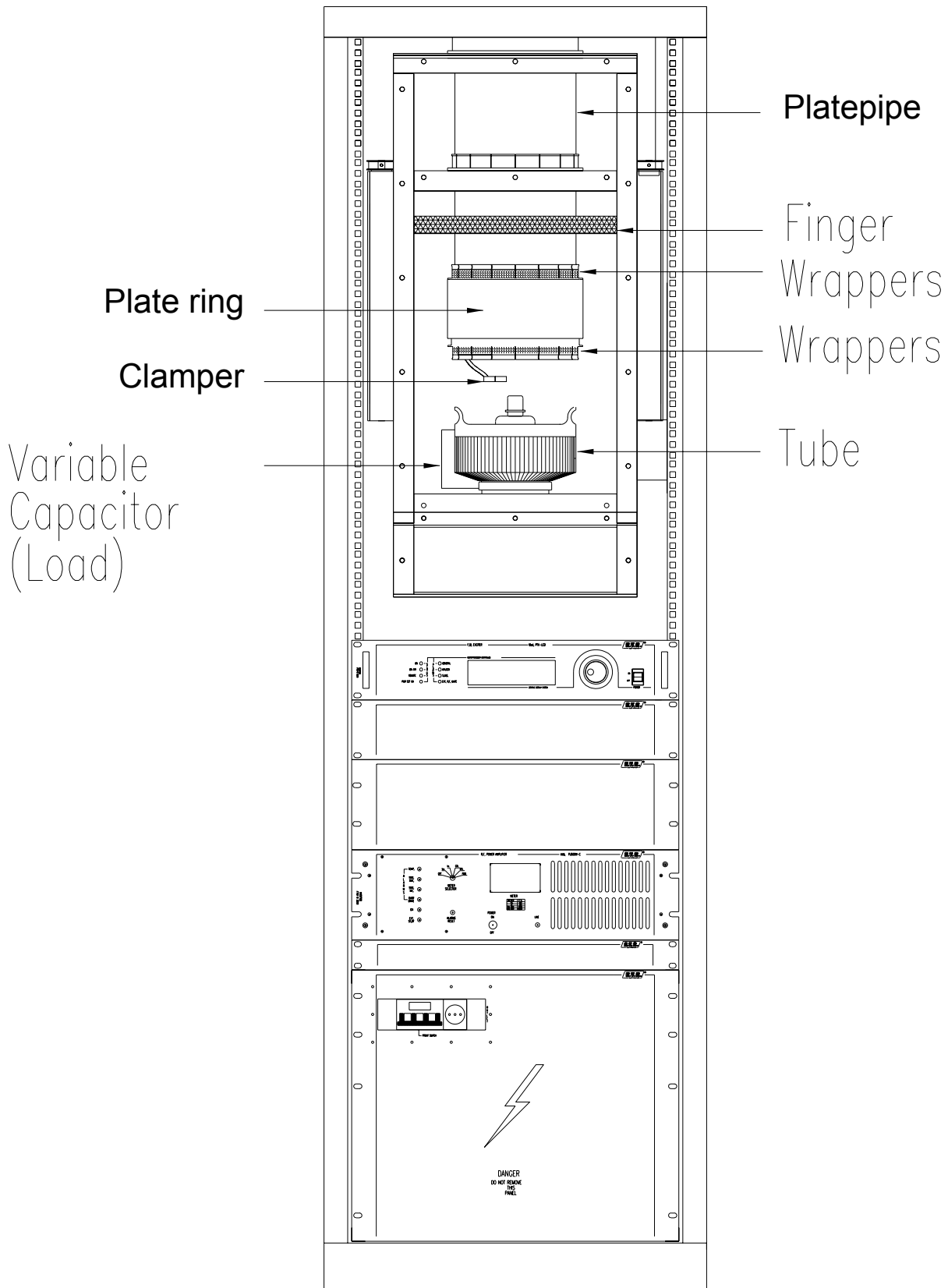

FIG. 20

TUBE INSTALLATION REFERENCE VIEW N°3



**PARTICOLARE
MORSETTO**

FIG. 21 TUBE INSTALLATION REFERENCE VIEW N°4

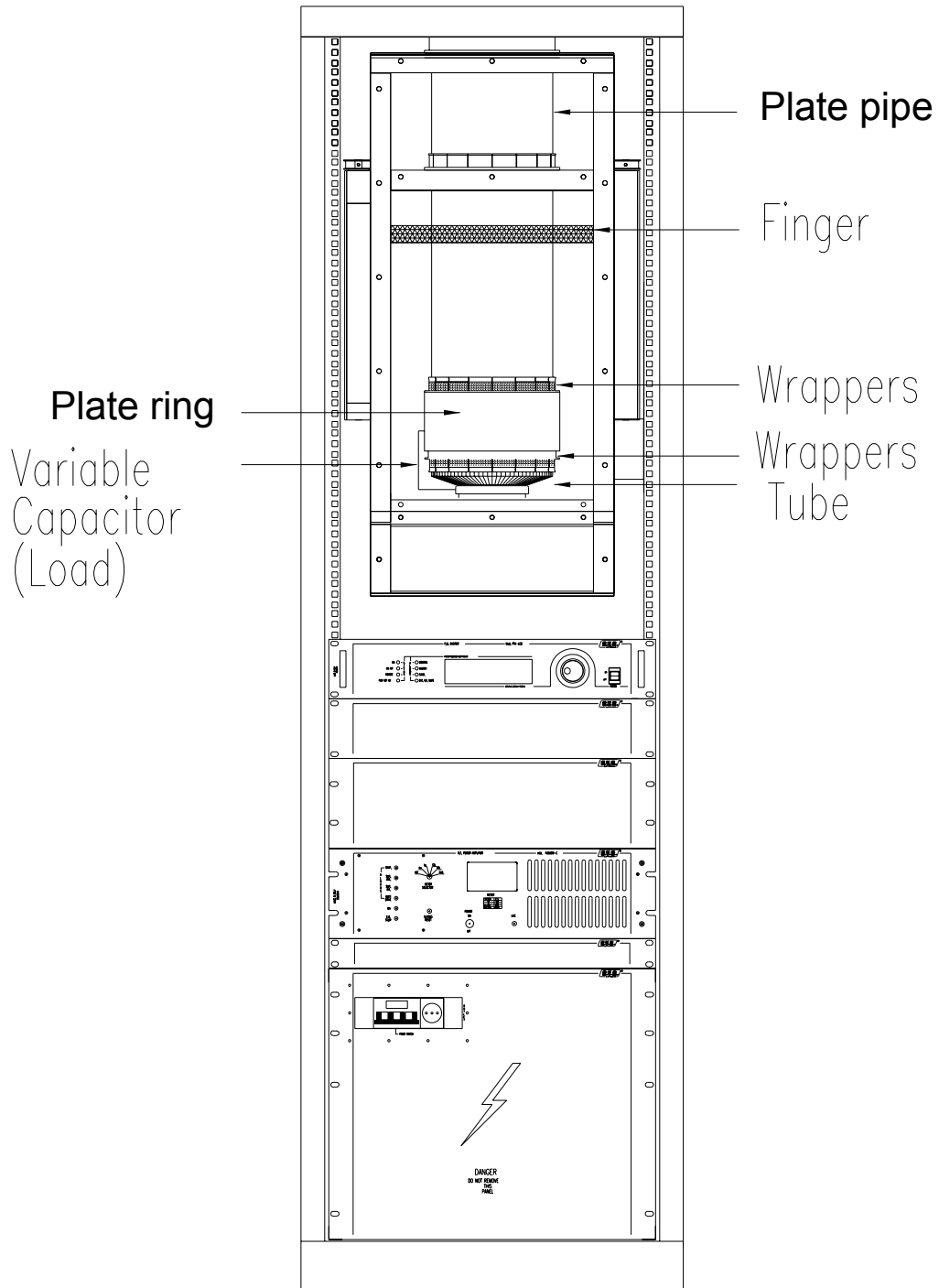

FIG. 22 **TUBE INSTALLATION REFERENCE VIEW N°4**



See for reference distance above tuning adjusting. (the distance correspondly to MHz)

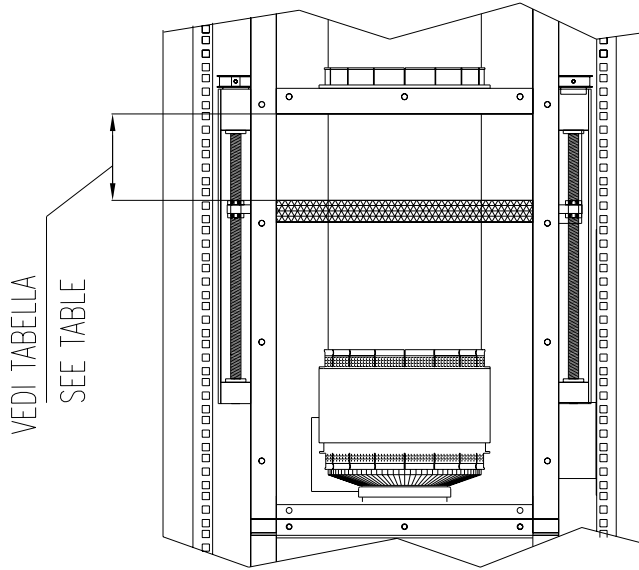

FIG. 23 REGULATION RF - MHZ

Height Cm	Frequence (Mhz)
9.5	88
10.5	89
11.5	90
12.5	91
13.5	92
14.5	93
15.5	94
16.5	95
17.5	96
18.5	97
19.5	98
20.5	99
21.5	100
22.5	101
23.5	102
24.5	103
25.5	104
26.5	105
27.5	106
28.5	107
29.5	108

TABLE C - FREQUENCIES REFERENCE

3.4 EQUIPMENT SETTING AT WORK

To set at work the amplifier VJ10000 it's necessary to execute the following operations:

- 1) The equipment is set for a mains voltage of 380 Vac (other on request), three phases with neutral. It's very important connect the neutral on the terminal marked N (blue), while for the versus of the phases it's necessary to respect the sequence R, S, T so that the MAINS led is on, and since the blower is three phases type in any case to be sure the right rotation version of the blower. For the connection of the exciter and driver use the apposite auxiliary terminals (FIG. 8); to be sure to connect them to the relative terminals to avoid tube and amplifier irreparable damages. After the tube mounting as showed in the previous paragraph, connect again the mains voltage. All the panels owe being closed, or the tube amplifiers doesn't start (safety condiction).
- 2) Set the exciter at the minimum power and place the ST: BY/H.V. ON on the ST. BY position.
- 3) Place the driver ON/OFF switch to OFF position. Switch on the equipment through the main switch and wait for the heating time. The number on the display shows the relative heating time. This time can be set between four values by internal jumpers on the protection card as described in the protection logic specifications.

NOTE: Pay attention to don't broke the Interlock micro switches that stop the equipment.

- 4) Check with the multimeter that filament current is about 160 A.
- 5) Now, using the panel multimeter, verify that the filament voltage is $6.3V \pm 0.37 V$; if the correct sequence is follow starting the Timer for pre-heating previous to chenge in anodic voltage.

If it doesn't work, follow the instructions to pag. 42 to verify the absence of signals on the measures card.

Ended to count of the Timer, the button is put in ON and must depart the electromagnetic switch HT1 and HT2 if the electromagnetic switch departing HT1 is not turn the led: there is a short circuit on the H.T.

Check to have installed the valve correctly.

Once starts the electromagnetic switchs HT1 and HT2 and the valve has been installed correctly must be present an anodic current of 350-400 MA (it depends on the valve) without pilotage. The valve has been installed correctly and that the amplifier is ready.

- 6) Switch on the exciter and when is lock to the set frequency, increase the power until 20-25 W.
- 7) Now, by the motorized tuning commands INPUT TUNE and INPUT LOAD moove the motors of tuning, verify to obtain the minimum SWR readable on the exciter PWR meter; at the same time, verify to obtain a plate current increasing.
- 8) Adjust the OUPUT TUNE command to obtain the maximum value of the output power and execute the same sequence to OUPUT LOAD command.

- 9) Increase the driving power and then execute a new adjustment through the OUPUT TUNE and OUPUT LOAD commands until you have the maximum exciter output power. Using only the modulator is possible to reach an output power of 600-700 W (with 3CX15000A7).
- 10) Decrease at minimum power the exciter and then connect in series the driver amplifier.
- 11) Switch on again the exciter, and repeat the tuning operations sequence of INPUT TUNE and INPUT LOAD for the least output power and consequently of OUPUT TUNE and OUPUT LOAD for the maximum output power, increasing gradually the input power; in case that increasing driving power increases the input SWR of the VJ10000, adjust the input tuning by INPUT LOAD and INPUT TUNE for the minimum SWR value.
- 12) Adjust now, the driving power level and OUPUT LOAD and OUPUT TUNE tuning to obtain a output power of 10 KW. For all other parameters see as reference the CHECK TEST TABLE enclosed to equipment, keeping in mind that the maximum value are the following::

IA = 2.5 A

VF = 6.3 VAC

ROS o RFL = 1000 W

Ig = 500 mA

If = 160 A

CHAPTER 4

TUBE MEASURES CARD CALIBRATION

4.1 NOTICE

Pay attention, this calibration is been executed initially on the final power amplifier during the checking test, only in case of card replacement, after that is been verified that is the cause of the equipment anomaly, is necessary to proceed to the calibration of the card as described later on. Before to proceed to the calibration, check on the card if J3 is in short circuit, and if it's verified, the card is been configured for a tetrode amplifier.

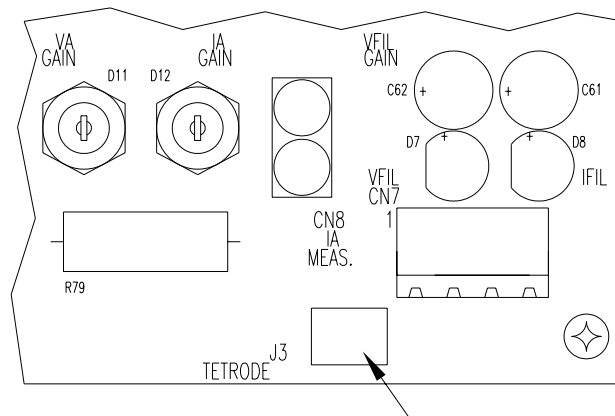

If the short-circuit is on J4 the card is been set for a triode amplifier.

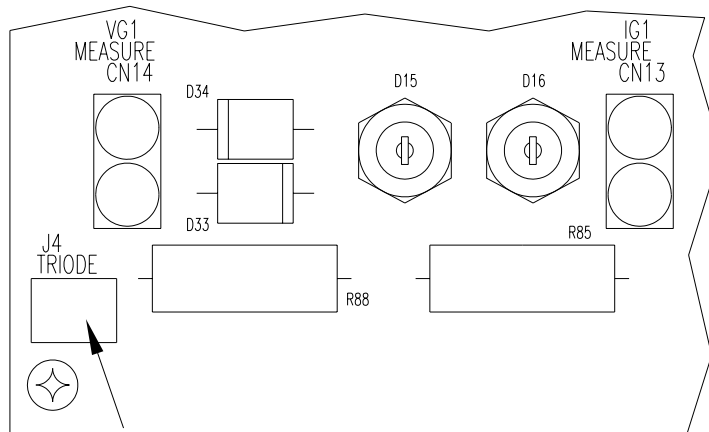

4.2 INTRODUCTION

To calibrate the measures card for tube amplifiers, placed near to mains voltage switch in the rear part of the high tension panel 9H (Fig.3), it's necessary to have:

- N_1 power supply 0-20V, 0-10 adjustable both in tension and in current.
- N_1 multimeter.
- N_1 DC ammeter.

FIG. 25 MEASURES CARD REPLACING DIAGRAM N°1

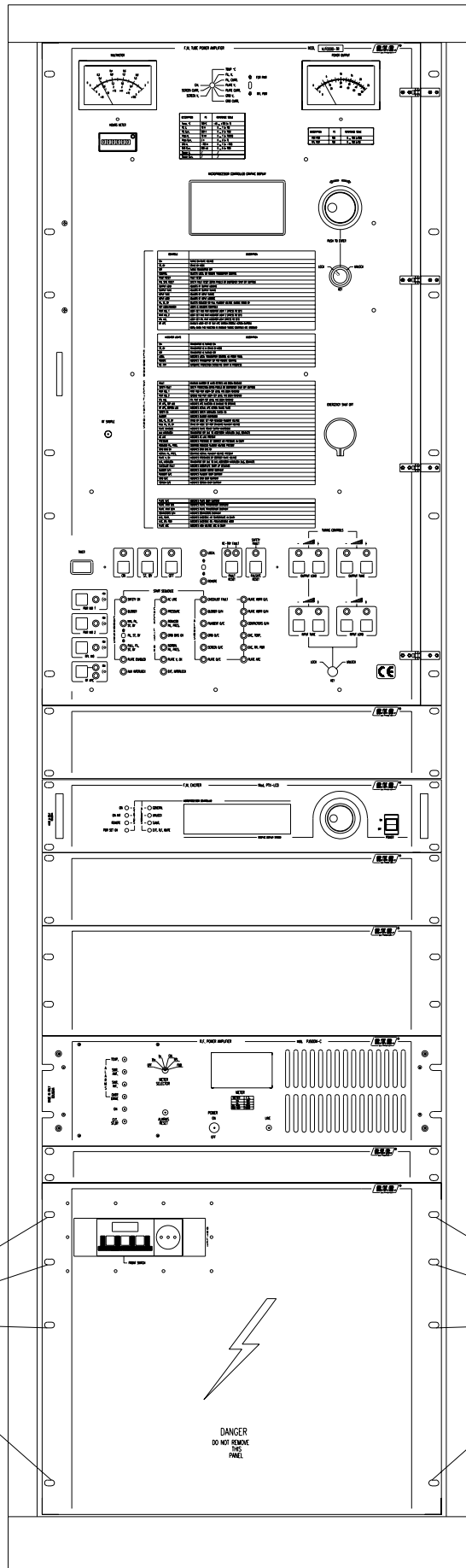

VITI SCREWS

VITI SCREWS



DANGER
DO NOT REMOVE
THIS
PANEL

FIG. 26

MEASURES CARD REPLACING DIAGRAM N°2

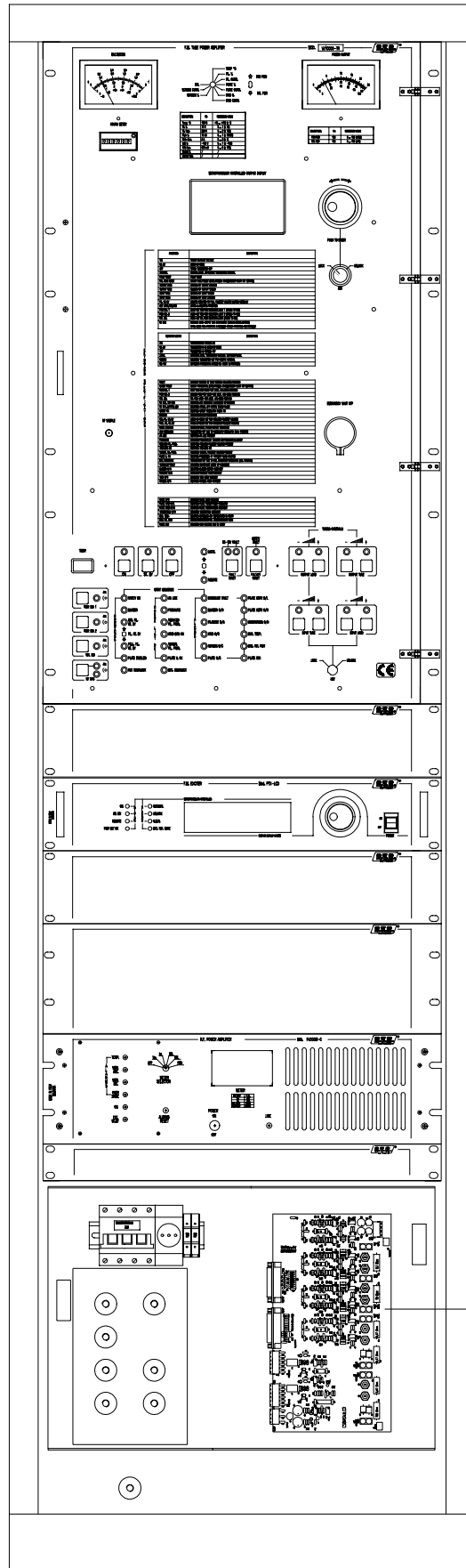

MEASURE CARD

Now, it's necessary calibrate the voltage value nearest to zero using the following trimmers:

- P1 for VF
- P2 for IF
- P3 for VA
- P4 for IA

- P5 for IG1
- P6 for VG1
- P7 for IG2
- P8 for VG2

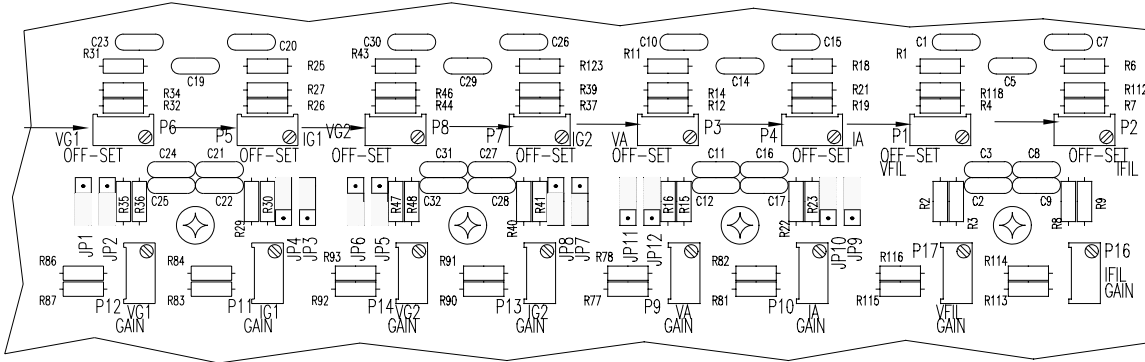

For reading the voltage values using always the multimeter with the negative connected to ground and the positive connected to relative test point in according to the value that you want calibrate.

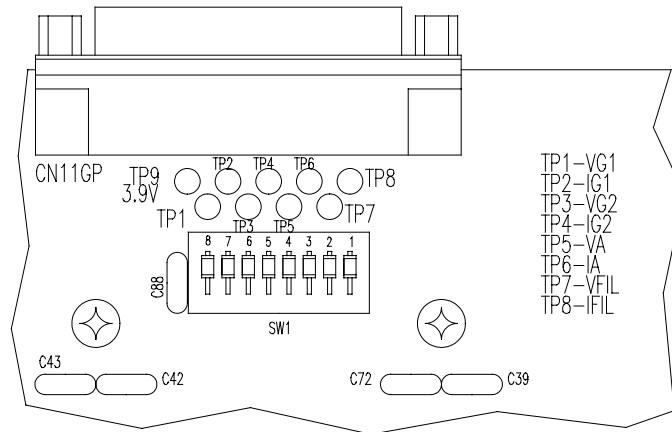

Because of the various tube type on which can be connected this card, can happen that the voltages measured, can be both positive and negative, but it's always necessary to have a positive voltage on the test point output. To obtain this, it is necessary to intervene moving some couple jumpers on the card on the ground of the negative value of the measure.

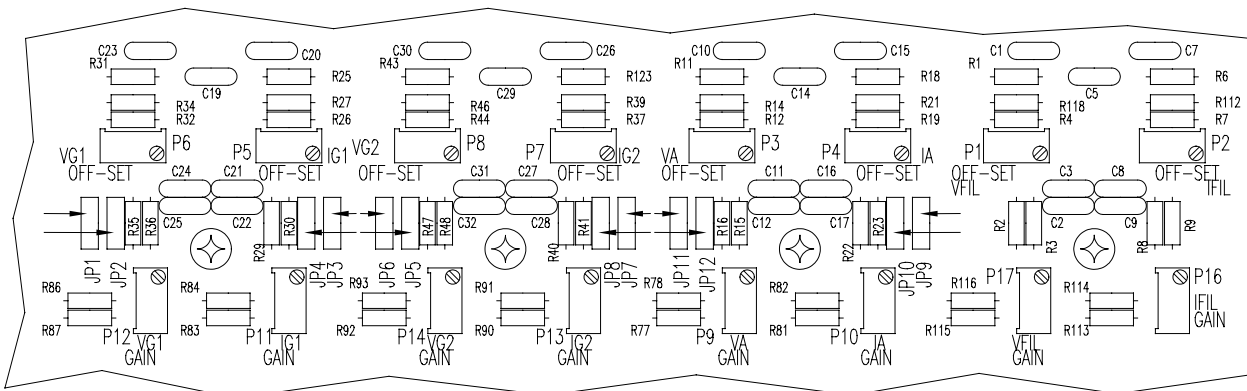

In this manual is furnished the jumpers position for the 3CX15000A7 tube installed on the VJ10000-TR

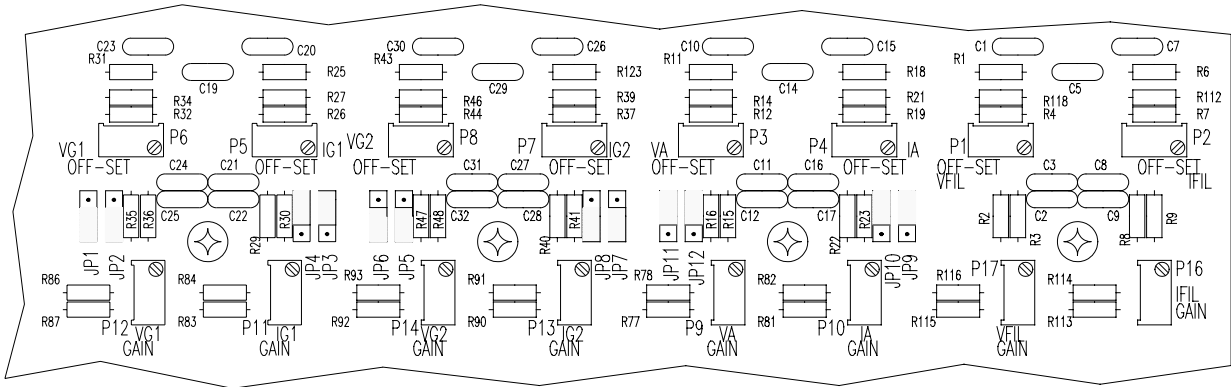

Once finished the previous operations it's necessary to connect a power supply with an ammeter in series (as shows in the following figure) to calibrate the IA and IG1 maximum current (IG2 not present in this equipment because triode version, present on the tetrode version). After the test point output voltages through the trimmers placed on the multimeter card, verify that the instrument, placed on the hinged front panel, read correctly.

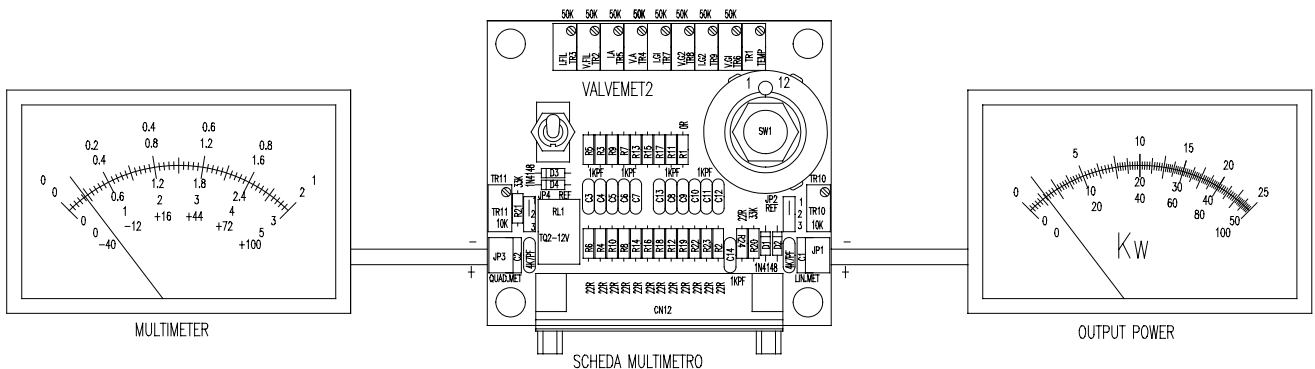

If the reading of the multimeter corresponds to preset value, verify that the selector is on CAL position and the instrument read the full scale, otherwise turn TR10 trimmer to calibrate the instrument. Now, it's possible to calibrate the measures using trimmers placed on the measures card that correspond to the requested measure. After the current calibration is possible to calibrate the voltage reading, using a multimeter to read the input voltage values too. VG1, VG2 and VA voltages is naturally measured on the test points and to simulate the equipment working is necessary to refer to voltage values indicated on the relative TABLE D.

FIG. 27 POWER SUPPLIES CONNECTION FOR THE CALIBRATION OF TEST POINT VOLTAGES

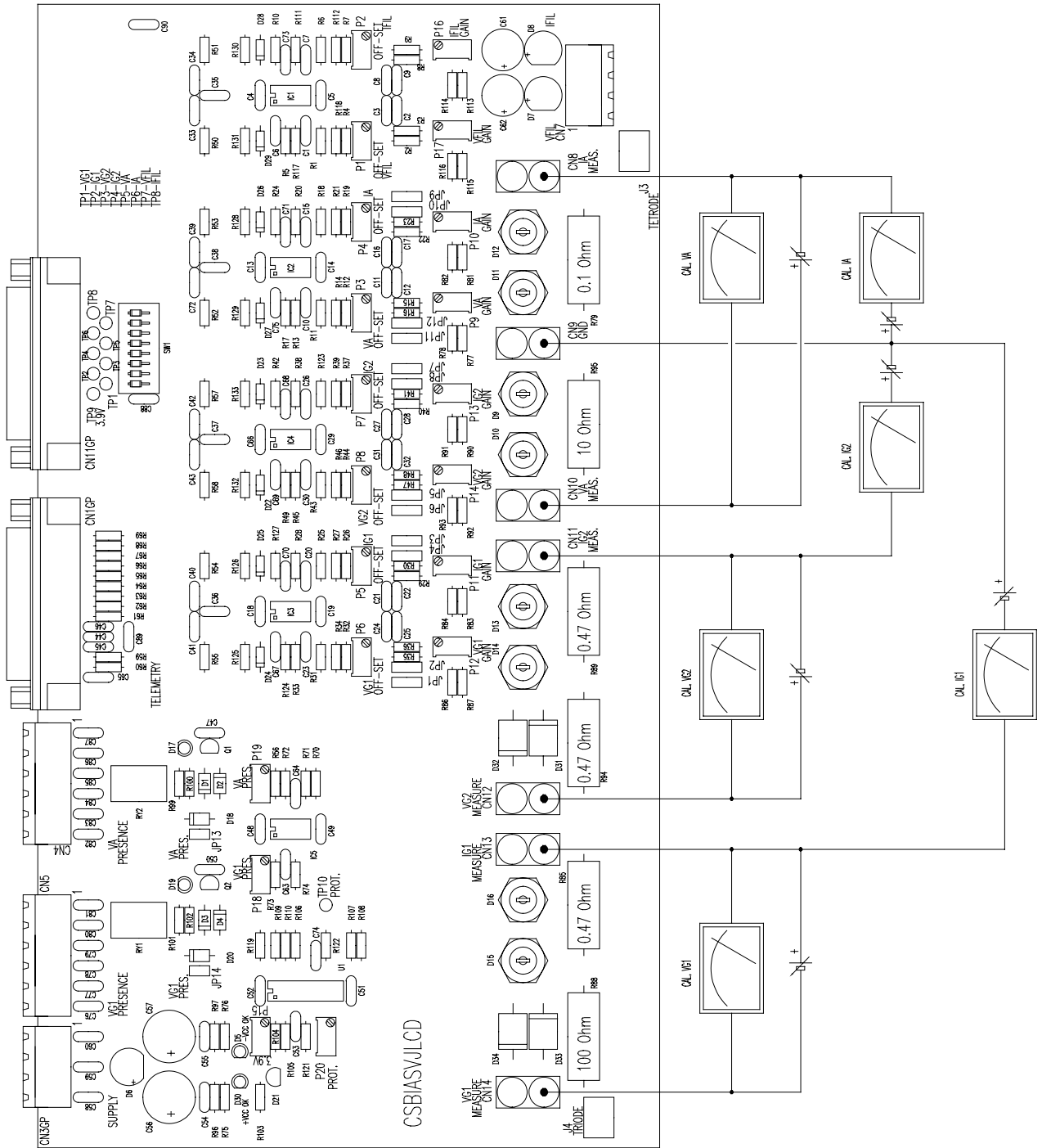

TABLE D - MEASURE TESTS CARD

Model VJ10000-TR	Volt Fil.	Current Fil.	VA	IA	VG1	IG1	VG2	IG2
I° STEP input	3,9 VAC	1,665 VAC	107,0 mV	-	-	-	-	-
II° STEP input	6,250 VAC	1,775 VAC	171,0 mV	249 Mv	141 mV	2,397 VDC	-	-
I° STEP Out Test Point	2,254 VDC	2,639 VDC	2,450 VDC	-	-	-	-	-
II° STEP Out Test Point	3,9 VDC	3,099 VDC	3,9 VDC	3,95 VDC	3,445 mV	3,9 VDC	-	-
I° STEP Strument Measure	3,8 VAC	140 A	5000 VDC	-	-	-	-	-
II° STEP Strument Measure	6,3 VAC	160 A	7500 VDC	2,5 A	57 VDC	500,0 mA	-	-
I° STEP LCD Measure	3,7 VAC	42,0 A	5000 VDC	-	-	-	-	-
II° STEP LCD Measure	6,3 VAC	160,0 A	7500 VDC	1,6 A	57 VDC	500,0 mA	-	-
I° STEP Fluke Measure	3,9 VAC	140 A	-	-	-	-	-	-
II° STEP Fluke Measure	6,250 VAC	160 A	7500 VDC	2,5 A	57 VDC	500,0 mA	-	-

On the measure card there are n°2 trimmer P18 corresponding to VG1 voltage presence and P19 for VA voltage presence.

These two trimmers set the thresholds for the VG1 and IA voltage presence on the equipment.

Once that is been verified the voltages presence, the relays are closed to enable the protection box and leds D17 and D19 are light on to signal the controlled voltage presence.

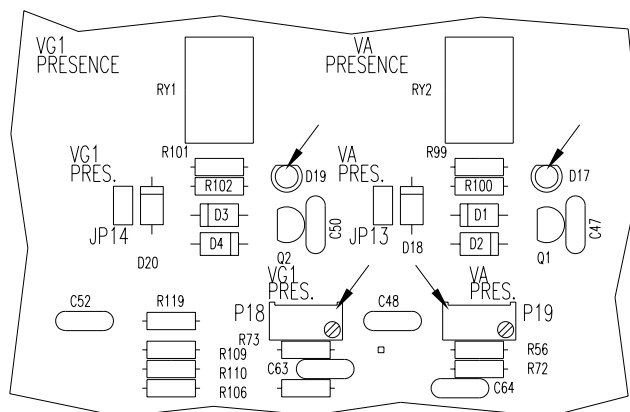

In case that on the equipment is installed a triode tube, the checking of the VG1 is excluded because this voltage is created automatically when the tube is in power and is created inserting the jumper JP14 to have a short circuit so that the starting sequence is ok, otherwise the equipment never go in high tension.

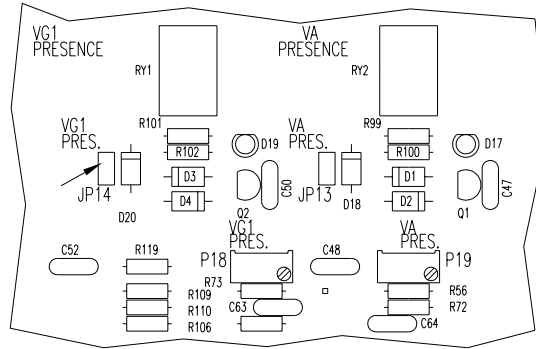

Another possibility to check it, if the protection logic works correctly, is that to generate an adjustable voltage of 3.95 V by trimmer P20 and to measure it on test point TP10.

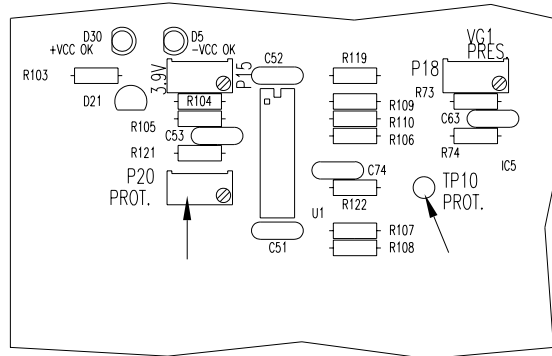

Working on dip switch SW1 it's possible to have the preset tension on the chosen output.

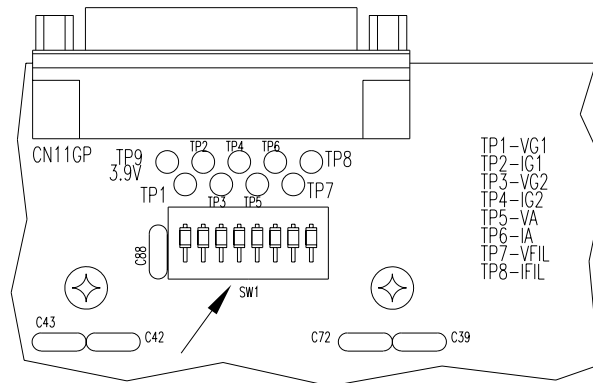

The correspondence on the dip switch SW1 is the following:

SW1	Test Point	Measure
1	TP8	I Filament
2	TP7	V Filament
3	TP6	I Anode
4	TP5	V Anode
5	TP4	IG2
6	TP3	VG2
7	TP2	IG1
8	TP1	VG1

The calibration of the filament voltage and current cannot be executed with power supply, because the measures must be executed in alternate voltage.

To calibrate the filament voltage is necessary to apply on CN7 sockets a voltage like as that of the tube (for example with 3CX15000A7 is necessary a voltage of 6.3V) and through trimmer P17 adjust the Test Point output voltage for the value indicated on the table at TABLE D.

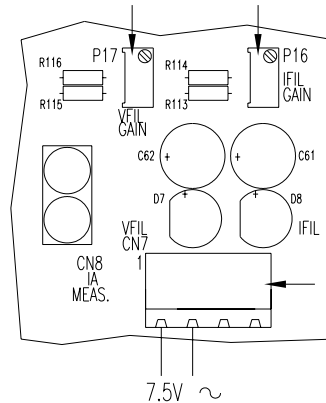

The filament current measure is obtained by a TA and then the voltage is included between 2.5Vac and 3.5Vac.

For the calibration of the trimmer P16 proceed as follows:

- 1) Insert the tube in the socket and close again the RF cavity so that is possible to switch on it
- 2) Place an amperometric clamp so that to include one of the two power supply wires of the filament that are connected to the socket.
- 3) Switch on the equipment and place the selector switch "MIN. FIL. ST.BY" to FULL FIL. position.
- 4) Verify that led FIL 2 is lighted on.
- 5) Verify on the amperometric clamp the absorbed current is that of nominal working of the tube.
- 6) Adjust P16 trimmer until to read on the test point a voltage value of 2,9 Vdc.

If it's impossible to find quickly the voltage level, the protection could go in FAULT for CHECK LIST ERROR; repeat the operation more times until to reach the correct value on the Test Point output as indicated on the measure table TABLE D.

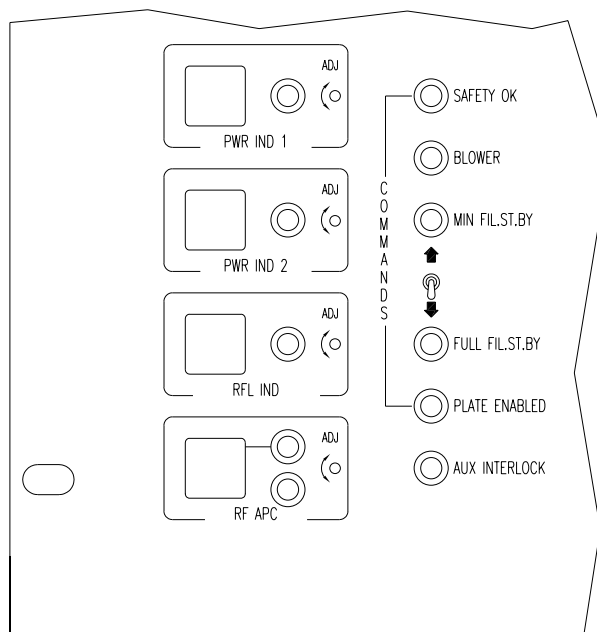



Scheda di controllo dell'amplificatore valvolare a fine collaudo

Data: XX.XX	Cliente: TELECOM	Finale Tipo: VJ 10KW TR	Numero di Serie: XXXXXXXX	Operatore: XXXXX
-------------	------------------	-------------------------	---------------------------	------------------

TENSIONI MISURATE SUI TEST POINT		TENSIONI E CORRENTI VISUALIZZATE DAL MULTIMETRO		SETTAGGI	VALORI
TP1	VG1	3,9V	CAL	POWER GOOD 1	5000W
TP2	IG1	2,1V	SCREEN CURRENT	POWER GOOD 2	2500W
TP3	VG2	-	SCREEN VOLT	SWR WARNIG	500W
TP4	IG2	-	GRID CURR	PWR LOWER	-
TP5	VA	3,4V	GRID VOLT		
TP6	IA	3,2V	PLATE CURR	VALVOLA	<input checked="" type="checkbox"/> SI <input type="checkbox"/> NO
TP7	VFIL	3,3V	PLATE VOLT	PILOTI	<input type="checkbox"/> SI <input checked="" type="checkbox"/> NO
TP8	IFIL	2,89V	FIL CURR	ORA	XX : XX
TP9	CAL	3,9V	FIL VOLT		
TP10	PROT	4,3V	TEMP °C		
			FWD PWR		10KW
			RFL PWR		0W

FIG. 28 REPORT MEASURE

TABLE E - QUIESCENT WORKING PARAMETERS

PARAMETER	3CX15000A7
Anode Current	400-600 mA
Filament Current	160 A
Filament Voltage	6.3 ± 0.37V
Grid 1 Voltage	Automatic polarization
Anode Voltage	7500 V

TABLE F - ADVISABLE EQUIPMENT FOR TEST

INSTRUMENT	ADVISABLE MODEL	SPECIFICATIONS
Non inductive dummy load	Bird 50 Ohm	P ≥ 10 KW
By-Pass Wattmeter with sample	Bird Mod. 4715-200	50 Ohm
Power Supply	HP6002A	0-50 V, 0-10 A

TABLE G - VOLTAGE STABILIZER PARAMETERS

Model	STM0K9/G codice ST1502
Input Power	max. 900 VA
Input Current	max. 4,1 A
Sensibility	adjustable from 0.5 to 5 %
Input Voltage Variation	max. ± 15 %
Efficiency	98 %
Stabilization	with a precision independent from load and power factor (cosφ)
Harmonic Distorsion	Not appreciable
Answer speed	> 30 V/sec (33 msec/V)
Precision	± 0.5 %
Dimensions	12.38" (315 mm) W 5.97" (152 mm) D 5.50" (140 mm) H
Working temperature	da - 10°C a + 45°C
Weight	17.6 Lbs (8 Kg)

CHAPTER 5

MAINTENANCE

5.1 SAFETY RULES

PAY ATTENTION ! PAY ATTENTION ! PAY ATTENTION ! PAY ATTENTION !

When the amplifier is working on, and the rear panel is been removed, inside of equipment are present dangerous high tensions. Use isolated tools for any type of adjustment and don't touch any internal components of equipment when this is switched on. Verify that the equipment internal high tensions are been short circuited (eventually use a switch hook). Verify to disconnect the mains voltage of the amplifier before to execute any maintenance operations.

MAINTENANCE FIRST LEVEL

5.2 SAFETY RULES

Only routine maintenance that is necessary for amplifier are the periodic checking of the fans, the replacing of the air filter and the cleaning inside the tube cavity and the air filter. The periodicity of this maintenance depends from the working conditions of equipment, enviromental temperature, the dust level of the air, humidity. It's advisable to execute a preventive checking each three months and to replace the blowers that has some problems as noise or friction. Then, at regular period, is necessary the replacing of the tube. The numbers of the tube life hours depends from the working conditions, example: mains voltage with variations greater than $\pm 5\%$, environmental temperature greater than 30°C , high humidity, dust presence and not corrected adjustment of the amplifier, are the causing of high reduction of the tube life.

MAINTENANCE SECOND LEVEL

5.3 MODULES REPLACING

NOTE: TO REMOUNTING THE MODULES EXECUTE THE PROCEDURE WITH INVERSE SEQUENCE.

NOTE: THESE OPERATIONS MUST BE EXECUTED BY VERY QUALIFIED TECHNICIANS AND EQUIPPED

WITH NECESSARY INSTRUMENTS.

UNCORRECTED OPERATIONS CAN CUASE A SERIOUS DAMAGE OF THE EQUIPMENT AND CAUSE AUTOMATICALLY THE RESOLVING OF THE WARRANTY.

5.4 TUBE REPLACING

- 1) Through the command PLATE, move the sliding plane with fingers until the upper end position (threshold bars completely extracted)..
- 2) Disconnect the mains voltage from equipment.
- 3) Verify that the tube that must be replaced is cold sufficiently to avoid very serious burns.
- 4) Verify that all internal tensions are decreased to 0 V, eventually short circuit by a switch hook.
- 5) Open the hinged front panel unscrewing the relative screws (FIG. 16).
- 6) Unscrew the fixing screws of the internal panel of the RF cavity.
- 7) Loosen the plate ring and raise it until the top position and then fix it in this position.
- 8) Remove the high tension block from the top part of the tube.
- 9) Remove the tube from its socket, exerting a perpendicular traction from the base (upwards) and contemporary turn the tube to right and left side to reduce the frictions.
- 10) To remount the tube executed the same operations from point 6) of the 3.3. paragraph "Tube mounting".

5.5 AIR FILTER REPLACING

- 1) It isn't necessary to switch off the equipment.
- 2) Open the rear grid of the air filter (FIG. 2) unscrewing the relative fixing screws.
- 3) Replace the air filter (felt), cleaning very accurately the internal part. Close the rear grid of the air filter with its screws

CHAPTER 6

ADJUSTMENTS

NOTE: THESE OPERATIONS MUST BE EXECUTED BY VERY QUALIFIED TECHNICIANS AND EQUIPPED WITH NECESSARY INSTRUMENTS. UNCORRECTED OPERATIONS CAN CAUSE A SERIOUS DAMAGE OF THE EQUIPMENT AND CAUSE AUTOMATICALLY THE RESOLVING OF THE WARRANTY.

6.1 FREQUENCY CHANGE

To execute a frequency change on a tube amplifier, it's necessary to execute the following operations:

- 1) Connect, at first time, only the exciter (30 W max, example PTX30-UHT) to the input of the VJ5000 amplifier, excluding eventual drivers.
- 2) Adjust the power control of the exciter for minimum output power.
- 3) Switch on the amplifier and preset the command PLATE in function of the working frequency.
- 4) After the heating time and obtained the exciter locking on the working frequency, increase the output power of the exciter until 20 W.
- 5) Enable and act on INPUT LOAD and INPUT TUNE commands to reset the input reflected power.
- 6) The last operation will be able to cause an increasing of the anode current; now, act on OUPUT TUNE and OUPUT LOAD commands to obtain the maximum output power readable on the wattmeter. Place the DIR/REF selector on DIR position. Verify that the threshold bar move to internal position of RF cavity each time that we are near to the 108 MHz frequency and to external position respect the cavity when we are near to 87.5 MHz frequency.
- 7) Increase the input power and adjust the OUPUT TUNE and OUPUT LOAD commands to obtain again the maximum output power.
- 8) Replace at the minimum value the output power of the exciter and switch off it.
- 9) Insert the driver between the exciter and amplifier.
- 10) Switch on both the exciter and the driver.
- 11) Increase the output power of the exciter and execute again a fine OUPUT LOAD and OUPUT TUNE adjustment and INPUT LOAD and INPUT TUNE adjustment until to obtain 10 KW of output power.
- 12) When the 10 KW is obtained, execute small adjustment with the same procedure until to obtain the same output power with the minimum value of the plate absorption, eventually decrease the exciter power.

APPENDIX A

CIRCUIT DIAGRAMS AND LAYOUTS

This section contains circuit diagrams and alyouts of the module which composing the equipment

FIG. 29 POWER SUPPLY SOCKET

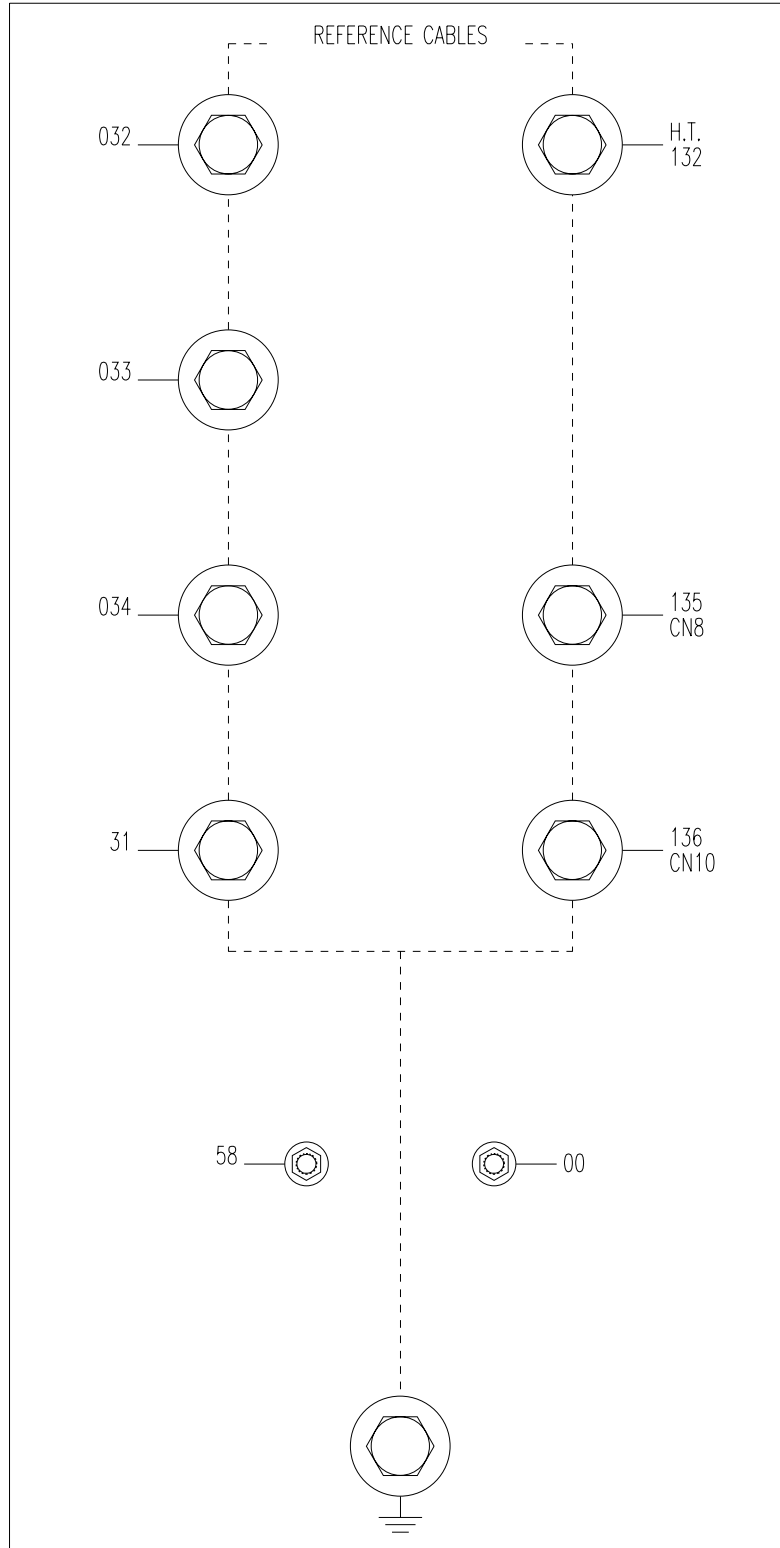

FIG. 30 ANODE TENSION TRANSFORMER SOCKET

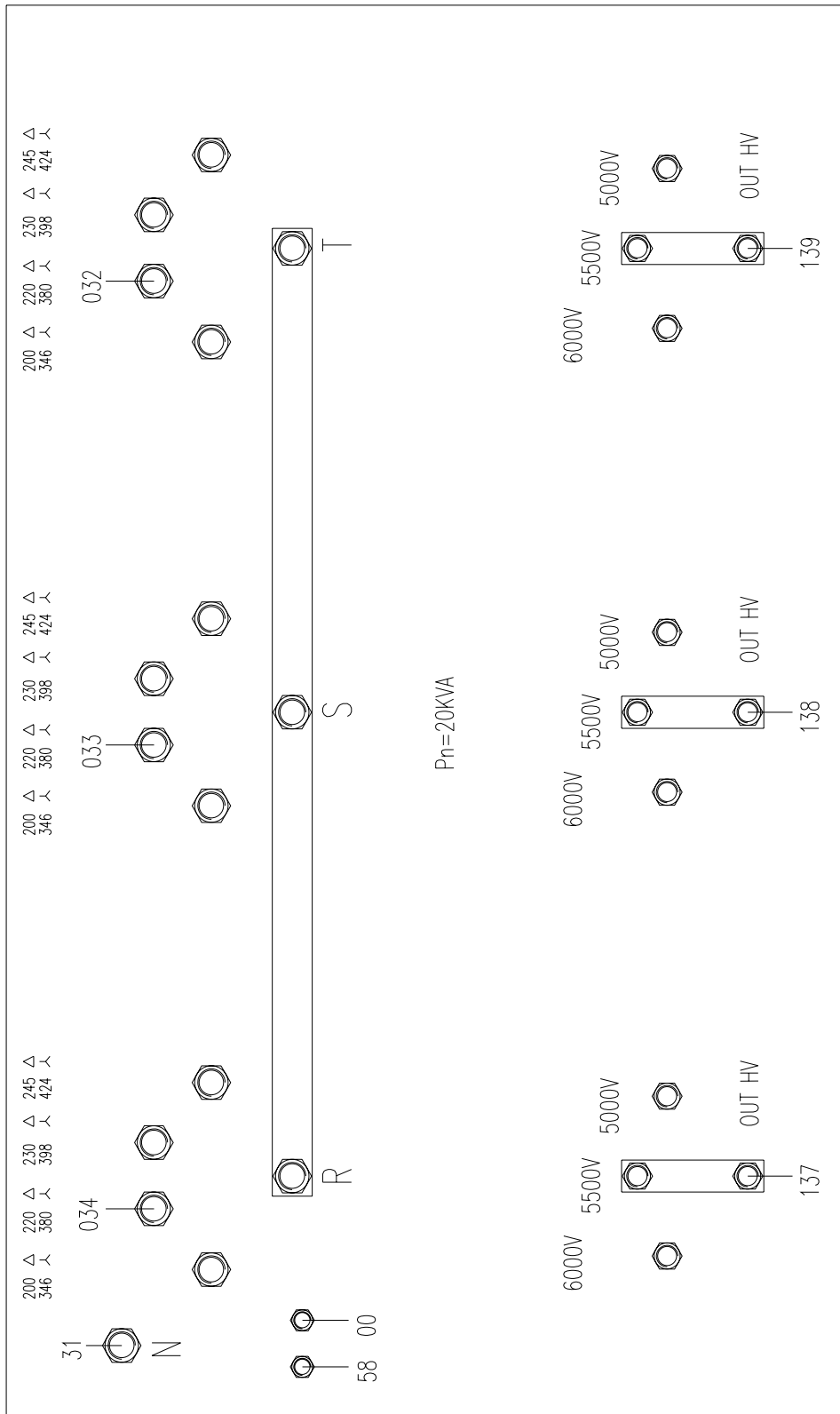

FIG. 31 RACK POWER SUPPLY BASE

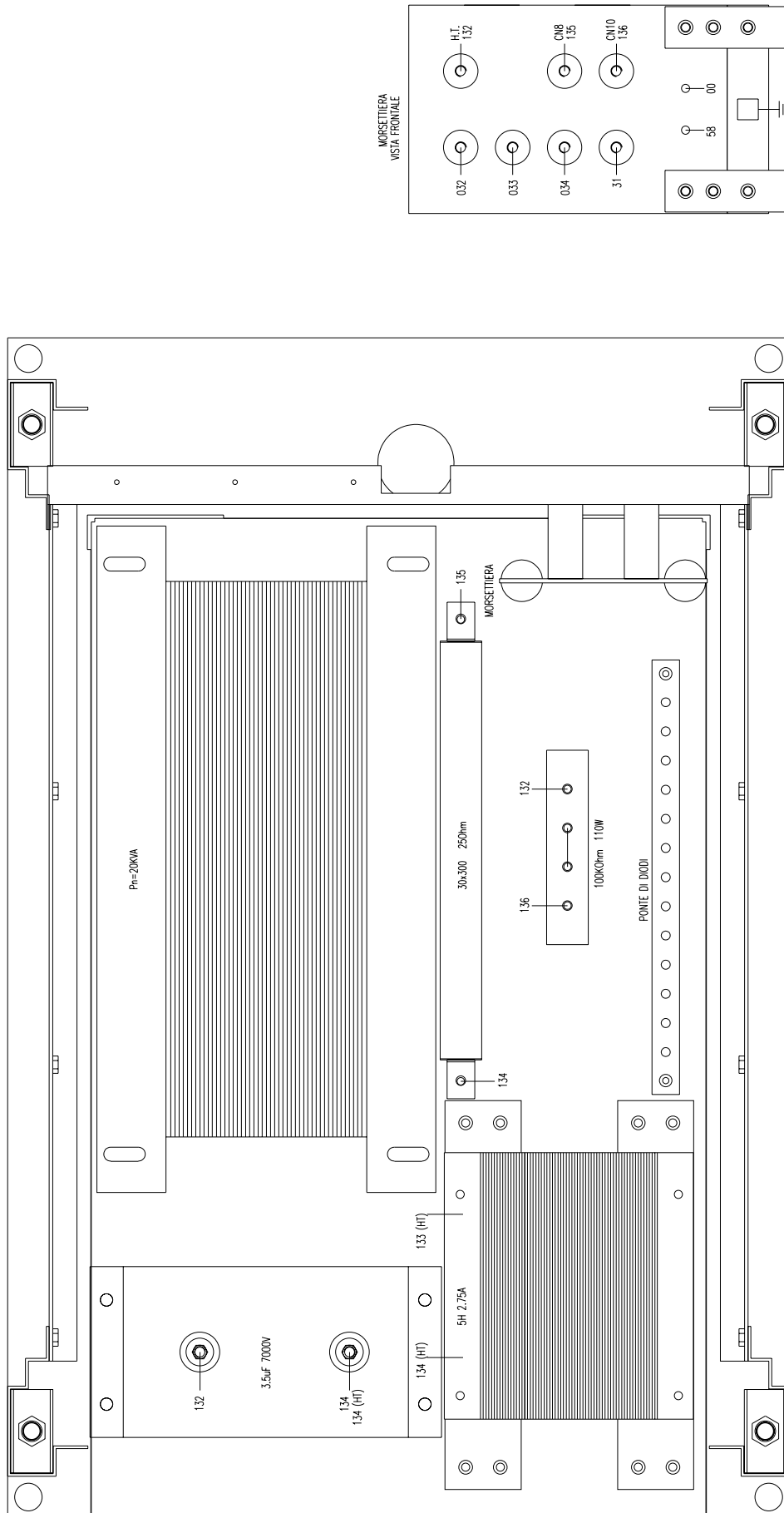

FIG. 32 HIGH TENSION PANEL

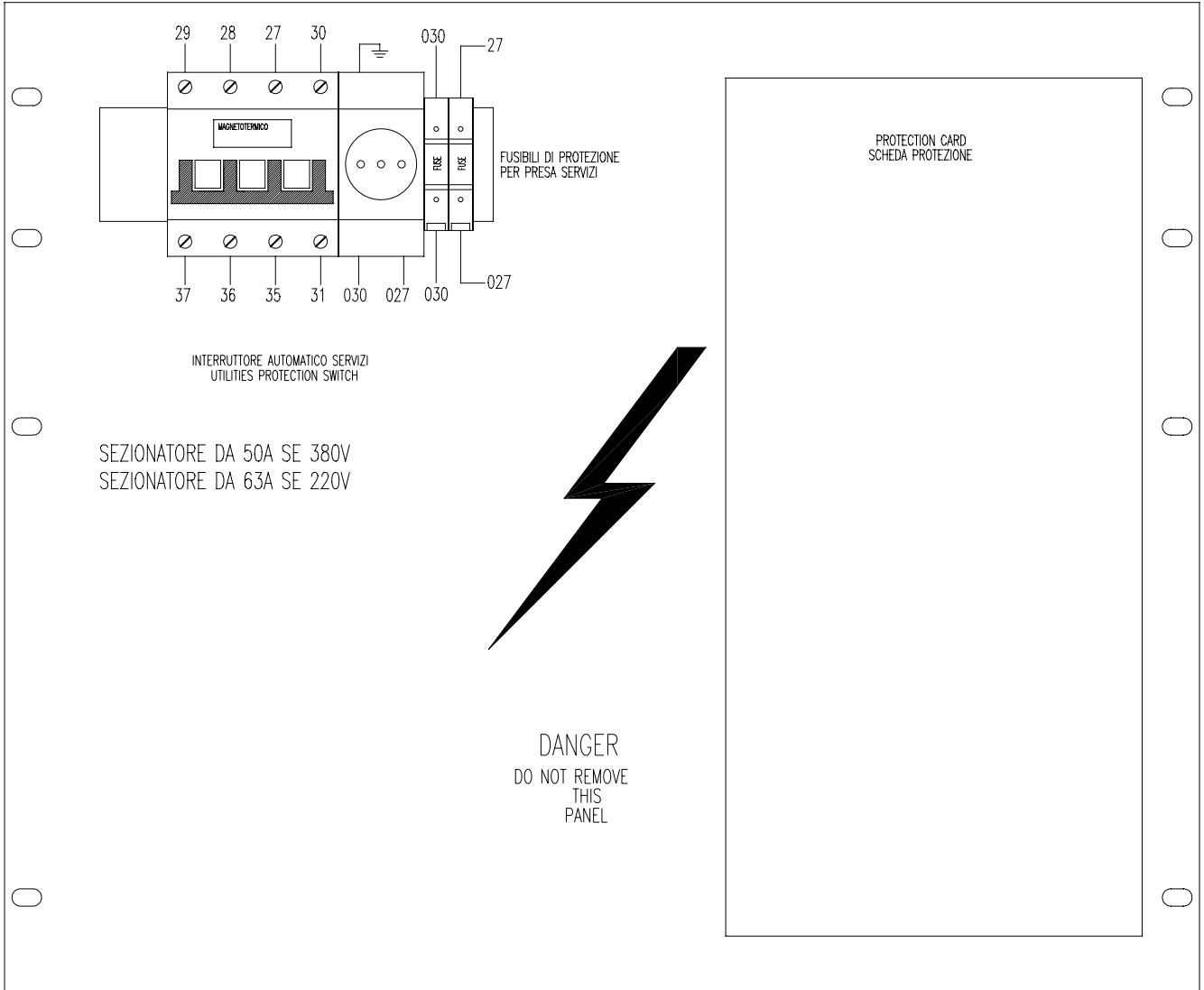
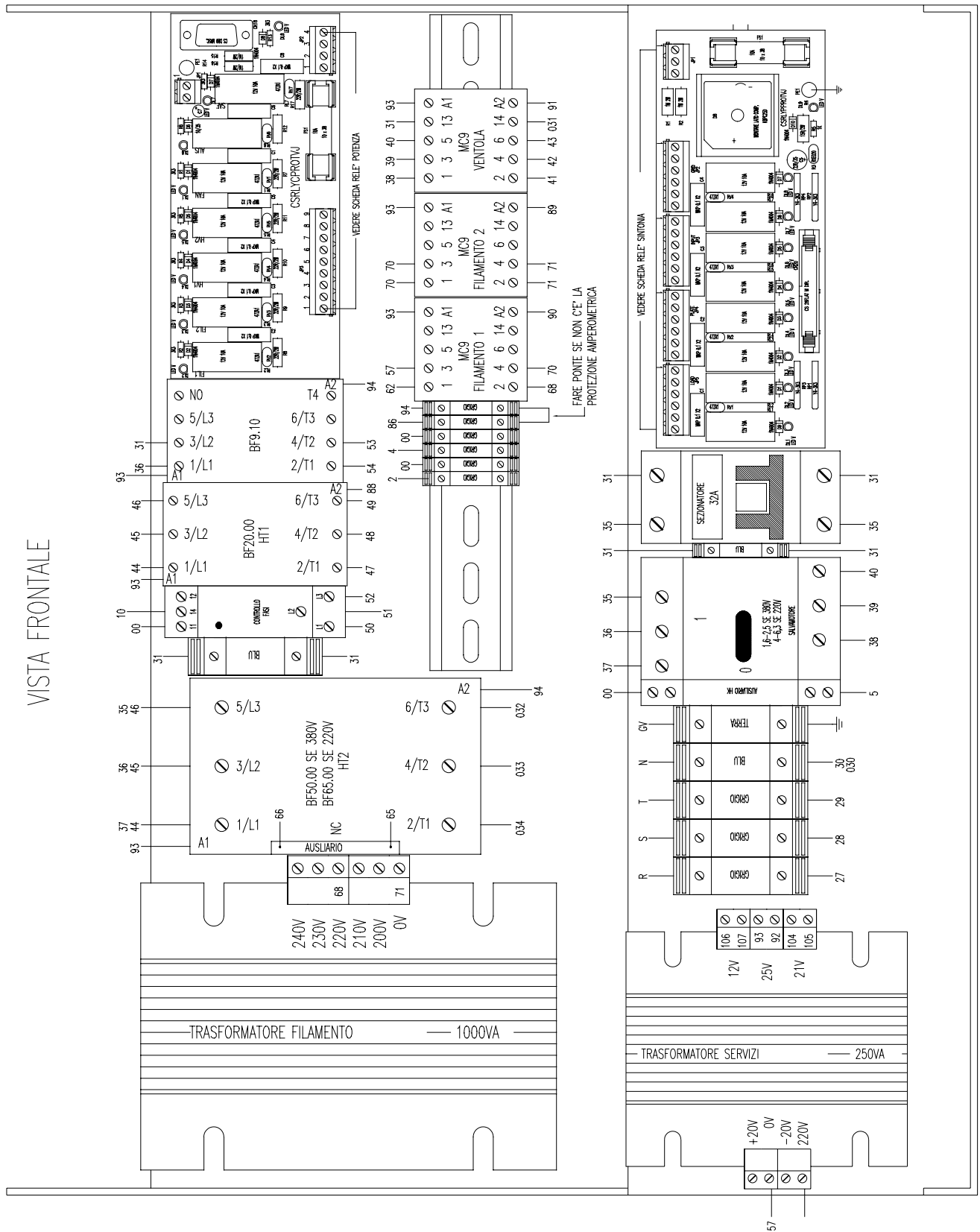
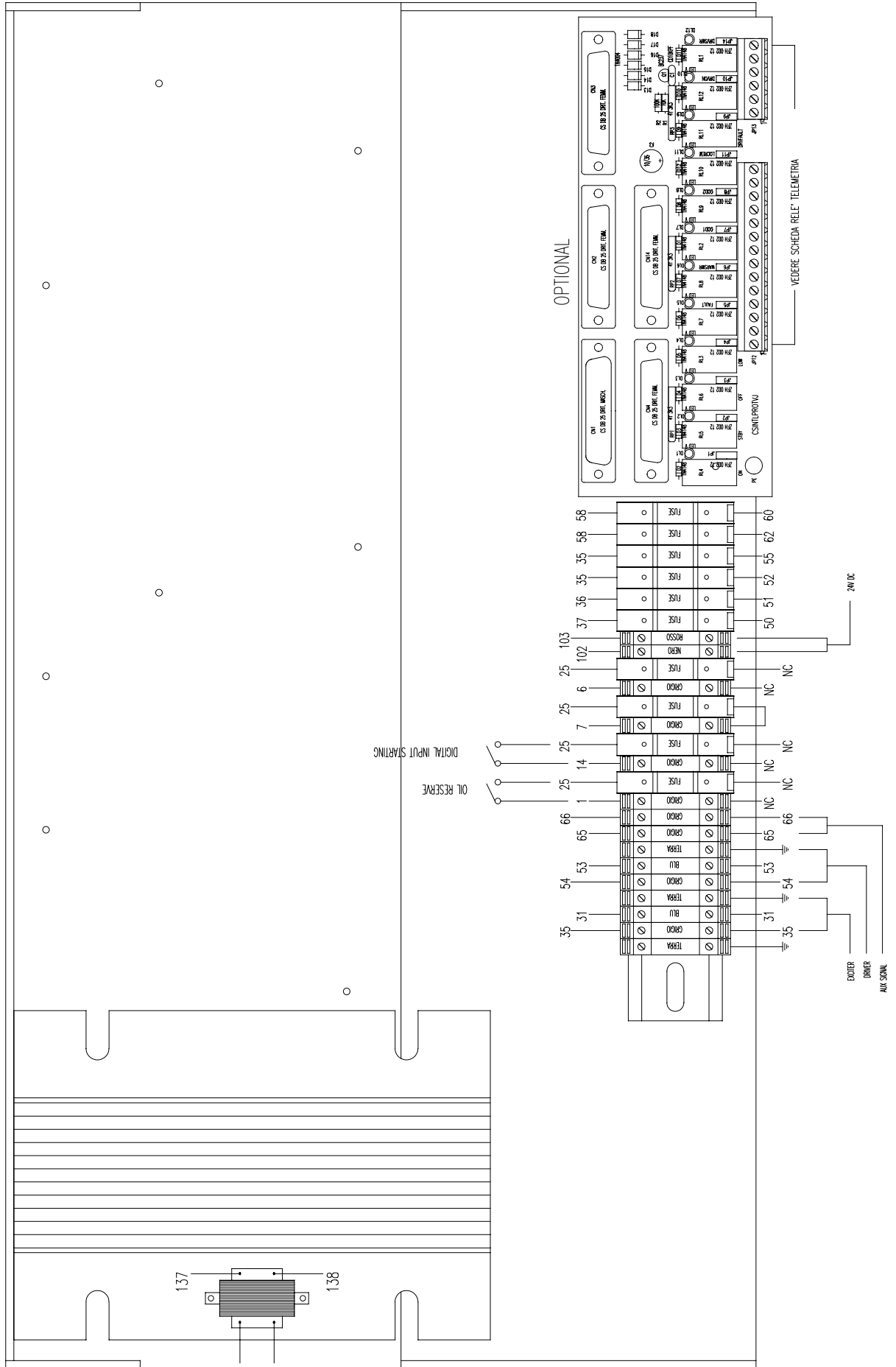

FIG. 33 ELECTROMECHANICAL PLANE (TRIODE)



VISTA SUPERIORE



VISTA POSTERIORE

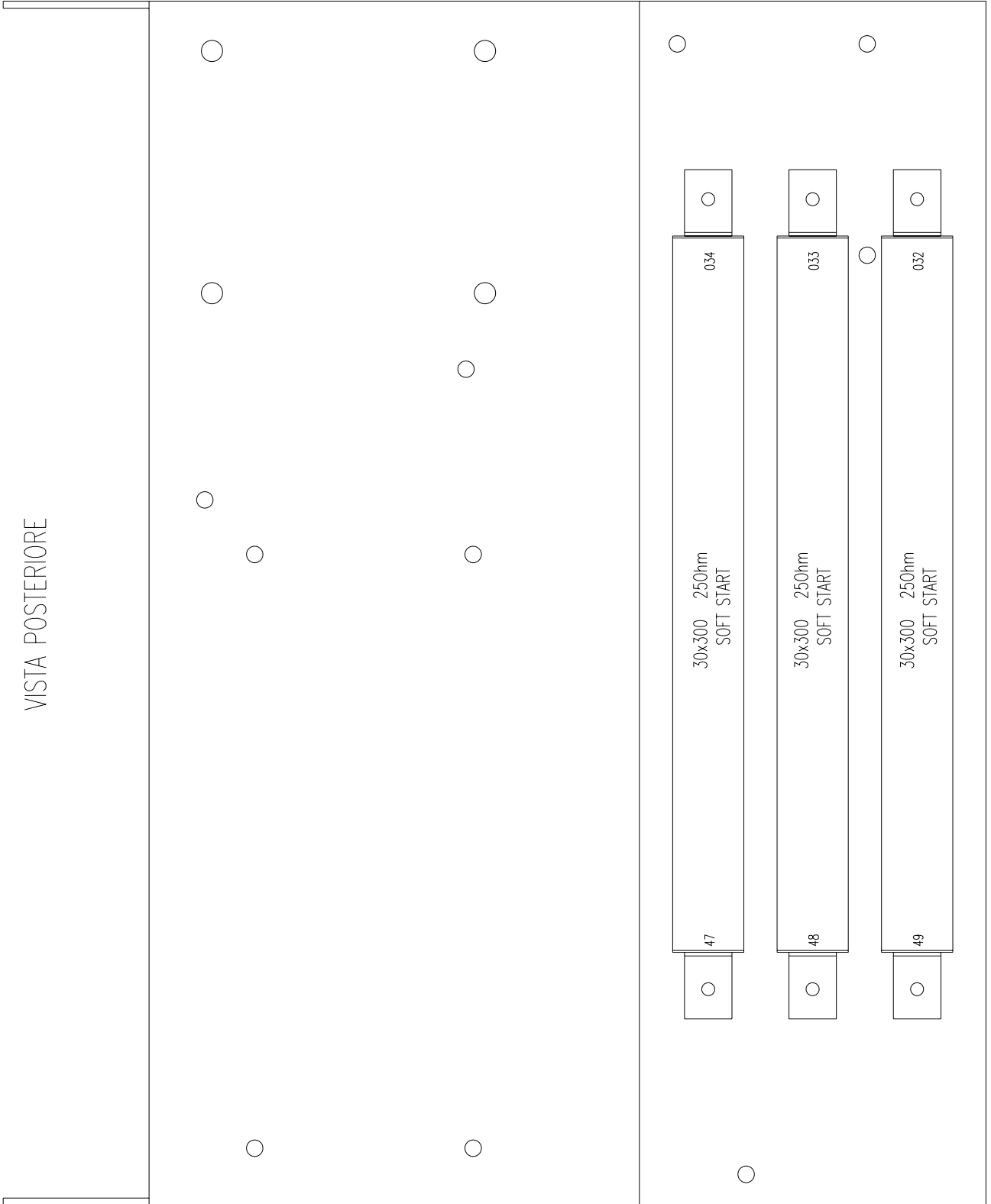

FIG. 34 RESISTENZE DI SOFT-START E POLARIZZAZIONE VALVOLA

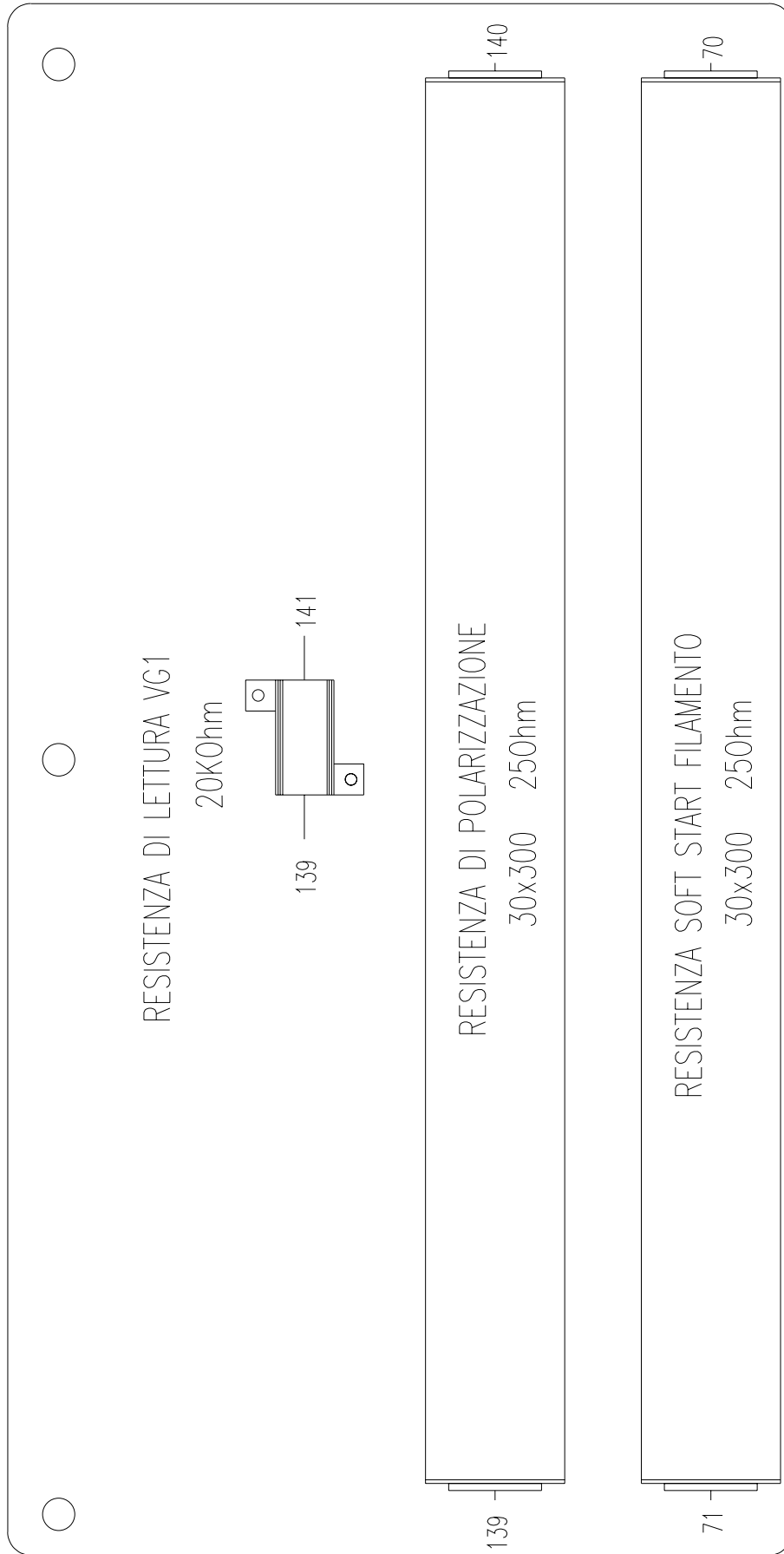

FIG. 35 TUBE AMPLIFIERS PROTECTIONS CARD

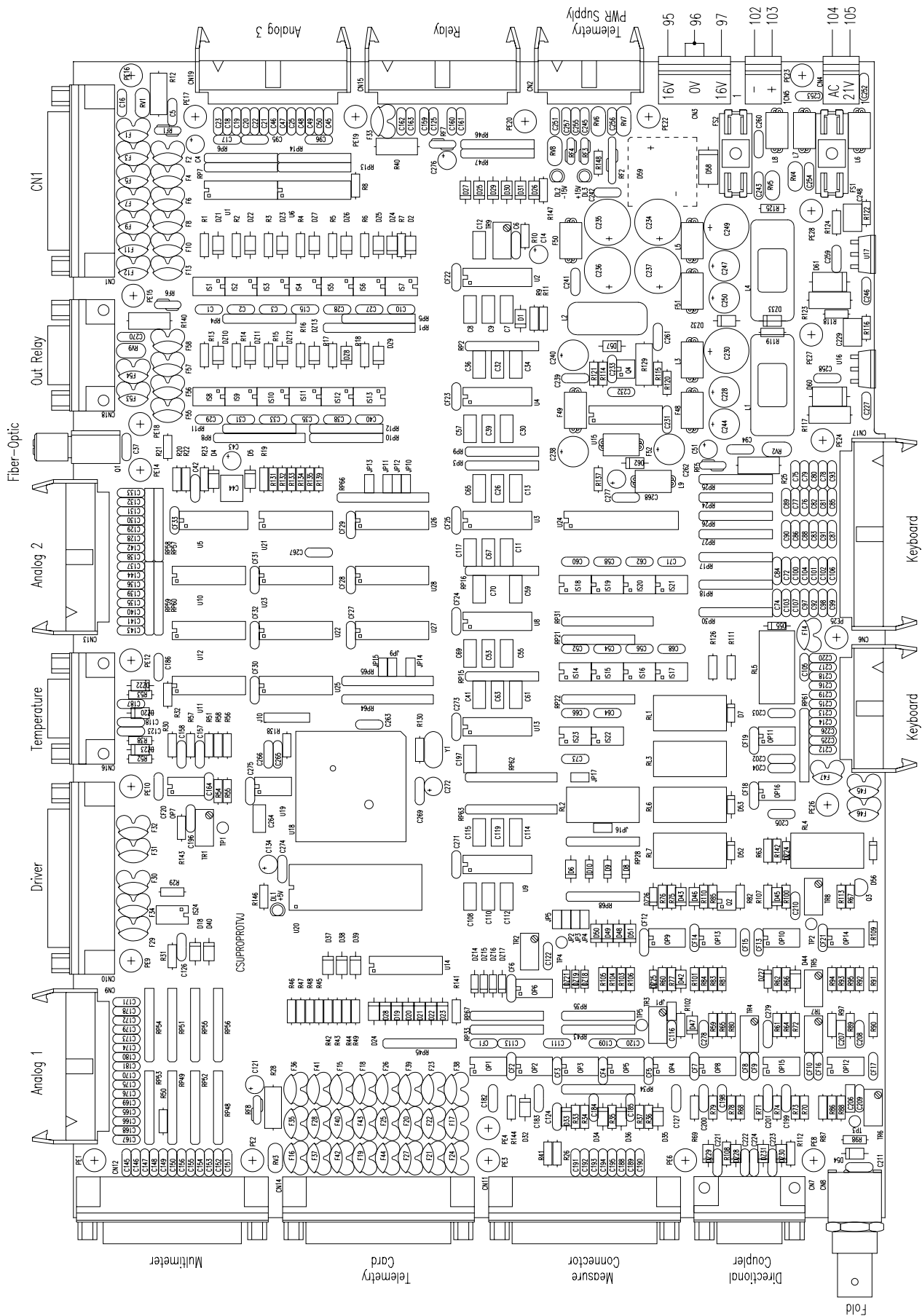
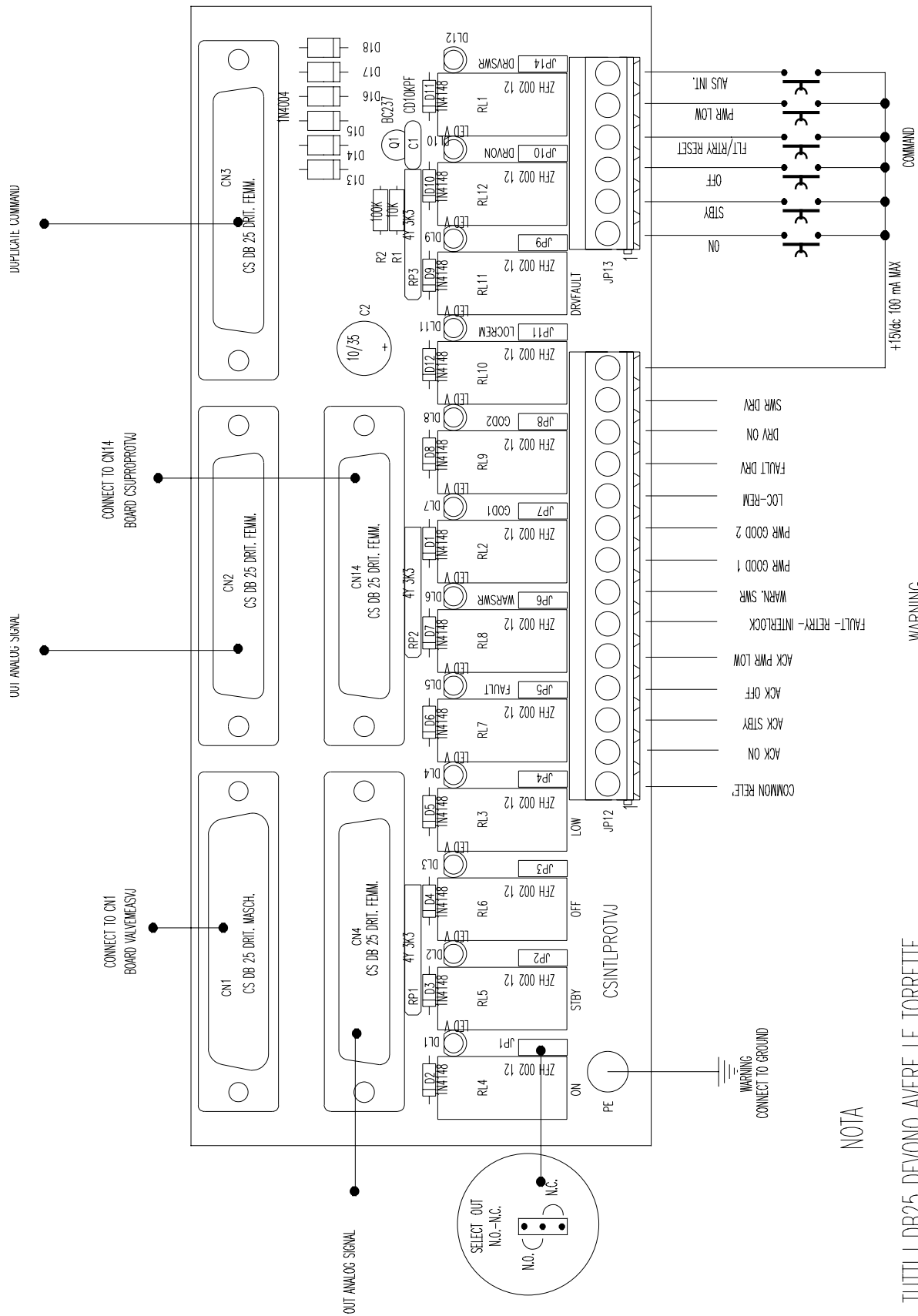

FIG. 38 TELEMETRY INTERFACE CARD



NOTA

TUTTI I DB25 DEVONO AVERE LE TORRETTE

WARNING
MAX TOTAL CURRENT OUT 2A

FIG. 39 MEASURES CALIBRATION CARD

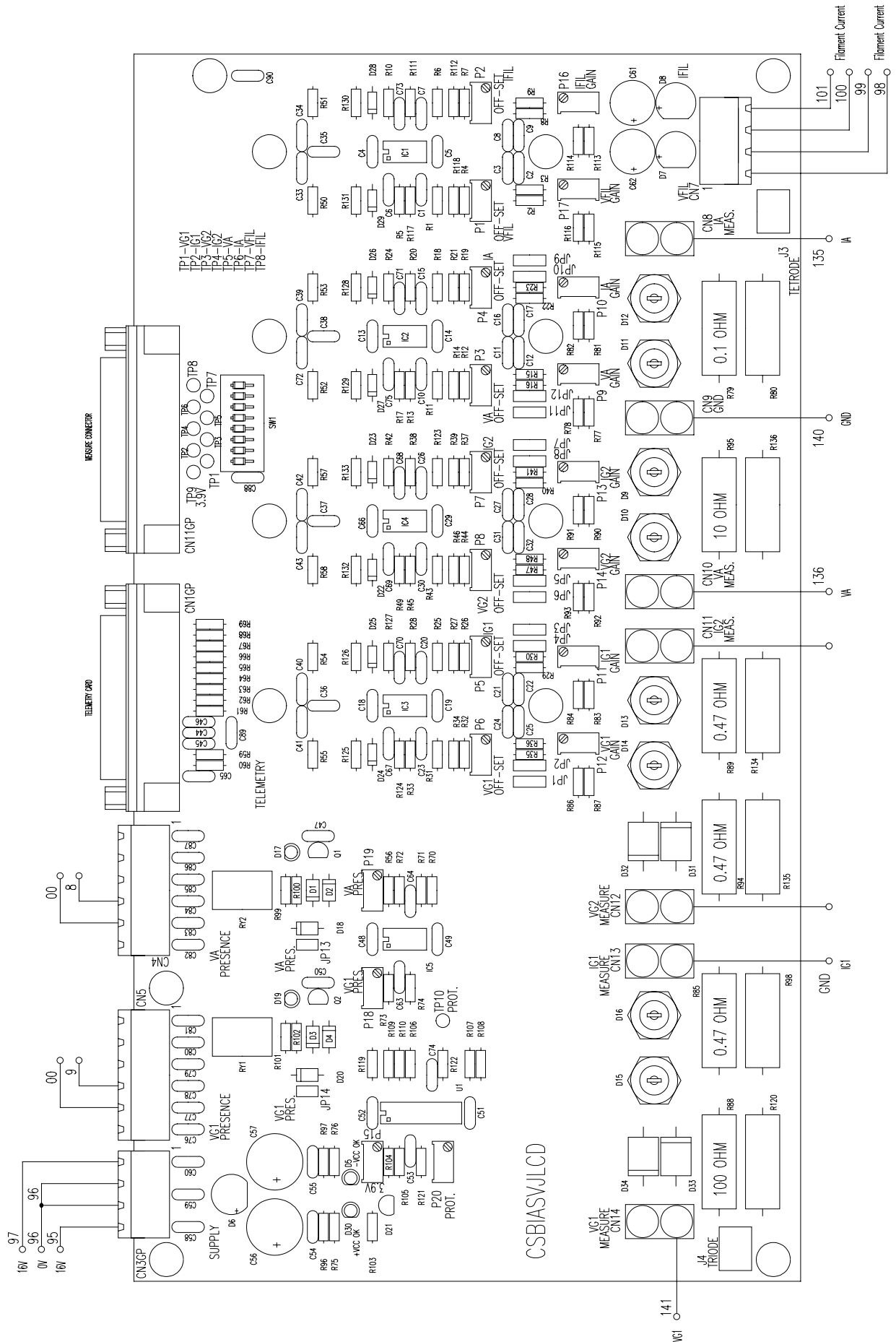
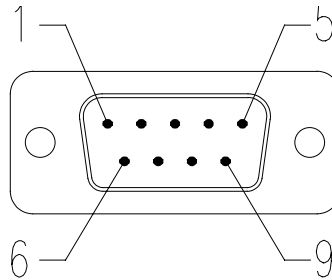

FIG. 40 THERMAL STROBE CONNECTOR



9 Pin Male Connector

Connettore per Sonda Termica		
Pin n°	Descrizione	Colore Cavo
1	Segnale (-)	Marrone
2	Segnale (+)	Verde
3	Non Connesso	
4	Non Connesso	
5	+VDC	Bianco
6	-VDC	Giallo
7	Non Connesso	
8	Non Connesso	
9	Schermo	Calza

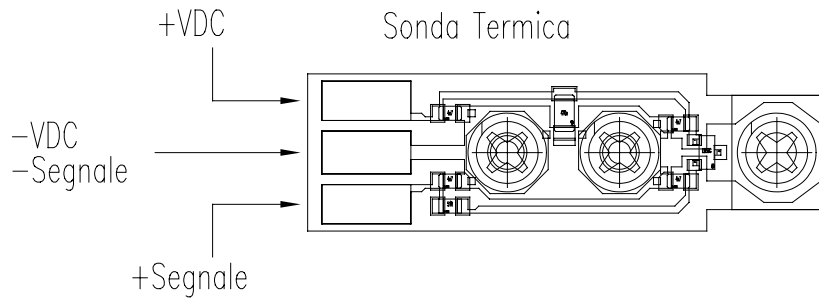
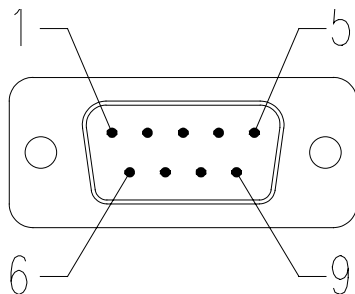

FIG. 41 P.W.R. MEASURE CONNECTOR



9 Pin Male Connector

Connettore per la misura di P.W.R.		
Pin n°	Descrizione	Colore Cavo
1	N.C.	
2	N.C.	
3	N.C.	
4	N.C.	
5	SCHERMO	
6	P. DIRETTA (-)	Rosso/Giallo
7	P. DIRETTA (+)	Blu/Marrone
8	P. RIFLESSA (-)	Verde
9	P. RIFLESSA (+)	Bianco

FIG. 42 12 CBUS CONNECTOR FOR TELEMETRY BOX

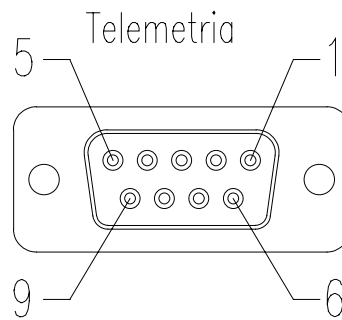

9 Pin Female Connector

1 ² CBUS Scatola Telemetria		
Pin n°	Descrizione	Colore Cavo
1	/	
2	SEGNALE	Bianco
3	SEGNALE	Marrone
4	/	
5	GND	
6	/	
7	/	
8	/	
9	/	

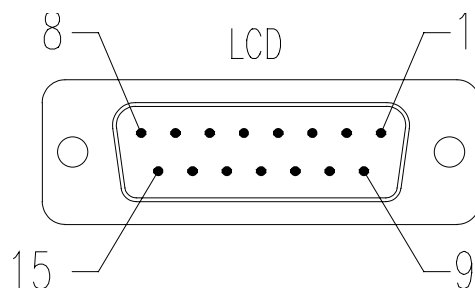
FIG. 43 PTXLCD CONNECTOR

15 Pin Male Connector

Connettore PTX30LCD		
Pin n°	Descrizione	Colore Cavo
1	/	
2	CONTROLLO POTENZA	RG58
3	GND	
4	SEGNALE	Bianco
5	/	
6	/	
7	/	
8	/	
9	GND	
10	/	
11	SEGNALE	Marrone
12	/	
13	/	
14	/	
15	/	

FIG. 44 LOW VOLTAGE CIRCUIT DIAGRAM

FIG. 45 THREE-PHASES CIRCUIT DIAGRAM

FIG. 46 MEASURES AND ALLARMS CIRCUIT DIAGRAM

FIG. 47 ELECTRIC SCHEMES

© Copyright 2001

R.V.R. Elettronica S.p.a. (Bo)
Via del Fonditore 2/2c - 40138 - Bologna (Italy)
Telephone: + 39 - 51 - 6010506
Fax: + 39 - 51 - 6011104
e-mail: info@rvr.it
www.rvr.it

Printed and bound in Italy. All rights reserved. No part of this manual may be reproduced or utilized in any form or by any means, electronic or mechanical, including photocopying, recording,

or by any information storage and retrieval system, without permission in writing from the publisher.